

Liebe Kunden,

seit 1990 ist Kundenzufriedenheit unser oberstes Ziel. Daher setzen wir immer höhere Maßstäbe, um Ihnen hochqualitative Produkte aus Edelstahl, Kunstschmiedeeisen, Messing, Alu und Zamak mit einem exzellenten Preis-Leistungsverhältnis anzubieten.

Kaufen auch Sie direkt von der Quelle.

AKBAS ... von Profis für Profis !

Inhalt

Edelstahl V2A

Rohrabschluss	6-8
Zierteile	8
Kugel	9
Querstabhalter	10-11
Handlaufzubehör	12-15
Abdeckrosetten	16
Vordach-Konsole	18-20
Klemmbefestigungen	21-29
Wandbefestigung	30-31
Stanzteile	32-35
Rohrbögen	36-37
Steckfittings	38-39
Vierkant-Steckfittings	40
Holzhandlaufverbinder	41
Schlossgehäuse, Gegenkästen .	42-44
Torbänder	45
Türbänder, Scharniere	46-49
Türdrücker	50-54
Stossgriffe	55
Designstäbe	56-57
Edelstahl-Rohre	58
Seilsystem und Zubehör	59

Edelstahl V4A

Drahtseile und Zubehör	60-62
Ketten und Zubehör	63
Steckfittings	64
Rohrabschluss.....	65
Handlaufzubehör.....	66
Stanzteile.....	67
Klemmbefestigungen	68-69

Zink

Klemmbefestigungen	26-29
--------------------------	-------

Messing

Rohrabschlussstopfen	70
Kugel	70
Abdeckrosetten	71
Handlaufzubehör	71
Zierteile	71

Schmiedeeisen

Ankerplatten	72-75
Rohrabschlussstopfen	76
Abdeckrosetten	76
Kugel	77
Schnörkel	78-83
Designstäbe	84-85
U- Bunde	85
Zierstäbe	86-93
Schmiedestäbe	94-95
Anfangsstäbe	96
Stangenmaterial	97
Handlaufzubehör	97-98
Korbstäbe	99-100
Zierspitzen & Lanzenstäbe	101
Rosetten	102
Schmiedestücke & Zierteile	102
Ringe	103
Ornamente - Zierblätter	103-105
Tür- und Torbogen	106

Drückergarnituren	107
Schlossblenden	107
Torbänder	108-109
Schiebetor-System	110-115
Torführungsbügel	112
Schiebetorrollen	113
Schloss & Zubehör	116-121

Aluminium

Aluminium-Beschläge	122-124
---------------------------	---------

Hilfs- und Befestigungsmittel

V4A Betonschrauben,	
Stahlbolzen	125-126
Verbundmörtel, Dübel	127
Schrauben	128-129
Hebelnietzange und Zubehör	130
Schleifmittel	131
Edelstahlpflege, Klebstoffe	132
Farben	133

Liefer- und Zahlungs-Bedingungen

.....	134
-------	-----



Schmiedeeisen & Metallwaren

Dear Customers,

Since the year 1990 customer satisfaction has always been our prime principle. With this principle while continuously providing you with top quality stainless steel, wrought iron, brass, aluminium and zamak products, we are moving forward by always setting newer and higher goals to achieve.

Please procure the product from the source.

AKBAS From Professionals To Professionals !

Contents

Stainless Steel V2A

End caps	6-8
Accessories	8
Spheres	9
Bar holders	10-11
Handrail accessories	12-15
Cover plates	16
Canopy Bracket	18-20
Glass clamps	21-29
Side mounted bases	30-31
Plates	32-35
Curved tubes	36-37
Tube fittings	38-39
Square tube fittings	40
Connectors for wood handrail	41
Locking and striking cases	42-44
Door Hinges	45
Joints V2A stainless steel 304	46-49
Lever handle	50-54
Pull handles	55
Design bars	56-57
Stainless steel pipes	58
Wire rope and chain systems	59

Stainless Steel V4A

Wire rope and accessories	60-62
Chains and accessories	63
Tube fittings	64

Ena caps	65
Handrail accessories	66
Plates	67
Glass clamp	68-69

Zinc

Glass clamps	26-29
--------------------	-------

Brass

End caps	70
Spheres	70
Cover plates	71
Handrail accessories	71
Accessories	71

Wrought iron

Anchor plates	72-75
End caps	76
Cover plates	76
Spheres	77
Scrolls	78-83
Design bars	84-85
U-Collars	85
Ornamental balusters	86-93
Forged balusters	94-95
Starting posts	96
Bar stock	97
Handrail accessories	98
Convex bar	99-100

Spears & Lance Bars	101
Forged rosettes	102
Forgings & Accessories	102
Rings	103
Ornaments - Leaves	103-105
Door & gate curves	106
Wrought iron handles	107
Wrought iron lock plates	107
Door hinges	108-109
Sliding gate system	110-115
Wheels	113
Locks & Accessories	116-121

Aluminium

Aluminium handles	122-124
-------------------------	---------

Additives & fasteners

V4A screws, Through bolt anchors	125-126
Polyester mortar, Plugs	127
Screws	128-129
Rivet pliers & Accessories	130
Abrasives	131
Stainless steel care, Adhesives	132
Paints	133

Delivery and payment conditions

.....	134
-------	-----

Chères nos clients,

Depuis 1990, la satisfaction de client est notre principe fondamental. Lors que nous vous présentons toujours les produits d'acier inoxydable, le fer forgé, le laiton, l'aluminium et le mat de zinc à la plus haute qualité avec ce principe, nous continuons nos travaux en déterminant nous-mêmes les cibles nouvelles à la haute échelle.

Vous assurez le produit de sa source.

AKBAS Aux professionnels de professionnel !

Sommaire

Inox V2A

Embout de fermeture	6-8
Accessoires	8
Sphères	9
Supports transversaux	10-11
Access. de main-courantes	12-15
Rosaces	16
Auvent en acier inox	18-20
Pinces de vitre	21-29
Articles de fixation	30-31
Platines	32-35
Tubes incurvés	36-37
Raccords	38-39
Carré Raccords	40
Connecteur pour main courante en bois	41
Boîtiers de serrure et gâches	42-44
Gonds	45
Joints V2A acier inoxydable 304	46-49
Poignée de porte	50-54
Poignées fixes	55
Barreaux design	56-57
Tube en inox	58
Fixations et accessoires nautiques	59

Inox V4A

Cordages acier et équipements	60-62
Chaînes et équipements	63
Raccords	64

Embout de fermeture	65
Accessoires de main-courantes	66
Platines	67
Pince de vitre	68-69

Zinc

Pinces de vitre	26-29
-----------------------	-------

Laiton

Embout de fermeture	70
Sphères	70
Rosaces	71
Accessoires de main-courantes	71
Accessoires	71

Fer forgé

Platines de fixation	72-75
Embout de fermeture	76
Rosaces	76
Sphères	77
Volutes	78-83
Barreaux design	84-85
Colliers en U	85
Balustres	86-93
Balustres forgées	94-95
Barreaux de départ	96
Barreaux divers	97
Accessoires de main-courantes	98

Barreau galbé	99-100
Fers de lance	101
Rosettes forgées	102
Accessoires en fer forgé	102
Anneaux	103
Ornements - Feuilles	103-105
Arcs pour portes et portails	106
Poignées en fer forgé	107
Plaques de serrure en fer forgé	107
Gonds	108-109
Système porte	110-115
Galets	113
Serrures & Accessoires	116-121

Aluminium

Poignées en aluminium	122-124
-----------------------------	---------

Autres articles de montage

Vis inox, Goujon en acier	125-126
Mortier polyester, Chevilles	127
Vis	128-129
Pince a rivet et accessoires	130
Abrasifs	131
Soins en acier inoxydable, Adhésifs	132
Peintures	133

Conditions de livraison et de paiement

.....	134
-------	-----

E-mail: info@akbas-schmiedeeisen.de, www.akbas-schmiedeeisen.de

Tel: +49(0) 61 44 33 05-0, Fax: +49(0) 61 44 33 05-15

Tel: +33.3.68680131, E-mail: vente@akbas-schmiedeeisen.de, Tel: +44.151.6018946, E-mail: sales@akbas-schmiedeeisen.de

AK INOX

Rohrabschluss / Embout de fermeture / End cap

Rohrabschlussstopfen, gewölbt
Embout de fermeture, Bombé
End cap, Cambered



≥ 0,89
€/Stk./pcs.



Mit Neuen Abmessungen!

Rohrabschlussstopfen, flach
Embout de fermeture, Plat
End cap, Flat

≥ 0,89
€/Stk./pcs.



V2A / INOX 304

øD x s /mm	Best.-Nr.	€/ Stk / pcs.	
		≤ 99	≥ 100
12,0 x 1,0	1009-1210	0,99	0,89
12,0 x 1,5	1009-1215	0,99	0,89
12,0 x 2,0	1009-1220	0,99	0,89
16,0 x 1,0	1009-1610	1,19	1,09
16,0 x 1,5	1009-1615	1,19	1,09
20,0 x 1,0	1009-2010	1,39	1,29
20,0 x 1,5	1009-2015	1,39	1,29
21,3 x 2,0	1009-2120	1,39	1,29
22,0 x 1,0	1009-2210	1,49	1,39
22,0 x 1,5	1009-2215	1,49	1,39
25,0 x 1,5	1009-2515	1,79	1,69
25,0 x 2,0	1009-2520	1,79	1,69
26,9 x 2,0	1004	1,89	1,79
33,7 x 1,5	1009-3315	1,99	1,89
33,7 x 2,0	1001	1,99	1,79
33,7 x 2,6	1005	1,99	1,89
40,2 x 1,5	1009-4015	1,99	1,89
40,2 x 2,0	1009-4020	1,99	1,89
42,4 x 1,5	1009-4215	1,99	1,89
42,4 x 2,0	1002	1,99	1,79
42,4 x 2,6	1006	1,99	1,89
48,3 x 2,0	1003	2,59	2,29
48,3 x 2,6	1007	2,99	2,79
60,3 x 2,0	1008	3,99	3,89
76,1 x 1,5	1009-7615	5,49	5,19
76,1 x 2,0	1009-7620	5,79	5,49
88,9 x 1,5	1009-8815	6,59	6,29
88,9 x 2,0	1009-8820	6,89	6,59
101,6 x 1,5	1009-1015	7,69	7,39
101,6 x 2,0	1009-1020	7,99	7,69

Disponible maintenant dans de nombreux formats



øD x s /mm	Best.-Nr.	€/ Stk / pcs.	
		≤ 99	≥ 100
12,0 x 1,0	1018-1210	0,99	0,89
12,0 x 1,5	1018-1215	0,99	0,89
12,0 x 2,0	1018-1220	0,99	0,89
16,0 x 1,0	1018-1610	1,19	1,09
16,0 x 1,5	1018-1615	1,19	1,09
20,0 x 1,0	1018-2010	1,39	1,29
20,0 x 1,5	1018-2015	1,39	1,29
21,3 x 2,0	1018-2120	1,39	1,29
22,0 x 1,0	1018-2210	1,49	1,39
22,0 x 1,5	1018-2215	1,49	1,39
25,0 x 1,5	1018-2515	1,79	1,69
25,0 x 2,0	1018-2520	1,79	1,69
26,9 x 2,0	1013	1,89	1,79
33,7 x 1,5	1018-3315	1,99	1,89
33,7 x 2,0	1010	1,99	1,79
33,7 x 2,6	1014	1,99	1,89
40,2 x 1,5	1018-4015	1,99	1,89
40,2 x 2,0	1018-4020	1,99	1,89
42,4 x 1,5	1018-4215	1,99	1,89
42,4 x 2,0	1011	1,99	1,79
42,4 x 2,6	1015	1,99	1,89
48,3 x 2,0	1012	2,59	2,29
48,3 x 2,6	1016	2,99	2,79
60,3 x 2,0	1017	3,99	3,89
76,1 x 1,5	1018-7615	5,49	5,19
76,1 x 2,0	1018-7620	5,79	5,49
88,9 x 1,5	1018-8815	6,59	6,29
88,9 x 2,0	1018-8820	6,89	6,59
101,6 x 1,5	1018-1015	7,69	7,39
101,6 x 2,0	1018-1020	7,99	7,69

With new measurements





Rohrabschlussstopfen, gewölbt mit M8 Gewinde
 Embout de fermeture, Bombé avec filetage M8
 End cap, Cambered with M8-thread

≥ **2,69**
 €/Stk./pcs.



Rohrabschlussstopfen, flach mit M8 Gewinde
 Embout de fermeture, Plat, filetage M8
 End cap, Flat, with M8-thread

≥ **2,69**
 €/Stk./pcs.



øD x s /mm	Best.-Nr.	€/ Stk / pcs.	
		≤ 99	≥ 100
26,9 x 2,0	1004-G	2,89	2,79
33,7 x 1,5	1009-3315-G	2,99	2,79
33,7 x 2,0	1001-G	2,89	2,69
33,7 x 2,6	1005-G	2,99	2,89
40,2 x 1,5	1009-4015-G	2,99	2,89
40,2 x 2,0	1009-4020-G	2,99	2,89
42,4 x 2,0	1002-G	2,99	2,79
42,4 x 2,6	1006-G	3,09	2,99
48,3 x 2,0	1003-G	3,89	3,69
48,3 x 2,6	1007-G	3,99	3,89
60,3 x 2,0	1008-G	4,99	4,89
76,1 x 1,5	1009-7615-G	6,49	6,39
76,1 x 2,0	1009-7620-G	6,79	6,69
88,9 x 1,5	1009-8815-G	7,59	7,49
88,9 x 2,0	1009-8820-G	7,89	7,69
101,6 x 1,5	1009-1015-G	8,69	8,49
101,6 x 2,0	1009-1020-G	8,99	8,79

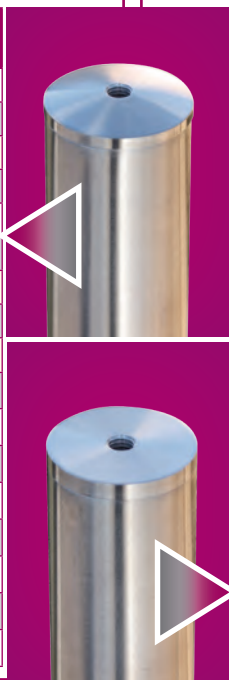

øD x s /mm	Best.-Nr.	€/ Stk / pcs.	
		≤ 99	≥ 100
26,9 x 2,0	1013-G	2,89	2,79
33,7 x 1,5	1018-3315-G	2,99	2,79
33,7 x 2,0	1010-G	2,89	2,69
33,7 x 2,6	1014-G	2,99	2,89
40,2 x 1,5	1018-4015-G	2,99	2,89
40,2 x 2,0	1018-4020-G	2,99	2,89
42,4 x 2,0	1011-G	2,99	2,79
42,4 x 2,6	1015-G	3,09	2,99
48,3 x 2,0	1012-G	3,89	3,69
48,3 x 2,6	1016-G	3,99	3,89
60,3 x 2,0	1017-G	4,99	4,89
76,1 x 1,5	1018-7615-G	6,49	6,39
76,1 x 2,0	1018-7620-G	6,79	6,69
88,9 x 1,5	1018-8815-G	7,59	7,49
88,9 x 2,0	1018-8820-G	7,89	7,69
101,6 x 1,5	1018-1015-G	8,69	8,49
101,6 x 2,0	1018-1020-G	8,99	8,79



gewölbt mit 8 mm Bohrung

≥ **2,09**
 €/Stk./pcs.

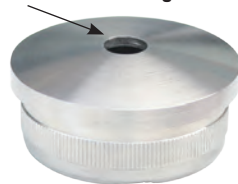

Rohrabschlussstopfen, gewölbt mit 8 mm Bohrung
 Embout de fermeture, Bombé avec trou de 8 mm
 End cap, Cambered with 8 mm hole

øD x s	Best.-Nr.	€/ Stk / pcs.	
33,7 x 2,0	1001-B	2,29	2,09
42,4 x 2,0	1002-B	2,29	2,09
42,4 x 2,6	1006-B	2,29	2,09

Rohr-Kugelstopfen
 Embout hémisphérique
 Hemisphere end cap



≥ **2,49**
 €/Stk./pcs.



Rohr-Kugelstopfen, mit M8 Gewinde
 Embout hémisphérique, Filetage M8
 Hemisphere end cap, With M8-thread



≥ **3,19**
 €/Stk./pcs.

øD x s /mm	Best.-Nr.	€/ Stk / pcs.	
		≤ 99	≥ 100
26,9 x 2,0	1023	2,69	2,49
33,7 x 2,0	1020	2,69	2,49
33,7 x 2,6	1024	2,69	2,49
42,4 x 2,0	1021	2,69	2,49
42,4 x 2,6	1025	2,69	2,49
48,3 x 2,0	1022	3,59	3,29
48,3 x 2,6	1026	3,59	3,29

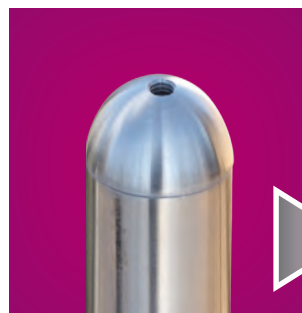

øD x s /mm	Best.-Nr.	€/ Stk / pcs.	
		≤ 99	≥ 100
26,9 x 2,0	1023-G	3,39	3,19
33,7 x 2,0	1020-G	3,39	3,19
33,7 x 2,6	1024-G	3,39	3,19
42,4 x 2,0	1021-G	3,39	3,19
42,4 x 2,6	1025-G	3,39	3,19
48,3 x 2,0	1022-G	4,39	3,99
48,3 x 2,6	1026-G	4,39	3,99

E-mail: info@akbas-schmiedeeisen.de, www.akbas-schmiedeeisen.de

Tel: +49(0) 61 44 33 05-0, Fax: +49(0) 61 44 33 05-15

Tel: +33.3.68680131, E-mail: vente@akbas-schmiedeeisen.de, Tel: +44.151.6018946, E-mail: sales@akbas-schmiedeeisen.de

V2A / INOX 304

AK INOX

Rohrabschluss / Embout de fermeture / End cap

Rohr-Knopf
Pommeaux
Knobs

≥ 9,99
€/Stk./pcs.



øD x s /mm	Best.-Nr.	€/ Stk / pcs.
33,7 x 2,0	1036	9,99
33,7 x 2,6	1037	10,29
42,4 x 2,0	1038	13,49
42,4 x 2,6	1039	13,59
48,3 x 2,0	1040	15,29
48,3 x 2,6	1041	15,39



Rohr-Knopf
Pommeaux
Knobs

≥ 9,99
€/Stk./pcs.



øD x s /mm	Best.-Nr.	€/ Stk / pcs.
33,7 x 2,0	1030	9,99
33,7 x 2,6	1033	10,29
42,4 x 2,0	1031	13,49
42,4 x 2,6	1034	13,59
48,3 x 2,0	1032	15,29
48,3 x 2,6	1035	15,39



Rohr-Knopf
Pommeaux
Knobs

≥ 8,99
€/Stk./pcs.



øD x s /mm	H	Best.-Nr.	€/ Stk / pcs.
32,0 x 1,5	42	1042-32E	8,99
33,7 x 2,0	42	1042-33	10,99
38,0 x 1,5	53	1042-38E	9,49
42,4 x 1,5	53	1042-42E	9,99
42,4 x 2,0	53	1042-42	11,99

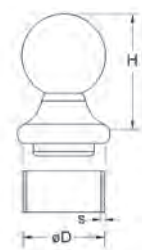

Rohr-Abschlusskugeln
Embout sphérique
Sphere end cap

≥ 4,39
€/Stk./pcs.

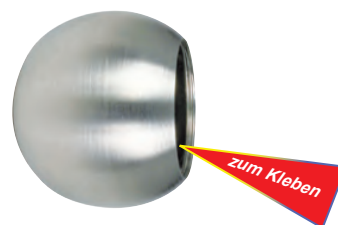

øB /mm	øD /mm	Best.-Nr.	€/ Stk / p cs.
26,9	40	1050	4,39
33,7	45	1051	5,29
42,4	55	1052	6,29
48,3	60	1053	8,49



V2A / INOX 304

AK INOX

≥ 2,39
€/Stk./pcs.

Zierteile / Accessoires / Accessories

ø 24 x 50 mm zum Kleben *

øB /mm	Best.-Nr.	€/ Stk / pcs. ≤ 49	≥ 50
10,2	1980-10	3,49	3,29
12,2	1980-12	3,49	3,29
14,2	1980-14	3,49	3,29

ø 24 x 40 mm zum Kleben *

øB /mm	Best.-Nr.	€/ Stk / pcs. ≤ 49	≥ 50
10,2	1981-10	2,99	2,79
12,2	1981-12	2,99	2,79
14,2	1981-14	2,99	2,79

ø 24 x 18 mm zum Kleben *

øB /mm	Best.-Nr.	€/ Stk / pcs. ≤ 49	≥ 50
10,2	1982-10	2,59	2,39
12,2	1982-12	2,59	2,39
14,2	1982-14	2,59	2,39

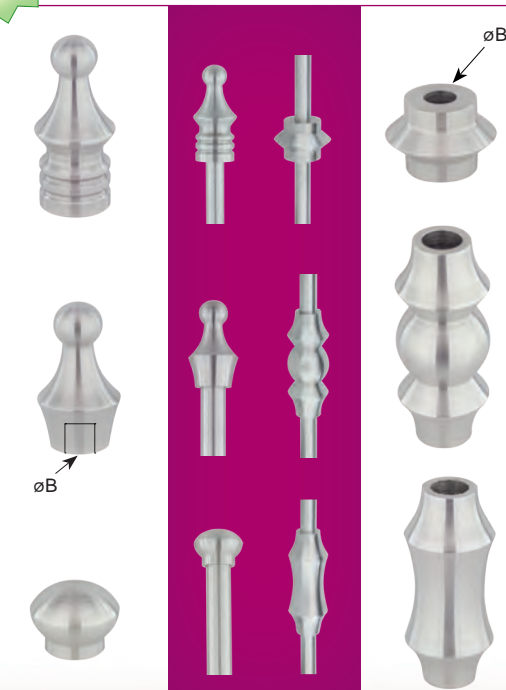

ø 35 x 24 mm zum Kleben *

øB /mm	Best.-Nr.	€/ Stk / pcs. ≤ 49	≥ 50
10,2	1983-10	3,59	3,39
12,2	1983-12	3,59	3,39
14,2	1983-14	3,59	3,39

ø 30 x 70 mm mit Klemmschraube **

øB /mm	Best.-Nr.	€/ Stk / pcs. ≤ 49	≥ 50
10,2	1984-10	6,49	5,99
12,2	1984-12	5,49	4,99
14,2	1984-14	6,49	5,99

ø 30 x 70 mm mit Klemmschraube **

øB /mm	Best.-Nr.	€/ Stk / pcs. ≤ 49	≥ 50
10,2	1985-10	6,49	5,99
12,2	1985-12	5,49	4,99
14,2	1985-14	6,49	5,99

Hohlkugeln
Sphères / Spheres



≥
1,79
€/Stk./pcs.

Material ≥ 2 mm

øD /mm	Best.-Nr.	€/ Stk / pcs.	
		≤ 49	≥ 50
20 massiv	1600	1,99	1,79
25 massiv	1601	2,29	2,09
30 massiv	1602	2,99	2,69
40	1603	3,79	3,29
50	1604	4,89	4,29
60	1605	6,49	5,99
70	1606	7,99	7,49
80	1607	8,99	8,49
90	1608	13,99	13,49
100	1609	14,99	13,99
120	1610	18,99	17,99
150	1611	46,99	44,99
200	1612	89,99	84,99

Hohlkugeln, mit Gewinde / Sphères, avec pas de vis
Spheres, with screw hole



≥
1,49
€/Stk./pcs.

Material ≥ 2 mm

øD /mm	M	Best.-Nr.	€/ Stk / pcs.	
			≤ 49	≥ 50
20	M6	1600-G	1,79	1,49
25	M6	1601-G	2,49	1,99
30	M6	1602-G	3,29	2,99
40	M8	1603-G	3,79	3,49
50	M8	1604-G	5,99	5,49
60	M8	1605-G	6,99	6,49
70	M8	1606-G	8,99	8,49
80	M10	1607-G	9,79	9,29
90	M10	1608-G	13,99	12,99
100	M10	1609-G	15,49	14,49
120	M10	1610-G	19,99	18,99
150	M12	1611-G	49,99	47,99
200	M12	1612-G	99,99	94,99

Halbhohlkugeln
Demi-sphère / Hemisphere



≥
0,94
€/Stk./pcs.

Material ≥ 2 mm

øD /mm	Best.-Nr.	Stk / pcs.
20	1640	0,94
26,9	1641	1,09
30	1642	1,59
33,7	1653	1,69
40	1643	1,89
42,4	1654	1,99
48,3	1655	2,29
50	1644	2,59
60	1645	3,49
70	1646	4,19
80	1647	4,49
90	1648	5,79
100	1649	7,69
120	1650	9,99
150	1651	23,49
200	1652	44,99

Kugel mit Sackloch
Embout sphérique / Sphere end cap



≥
1,69
€/Stk./pcs.

øD /mm	øB /mm	Best.-Nr.	€/ Stk / pcs.	
			≤ 49	≥ 50
20	10,2	1600-10	1,89	1,69
25	10,2	1601-10	1,99	1,79
20	12,2	1600-12	1,89	1,69
25	12,2	1601-12	1,99	1,79
30	12,2	1602-12	2,89	2,59

Kugel mit Durchgangsbohrung 12,5 mm
Sphère pleine troué taille - à calibre 12,5 mm
Solid ball with 12,5 mm hole

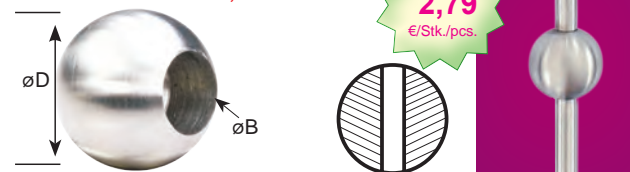

≥
2,79
€/Stk./pcs.

øD /mm	øB /mm	Best.-Nr.	€/ Stk / pcs.	
			≤ 49	≥ 50
30	12,2	1602-12D	2,99	2,79
40	12,2	1603-12D	3,49	3,19

V2A / INOX 304

AK INOX

Querstabhalter mit Rundanschluss Support transversal percé, terminaison concave / Bar holder with concave back

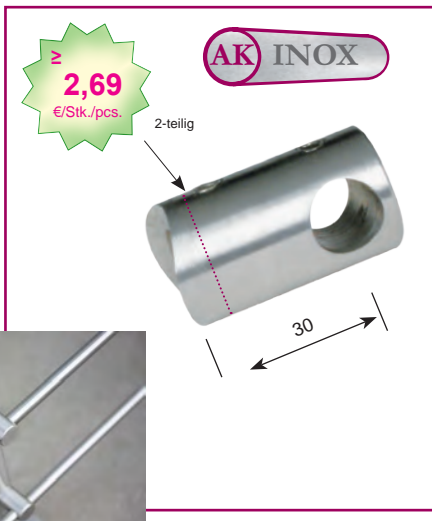
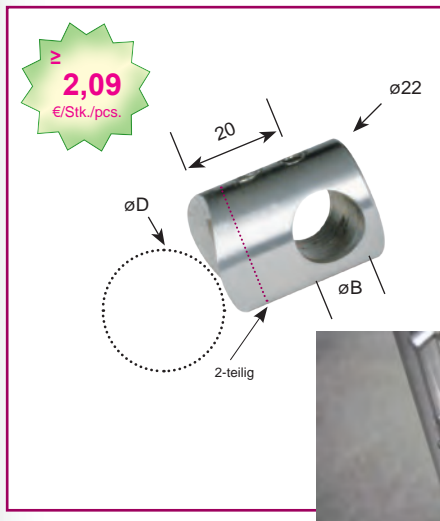

øD /mm	øB /mm	Best.-Nr.	€ / Stk / pcs.	
			≤ 99	≥ 100
33,7	10,2	1970-3310	2,49	2,19
33,7	12,2	1970-3312	2,49	2,19
42,4	10,2	1970-4210	2,49	2,19
42,4	12,2	1970-4212	2,39	2,09
48,3	10,2	1970-4810	2,49	2,19
48,3	12,2	1970-4812	2,49	2,19

øD /mm	øB /mm	Best.-Nr.	€ / Stk / pcs.	
			≤ 99	≥ 100
33,7	10,2	1971-3310	2,99	2,69
33,7	12,2	1971-3312	2,99	2,69
42,4	10,2	1971-4210	2,99	2,69
42,4	12,2	1971-4212	2,99	2,69
48,3	10,2	1971-4810	2,99	2,69
48,3	12,2	1971-4812	2,99	2,69

øD /mm	øB /mm	Best.-Nr.	€ / Stk / pcs.	
			≤ 99	≥ 100
33,7	10,2	1972-3310	4,29	3,99
33,7	12,2	1972-3312	4,29	3,99
42,4	10,2	1972-4210	4,29	3,99
42,4	12,2	1972-4212	4,29	3,99
48,3	10,2	1972-4810	4,29	3,99
48,3	12,2	1972-4812	4,29	3,99

Querstabhalter mit Rundanschluss und Sackloch Support transversal percé, trou borgne / End post bar holder with concave back



øD /mm	øB /mm	Best.-Nr.	€ / Stk / pcs.	
			≤ 99	≥ 100
33,7	10,2	1973-3310-R	2,49	2,19
33,7	10,2	1973-3310-L	2,49	2,19
33,7	12,2	1973-3312-R	2,49	2,19
33,7	12,2	1973-3312-L	2,49	2,19
42,4	10,2	1973-4210-R	2,49	2,19
42,4	10,2	1973-4210-L	2,49	2,19
42,4	12,2	1973-4212-R	2,49	2,19
42,4	12,2	1973-4212-L	2,49	2,19
48,3	10,2	1973-4810-R	2,49	2,19
48,3	10,2	1973-4810-L	2,49	2,19
48,3	12,2	1973-4812-R	2,49	2,19
48,3	12,2	1973-4812-L	2,49	2,19

øD /mm	øB /mm	Best.-Nr.	€ / Stk / pcs.	
			≤ 99	≥ 100
33,7	10,2	1974-3310-R	3,49	3,19
33,7	10,2	1974-3310-L	3,49	3,19
33,7	12,2	1974-3312-R	3,49	3,19
33,7	12,2	1974-3312-L	3,49	3,19
42,4	10,2	1974-4210-R	3,49	3,19
42,4	10,2	1974-4210-L	3,49	3,19
42,4	12,2	1974-4212-R	3,49	3,19
42,4	12,2	1974-4212-L	3,49	3,19
48,3	10,2	1974-4810-R	3,49	3,19
48,3	10,2	1974-4810-L	3,49	3,19
48,3	12,2	1974-4812-R	3,49	3,19
48,3	12,2	1974-4812-L	3,49	3,19

øD /mm	øB /mm	Best.-Nr.	€ / Stk / pcs.	
			≤ 99	≥ 100
33,7	10,2	1975-3310-R	4,29	3,99
33,7	10,2	1975-3310-L	4,29	3,99
33,7	12,2	1975-3312-R	4,29	3,99
33,7	12,2	1975-3312-L	4,29	3,99
42,4	10,2	1975-4210-R	4,29	3,99
42,4	10,2	1975-4210-L	4,29	3,99
42,4	12,2	1975-4212-R	4,29	3,99
42,4	12,2	1975-4212-L	4,29	3,99
48,3	10,2	1975-4810-R	4,29	3,99
48,3	10,2	1975-4810-L	4,29	3,99
48,3	12,2	1975-4812-R	4,29	3,99
48,3	12,2	1975-4812-L	4,29	3,99

V2A / INOX 304

AK INOX

Querstabhalter mit Flachanschluss Support transversal percé, terminaison concave / Bar holder with concave back

≥ 2,09
€/Stk./pcs.

øB /mm	Best.-Nr.	€/ Stk / pcs.	≤ 99	≥ 100
10,2	1970-10	2,49	2,19	
12,2	1970-12	2,39	2,09	

≥ 2,69
€/Stk./pcs.

øB /mm	Best.-Nr.	€/ Stk / pcs.	≤ 99	≥ 100
10,2	1971-10	2,99	2,69	
12,2	1971-12	2,99	2,69	

≥ 3,99
€/Stk./pcs.

øB /mm	Best.-Nr.	€/ Stk / pcs.	≤ 99	≥ 100
10,2	1972-10	4,29	3,99	
12,2	1972-12	4,29	3,99	

Querstabhalter mit Flachanschluss und Sackloch Support transversal percé, trou borgne, terminaison droite / End post bar holder with flat back

≥ 2,19
€/Stk./pcs.

øB /mm	Best.-Nr.	€/ Stk / pcs.	≤ 99	≥ 100
10,2	1973-10-R	2,49	2,19	
10,2	1973-10-L	2,49	2,19	
12,2	1973-12-R	2,49	2,19	
12,2	1973-12-L	2,49	2,19	

≥ 3,19
€/Stk./pcs.

øB /mm	Best.-Nr.	€/ Stk / pcs.	≤ 99	≥ 100
10,2	1974-10-R	3,49	3,19	
10,2	1974-10-L	3,49	3,19	
12,2	1974-12-R	3,49	3,19	
12,2	1974-12-L	3,49	3,19	

≥ 3,99
€/Stk./pcs.

øB /mm	Best.-Nr.	€/ Stk / pcs.	≤ 99	≥ 100
10,2	1975-10-R	4,29	3,99	
10,2	1975-10-L	4,29	3,99	
12,2	1975-12-R	4,29	3,99	
12,2	1975-12-L	4,29	3,99	

≥ 1,99
€/Stk./pcs.

øD /mm	øB /mm	Best.-Nr.	€/ Stk / pcs.	≤ 99	≥ 100
42,4	10,2	1970-4210 D	2,29	1,99	
42,4	12,2	1970-4212 D	2,29	1,99	

≥ 1,79
€/Stk./pcs.

øD /mm	øB /mm	Best.-Nr.	€/ Stk / pcs.	≤ 99	≥ 100
33,7	10,2	1970-3310 E	1,99	1,79	
33,7	12,2	1970-3312 E	1,99	1,79	
42,4	10,2	1970-4210 E	1,99	1,79	
42,4	12,2	1970-4212 E	1,99	1,79	

Querstabhalter mit Doppelbohrung Support transversal percé, deux trous Bar holder with double hole

≥ 3,99
€/Stk./pcs.

øB /mm	Best.-Nr.	€/ Stk / pcs.	≤ 99	≥ 100
10,2 - 12,2	1976-1012	4,29	3,99	
12,2 - 12,2	1976-1212	4,29	3,99	

Distanz-Querstabhalter für 2 Flachmaterial Distance-Support transversal percé, deux trous Distance-Bar holder for two flat material

≥ 4,49
€/Stk./pcs.

**Nouveau - New
Neu**

øB /mm	Best.-Nr.	€/ Stk / pcs.	≤ 99	≥ 100
12,2	1978-12	4,99	4,49	

E-mail: info@akbas-schmiedeeisen.de, www.akbas-schmiedeeisen.de

Tel: +49(0) 61 44 33 05-0, Fax: +49(0) 61 44 33 05-15

Tel: +33.3.68680131, E-mail: vente@akbas-schmiedeeisen.de, Tel: +44.151.6018946, E-mail: sales@akbas-schmiedeeisen.de

AK INOX

Handlaufzubehör Accessoires de main-courantes / Handrail accessories

Handlaufhalter mit 2 Bohrungen
Support main courante avec 2 trous
Handrail bracket with 2 holes

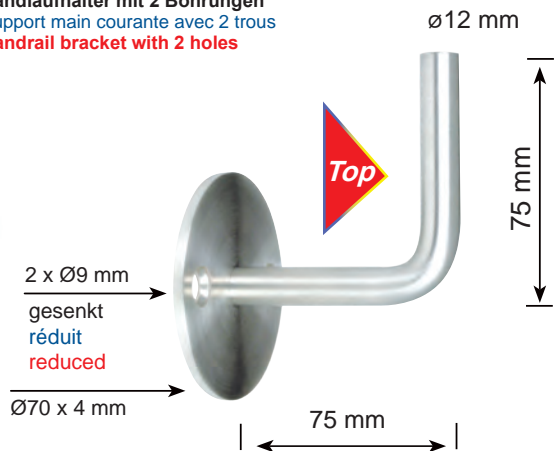

Best.-Nr.	€/ Stk / pcs.	
	≤ 99	≥ 100
1220	4,49	3,99

Handlaufhalter mit 3 Bohrungen
Support main courante avec 3 trous
Handrail bracket with 2 holes

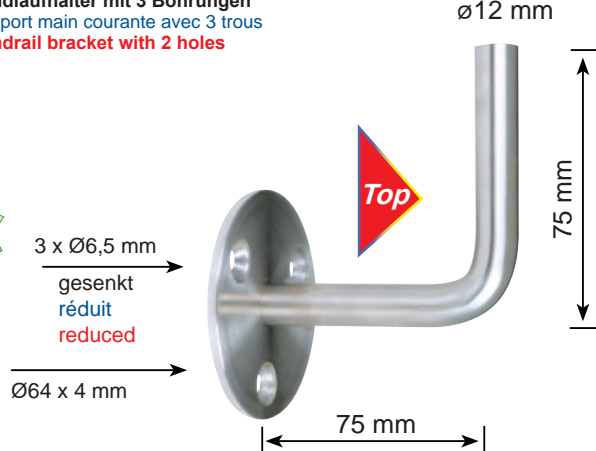

Best.-Nr.	€/ Stk / pcs.	
	≤ 99	≥ 100
1240	4,49	3,99

V2A Handlaufhalter für M8 Stockschraube
Support main courante pour vis doubles filets M8
Handrail bracket for M8 hanger bolt

Auslieferung ohne Befestigungsschrauben
Livraison sans vis de fixation
Delivery without mounting screws

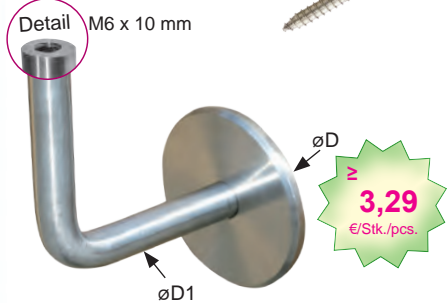

øD /mm	øD1 /mm	Best.-Nr.	€/ Stk / pcs.	
			≤ 99	≥ 100
60x4	12	1248-2	3,79	3,29

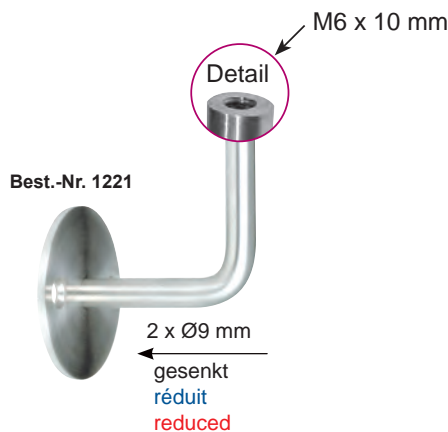

Best.-Nr.	€/ Stk / pcs.	
	≤ 99	≥ 100
1221	4,99	4,49
1222	4,99	4,49



≥ 4,49 €/Stk./pcs.

V2A Handlaufhalter für M8 Stockschraube
Support main courante pour vis doubles filets M8
Handrail bracket for M8 hanger bolt

Auslieferung ohne Befestigungsschrauben
Livraison sans vis de fixation
Delivery without mounting screws

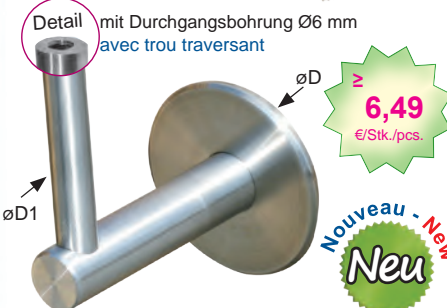

øD /mm	øD1 /mm	Best.-Nr.	€/ Stk / pcs.	
			≤ 99	≥ 100
60x4	12	1248-1	6,99	6,49



Best.-Nr.	€/ Stk / pcs.	
	≤ 99	≥ 100
1241	4,99	4,49
1242	4,99	4,49



≥ 4,49 €/Stk./pcs.

V2A / INOX 304

Handlaufträger mit Abschlusskugel
Support de main courante avec anneau borgne
Handrail bracket with blind sphere ring



øD /mm	Best.-Nr.	€ / Stk / pcs.	
		≤ 9	≥ 10
33,7	1250	9,99	9,69
42,4	1251	10,99	10,69

≥ **9,69**
€/Stk./pcs.

Handlaufträger mit Kugelring
Support de main courante avec anneau
Handrail bracket with sphere ring

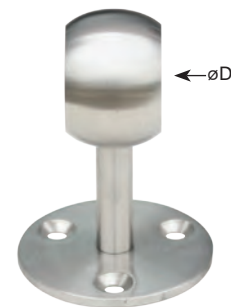

øD /mm	Best.-Nr.	€ / Stk / pcs.	
		≤ 9	≥ 10
33,7	1252	9,99	9,69
42,4	1253	10,99	10,69

≥ **9,69**
€/Stk./pcs.

Handlaufträger mit Abschlusskugel
Support de main courante avec anneau borgne
Handrail bracket with blind sphere ring



øD /mm	Best.-Nr.	€ / Stk / pcs.	
		≤ 9	≥ 10
33,7	1243	10,99	10,49
42,4	1244	11,99	11,49

≥ **10,49**
€/Stk./pcs.

Handlaufträger mit Kugelring
Support de main courante avec anneau
Handrail bracket with sphere ring



øD /mm	Best.-Nr.	€ / Stk / pcs.	
		≤ 9	≥ 10
33,7	1245	10,99	10,49
42,4	1246	11,99	11,49

≥ **10,49**
€/Stk./pcs.

Kugel-Ring
Anneau sphérique
Sphere ring

≥ **3,89**
€/Stk./pcs.

øB /mm	øD /mm	Best.-Nr.	€ / Stk / pcs.	
			≤ 9	≥ 10
26,9	40	1054	4,19	3,89
33,7	45	1055	5,49	4,99
42,4	55	1056	6,99	6,49
48,3	60	1057	8,29	7,99

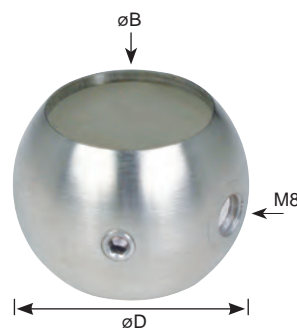



≥ **2,69** €/Stk./pcs.

øD /mm	øD1 /mm	Best.-Nr.	€ / Stk / pcs.	≤ 99	≥ 100
60	10	1247-10	2,99	2,69	
70	12	1247-12	3,29	2,99	



M6 x 10 mm Detail

≥ **2,99** €/Stk./pcs.

øD /mm	øD1 /mm	Best.-Nr.	€ / Stk / pcs.	≤ 99	≥ 100
60	10	1247-10-G	3,29	2,99	
70	12	1247-12-G	3,59	3,29	



≥ **3,99** €/Stk./pcs.

øD

65

ø25 mm mit Durchgangsbohrungen avec trou traversant

kombinierbar z.B. mit 1002-B oder 1002-G

øD /mm	Best.-Nr.	€ / Stk / pcs.	≤ 49	≥ 50
33,7	1268-33	4,49	3,99	
42,4	1268-42	4,49	3,99	
48,3	1268-48	4,49	3,99	



≥ **3,79** €/Stk./pcs.

øD

65

M8

ø25 mm

kombinierbar z.B. mit 1002-B

Nouveau - New Neu

øD /mm	Best.-Nr.	€ / Stk / pcs.	≤ 49	≥ 50
33,7	1267-33	3,99	3,79	
42,4	1267-42	3,99	3,79	
48,3	1267-48	3,99	3,79	

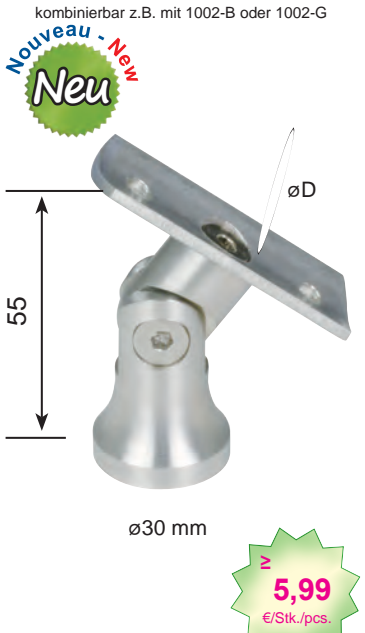

kombinierbar z.B. mit 1002-B oder 1002-G

Nouveau - New Neu

55

ø30 mm

≥ **5,99** €/Stk./pcs.

øD /mm	Best.-Nr.	€ / Stk / pcs.	≤ 49	≥ 50
33,7	1266-33	6,99	5,99	
42,4	1266-42	6,99	5,99	
48,3	1266-48	6,99	5,99	



≥ **6,49** €/Stk./pcs.

“ecoline”

ø51

90°

90°

s

øD

øDxs /mm	H /mm	Best.-Nr.	€ / Stk / pcs.
33,7 x 2,0	24	1269-33	6,49
42,4 x 2,0	25	1269-42	6,99



≥ **5,99** €/Stk./pcs.

“ecoline”

øB

H

90°

s

øD

øDxs /mm	H /mm	Best.-Nr.	€ / Stk / pcs.
33,7 x 2,0	21	1270-33	5,99
42,4 x 2,0	22	1270-42	6,49

øD /mm	A /mm	Best.-Nr.	€/ Stk / pcs. ≤ 99	≥ 100
33,7	65	1289-33	1,59	1,49
42,4	65	1289-42	1,59	1,49
48,3	65	1289-48	1,59	1,49

øD /mm	L /mm	Best.-Nr. Code	€/ Stk / pcs. ≤ 99	≥ 100
33,7	65	1280	1,39	1,29
42,4	65	1281	1,39	1,29
48,3	65	1282	1,39	1,29
33,7	80	1283	1,39	1,29
42,4	80	1284	1,39	1,29
48,3	80	1285	1,39	1,29

für Vierkantrohr
pour tube carré
Rectangle tube

L x W x s /mm	Best.-Nr.	€/ Stk / pcs. ≤ 99	≥ 100
65x25x3	1279-65	1,39	1,29

Best.-Nr.	€/ Stk / pcs. ≤ 99	≥ 100
1225	1,99	1,69
1226	2,19	1,89
1228	2,19	1,89
1229	2,99	2,69
1229-G	3,49	3,19

L /mm	Best.-Nr.	€/ Stk / pcs. ≤ 99	≥ 100
65	1290	1,59	1,39
100	1291	1,69	1,49
120	1296	1,79	1,69

L /mm	Best.-Nr.	€/ Stk / pcs. ≤ 99	≥ 100
65	1292	1,89	1,69
100	1293	1,99	1,79
120	1297	2,19	1,99

L x L1 x øD /mm	Best.-Nr.	€/ Stk / pcs. ≤ 99	≥ 100
100x50x12	1247-150	1,99	1,79

AK INOX

Abdeckkrosetten / Rosaces / Cover plates

≥ **1,59**
€/Stk./pcs.



ø 50 x 8 mm

øB /mm	Best.-Nr.	€/ Stk / pcs.	
		≤ 49	≥ 50
10,5	1207-10	1,79	1,59
12,5	1207-12	1,79	1,59
14,5	1207-14	1,79	1,59

≥ **1,89**
€/Stk./pcs.



E= "ecoline"

ø 68 x 12 mm

øB /mm	Best.-Nr.	€/ Stk / pcs.	
		≤ 49	≥ 50
12,5	1205-12 E	1,99	1,89
12,5	1205-12	1,99	1,89
34,0	1205-34	1,99	1,89

≥ **1,89**
€/Stk./pcs.



ø 75 x 12 mm

øB /mm	Best.-Nr.	€/ Stk / pcs.	
		≤ 49	≥ 50
12,5	1206-12	1,99	1,89
14,5	1206-14	1,99	1,89
34,0	1206-34	1,99	1,89
43,0	1206-43	1,99	1,89
49,0	1206-49	1,99	1,89

≥ **2,49**
€/Stk./pcs.



ø 85 x 12 mm

øB /mm	Best.-Nr.	€/ Stk / pcs.	
		≤ 49	≥ 50
12,5	1218-12	2,79	2,49
14,5	1218-14	2,79	2,49
34,0	1218-34	2,79	2,49

≥ **2,59**
€/Stk./pcs.



ø 75 x 22 mm

øB /mm	Best.-Nr.	€/ Stk / pcs.	
		≤ 49	≥ 50
12,5	1210-12	2,89	2,59
14,5	1210-14	2,89	2,59
34,0	1210-34	2,89	2,59

≥ **3,39**
€/Stk./pcs.



ø 85 x 22 mm

øB /mm	Best.-Nr.	€/ Stk / pcs.	
		≤ 49	≥ 50
12,5	1219-12	3,69	3,39
14,5	1219-14	3,69	3,39
34,0	1219-34	3,69	3,39

≥ **3,69**
€/Stk./pcs.



ø 105 x 22 mm

øB /mm	Best.-Nr.	€/ Stk / pcs.	
		≤ 49	≥ 50
34,0	1216-34	3,99	3,69
43,0	1216-43	3,99	3,69
49,0	1216-49	3,99	3,69

≥ **4,19**
€/Stk./pcs.



ø 125 x 22 mm

øB /mm	Best.-Nr.	€/ Stk / pcs.	
		≤ 49	≥ 50
43,0	1217-43	4,49	4,19
49,0	1217-49	4,49	4,19

≥ **3,49**
€/Stk./pcs.



ø 75 x 24 mm

øB /mm	Best.-Nr.	€/ Stk / pcs.	
		≤ 49	≥ 50
12,5	1201-12	3,69	3,49
14,5	1201-14	3,69	3,49
34,0	1201-34	3,69	3,49

≥ **3,69**
€/Stk./pcs.



ø 85 x 24 mm

øB /mm	Best.-Nr.	€/ Stk / pcs.	
		≤ 49	≥ 50
12,5	1202-12	3,89	3,69
14,5	1202-14	3,89	3,69
34,0	1202-34	3,89	3,69

≥ **4,29**
€/Stk./pcs.



ø 105 x 38 mm

øB /mm	Best.-Nr.	€/ Stk / pcs.	
		≤ 49	≥ 50
34,0	1203-34	4,49	4,29
43,0	1203-43	4,49	4,29
49,0	1203-49	4,49	4,29

≥ **4,99**
€/Stk./pcs.



ø 125 x 38 mm

øB /mm	Best.-Nr.	€/ Stk / pcs.	
		≤ 49	≥ 50
43,0	1204-43	5,29	4,99
49,0	1204-49	5,29	4,99

V2A / INOX 304

Jetzt auch GLAS der Extraklasse im Sortiment !

Lieferbar in allen Glasstärken und Abmessungen.

Verkauf nur ab Lager Bischofsheim. Lieferung auf Anfrage.

- Einscheiben-Sicherheitsglas (ESG)
- Verbund-Sicherheitsglas (VSG aus TVG oder ESG)

Kanten poliert.

z.B. ESG 8 mm nur ab 49 EUR / m2



Wir danken der Fa. Ebert Metalldesign

Kanten poliert.

- Einscheiben-Sicherheitsglas matt (ESG)
- Verbund-Sicherheitsglas mit Mattfolie (VSG aus TVG oder ESG)



Wir danken der Fa. AAE

V2A / INOX 304

E-mail: info@akbas-schmiedeeisen.de, www.akbas-schmiedeeisen.de

Tel: +49(0) 61 44 33 05-0, Fax: +49(0) 61 44 33 05-15

Tel: +33.3.68680131, E-mail: vente@akbas-schmiedeeisen.de Tel: +44.151.6018946, E-mail: sales@akbas-schmiedeeisen.de

AK-CG03



Best.-Nr. AK-CG03-S
 nur Zugstange
 seulement tige
 only rod

21,30
 €/Stk./pcs.

Nouveau - New
Neu

149,00
 €/Set

Lieferung ohne Glas

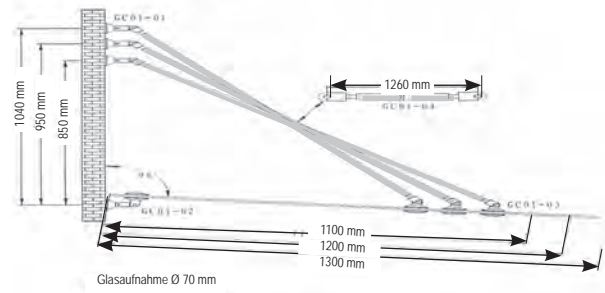

Angaben dienen nur zur Orientierung. Glasabmessungen und Anzahl der Konsolen müssen im Einzelfall bestimmt werden.

L'information est à titre indicatif seulement. Dimensions de verre et le nombre de supports doivent être déterminées dans chaque cas individuel.

Information is for guidance only. Glass dimensions and number of brackets must be determined in each individual case.

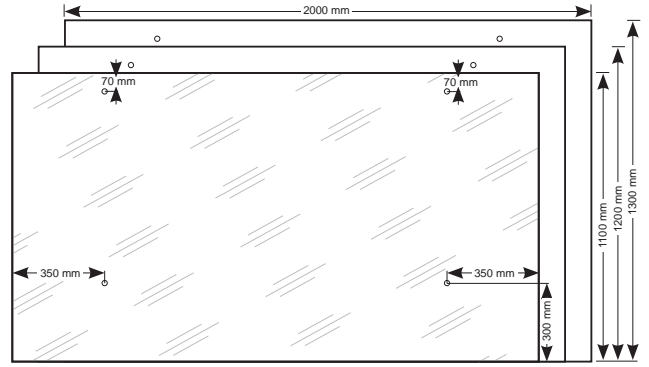

Bestehend aus	Best.-Nr.	€/Stk./pcs
1 x Wandhalter	AK-CG03-01	39,90
1 x Glashalter	AK-CG03-02	32,90
1 x Wandhalter für Glas	AK-CG03-03	67,90
1 x Zugstange	AK-CG03-S	21,30
		statt 162,00
Preis bezieht sich auf eine Achse !!		
Komplettes Set / Achse	AK-CG03	Le prix correspond à un axe !! 149,00 €



39,90
 €/Stk./pcs.



67,90
 €/Stk./pcs.



32,90
 €/Stk./pcs.

AK-CG01

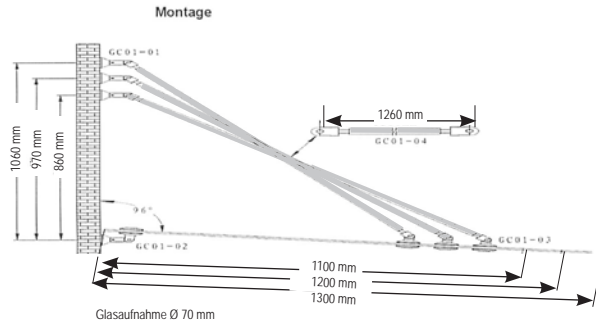

Angaben dienen nur zur Orientierung. Glasabmessungen und Anzahl der Konsolen müssen im Einzelfall bestimmt werden.

L'information est à titre indicatif seulement. Dimensions de verre et le nombre de supports doivent être déterminées dans chaque cas individuel.

Information is for guidance only. Glass dimensions and number of brackets must be determined in each individual case.

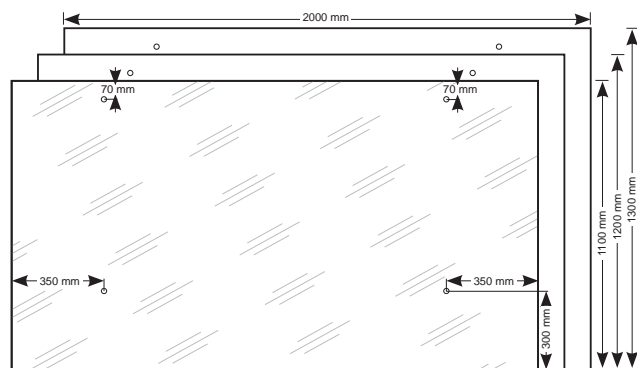

Bestehend aus	Best.-Nr.	€/Stk./pcs
1 x Wandhalter	AK-CG01-01	29,90
1 x Glashalter	AK-CG01-02	32,90
1 x Wandhalter für Glas	AK-CG01-03	57,90
1 x Zugstange	AK-CG01-S	21,30
		statt 142,00
Preis bezieht sich auf eine Achse !!		
Komplettes Set / Achse	AK-CG01	129,00 €

Price refers to an axis !!



AK-CG02

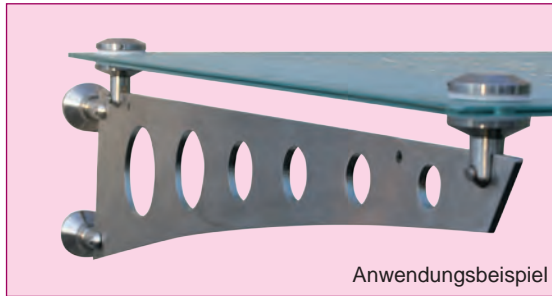

Nouveau - New
Neu

179,00
 €/Set

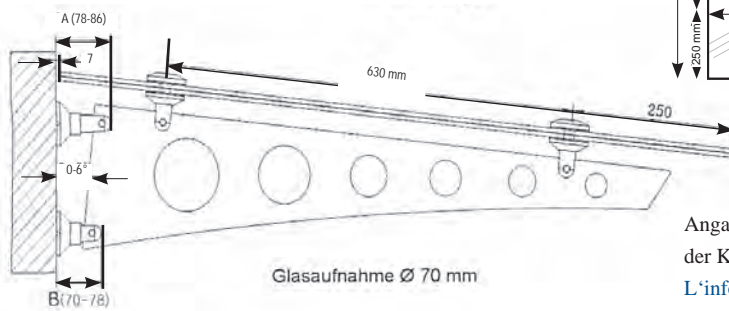
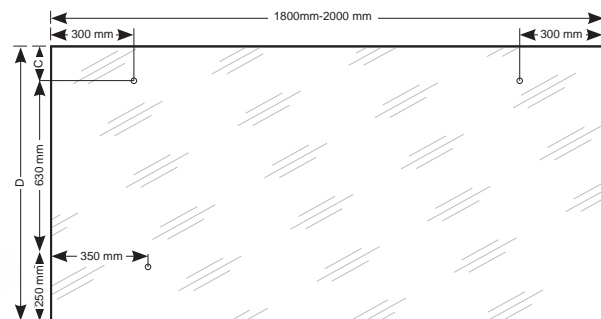
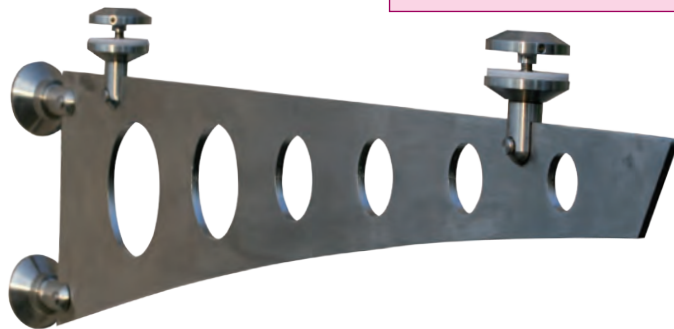

Angaben dienen nur zur Orientierung. Glasabmessungen und Anzahl der Konsolen müssen im Einzelfall bestimmt werden.

L'information est à titre indicatif seulement. Dimensions de verre et le nombre de supports doivent être déterminées dans chaque cas individuel.

Information is for guidance only. Glass dimensions and number of brackets must be determined in each individual case.

Bestehend aus	Best.-Nr.	€/Stk/pcs	€/2 Stk/pcs
2 x Wandhalter	AK-CG02-01	29,90	59,80
2 x Glashalter	AK-CG02-02	32,90	65,80
1 x Schwert	AK-CG02-S		72,40

statt 198,00

Preis bezieht sich auf eine Achse

Komplettes Set / Achse

AK-CG02

Le prix correspond à un axe !!

179,00 €



72,40
 €/Stk./pcs.

Best.-Nr. AK-CG02-S



29,90
 €/Stk./pcs.

Best.-Nr. AK-CG02-01



32,90
 €/Stk./pcs.

Best.-Nr. AK-CG02-02

INOX Form 10

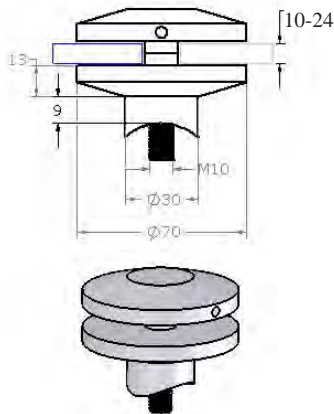

Nouveau - New
Neu

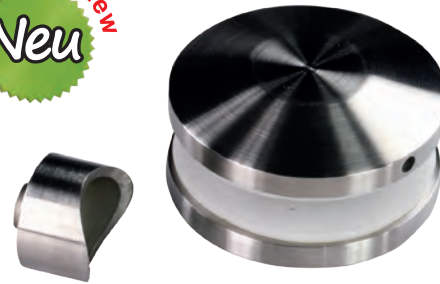

	R /mm	Best.-Nr.	€/ Stk / pcs.	
			≤ 49	≥ 50
V2A / Inox 304	00	1873-G	22,95	19,95
	42	1873-R42	22,95	19,95
	48	1873-R48	22,95	19,95
	60	1873-R60	22,95	19,95

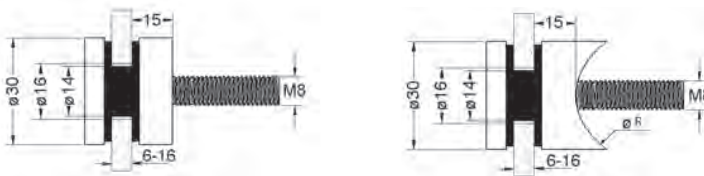

	R /mm	Best.-Nr.	€/ Stk / pcs.	
			≤ 99	≥ 100
V2A / Inox 304	00	1871-G	3,99	3,69
	32	1871-R32	3,99	3,69
	42	1871-R42	3,99	3,69
	48	1871-R48	3,99	3,69

≥ **3,69**
€/Stk./pcs.

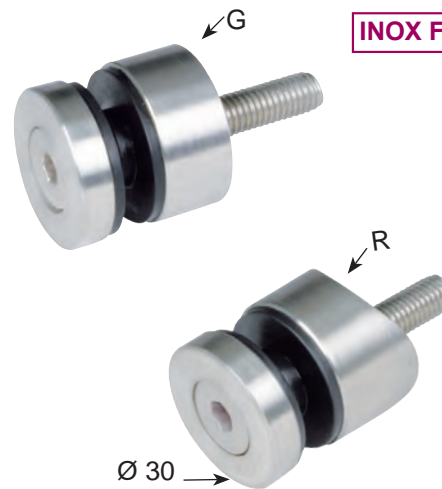

INOX Form 8

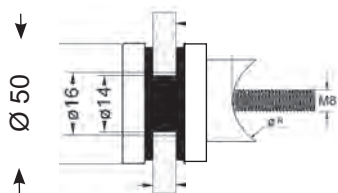

Für Flach (G) Profil plat Flat back	Für Rund (R) Profil incurvé Curved back	Für Glas Epaisseur de vitre Glass thickness
00	Ø, 42, 48 mm	6-16 mm

	R /mm	Best.-Nr.	€/ Stk / pcs.	
			≤ 99	≥ 100
V2A / Inox 304	00	1872-G	6,49	5,99
	42	1872-R42	6,49	5,99
	48	1872-R48	6,49	5,99

Nouveau - New
Neu

≥ **5,99**
€/Stk./pcs.

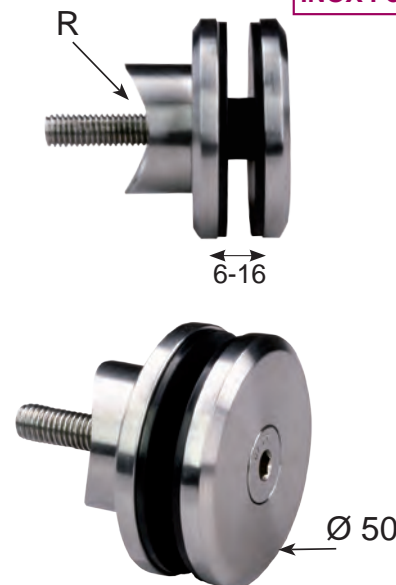

INOX Form 9

AK INOX

Klemmbefestigung Pince de vitre / Glass clamp

INOX Form 1

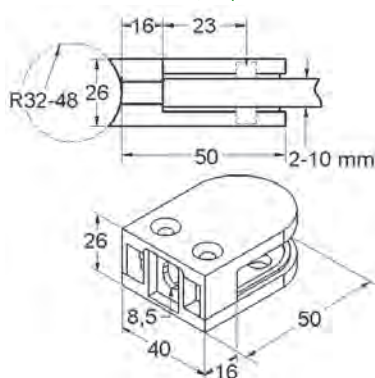

≥ 4,99
€/Stk./pcs.

Für Flach (G) Profil plat Flat back	Für Rund (R) Profil incurvé Curved back	Für Glas Epaisseur de vitre Glass thickness
00	ø 32, 42, 48 mm	2-10 mm

	R /mm	Best.-Nr.	€/ Stk / pcs.	
			≤ 99	≥ 100
V2A / Inox 304	00	1841-G	5,49	4,99
	32	1841-R32	5,49	4,99
	42	1841-R42	5,49	4,99
	48	1841-R48	5,49	4,99

Bitte vergessen Sie nicht, bei Ihrer Bestellung Glasstärke und Glasart (VSG oder ESG) anzugeben.
N'oubliez pas dire l'épaisseur et le type de vitre (sécurité ou laminé) dans vos commandes.
Don't forget to notify thickness and kind of glass (security or laminated) in your orders.

INOX Form 2

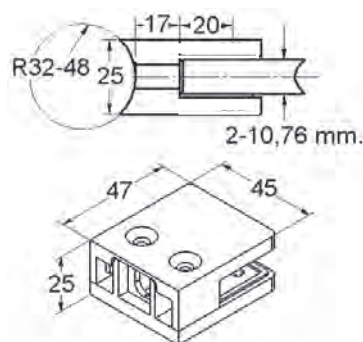

≥ 5,49
€/Stk./pcs.

Für Flach (G) Profil plat Flat back	Für Rund (R) Profil incurvé Curved back	Für Glas Epaisseur de vitre Glass thickness
00	ø 32, 42, 48 mm	2-10,76 mm

	R /mm	Best.-Nr.	€/ Stk / pcs.	
			≤ 99	≥ 100
V2A / Inox 304	00	1851-G	5,89	5,49
	32	1851-R32	5,89	5,49
	42	1851-R42	5,89	5,49
	48	1851-R48	5,89	5,49

Bitte vergessen Sie nicht, bei Ihrer Bestellung Glasstärke und Glasart (VSG oder ESG) anzugeben.
N'oubliez pas dire l'épaisseur et le type de vitre (sécurité ou laminé) dans vos commandes.
Don't forget to notify thickness and kind of glass (security or laminated) in your orders.

INOX Form 3

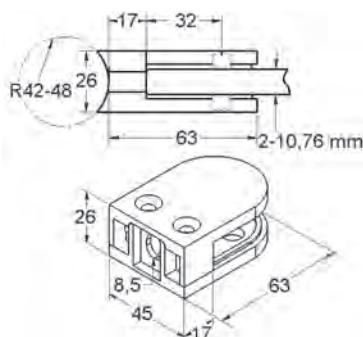

≥ 5,99
€/Stk./pcs.

Für Flach (G) Profil plat Flat back	Für Rund (R) Profil incurvé Curved back	Für Glas Epaisseur de vitre Glass thickness
00	ø 32, 42, 48 mm	2-10,76 mm

	R /mm	Best.-Nr.	€/ Stk / pcs.	
			≤ 99	≥ 100
V2A / Inox 304	00	1861-G	6,49	5,99
	32	1861-R32	6,49	5,99
	42	1861-R42	6,49	5,99
	48	1861-R48	6,49	5,99

V2A / INOX 304

INOX Form 4

≥ **8,69**
€/Stk./pcs.

Für Flach (G) Profil plat Flat back	Für Rund (R) Profil incurvé Curved back	Für Glas Epaisseur de vitre Glass thickness
00	∅ 42, 48, 60 mm	10–12,76 mm

	R /mm	Best.-Nr.	€/ Stk / pcs. ≤ 99	≥ 100
V2A / Inox 304	00	1881-G	8,99	8,69
	42	1881-R42	8,99	8,69
	48	1881-R48	8,99	8,69
	60	1881-R60	8,99	8,69

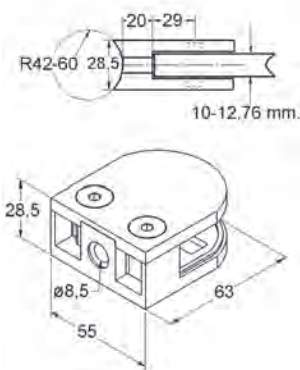

**Bitte vergessen Sie nicht, bei Ihrer Bestellung Glasstärke und Glasart (VSG oder ESG) anzugeben.
N'oubliez pas dire l'épaisseur et le type de vitre (sécurité ou laminé) dans vos commandes.
Don't forget to notify thickness and kind of glass (security or laminated) in your orders.**

für 10 mm und
12 mm ESG-
VSG Glas

INOX Form 5

≥ **9,69**
€/Stk./pcs.

Für Flach (G) Profil plat Flat back	Für Rund (R) Profil incurvé Curved back	Für Glas Epaisseur de vitre Glass thickness
00	∅ 42, 48, 60 mm	10–12,76 mm

	R /mm	Best.-Nr.	€/ Stk / pcs. ≤ 99	≥ 100
V2A / Inox 304	00	1891-G	9,99	9,69
	42	1891-R42	9,99	9,69
	48	1891-R48	9,99	9,69
	60	1891-R60	9,99	9,69

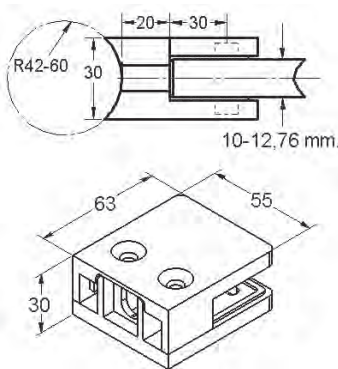

≥ **4,79**
€/Stk./pcs.

**Blechhalter
Pince de fixation
Clamp holder**



V2A / INOX 304

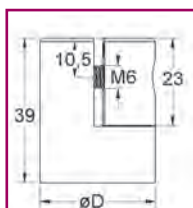

	R /mm	D = ∅ 25mm Best.-Nr.	€/ Stk / pcs.	D = ∅ 32mm Best.-Nr.	€/ Stk / pcs
V2A / Inox 304	00	1887-G	4,79	1886-G	5,99
	32	1887-R32	4,79	1886-R32	5,99
	42	1887-R42	4,79	1886-R42	5,99
	48	1887-R48	4,79	1886-R48	5,99

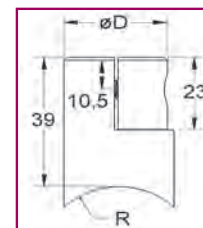

AK INOX

Klemmbefestigung Pince de vitre / Glass clamp

INOX Form 6



≥ 6,99
€/Stk./pcs.

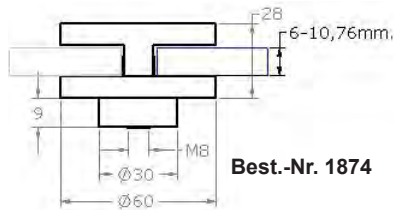

Best.-Nr. 1874

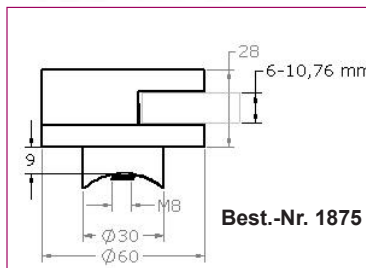

Best.-Nr. 1875

Für Flach (G)
Profil plat
Flat back

Für Rund (R)
Profil incurvé
Curved back

Für Glas
Epaisseur de vitre
Glass thickness

00	∅ 42, 48 mm	2-10,76 mm
----	-------------	------------

	R /mm	Best.-Nr.	€/ Stk / pcs. ≤ 99	≥ 100
V2A / Inox 304	00	1874-G	7,99	6,99
	42	1874-42	7,99	6,99
	48	1874-48	7,99	6,99

	R /mm	Best.-Nr.	€/ Stk / pcs. ≤ 99	≥ 100
V2A / Inox 304	00	1875-G	7,99	6,99
	42	1875-42	7,99	6,99
	48	1875-48	7,99	6,99

Klemmbefestigung unten geschlossen Pince de vitre fermer au-dessous / Glass clamp closed down

Nouveau - New
Neu

INOX Form 1



≥ 5,99
€/Stk./pcs.

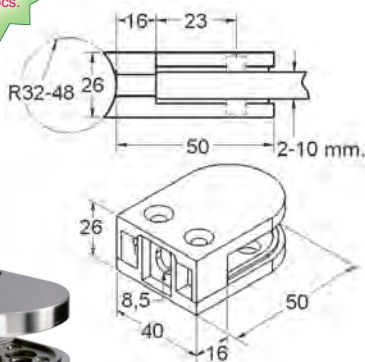

Für Flach (G)
Profil plat
Flat back

Für Rund (R)
Profil incurvé
Curved back

Für Glas
Epaisseur de vitre
Glass thickness

00	∅ 32, 42, 48 mm	2-10 mm
----	-----------------	---------

	R /mm	Best.-Nr.	€/ Stk / pcs. ≤ 99	≥ 100
V2A / Inox 304	00	1841-GL	6,49	5,99
	00	1841-GR	6,49	5,99
	33,7	1841-R32L	6,49	5,99
	33,7	1841-R32R	6,49	5,99
	42,4	1841-R42L	6,49	5,99
	42,4	1841-R42R	6,49	5,99
	48,3	1841-R48L	6,49	5,99
	48,3	1841-R48R	6,49	5,99

INOX Form 2



≥ 6,39
€/Stk./pcs.

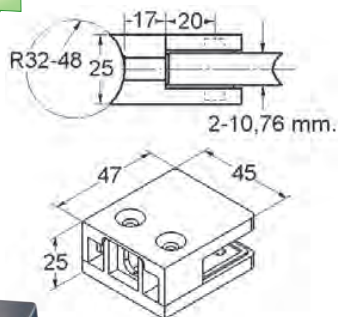

Für Flach (G)
Profil plat
Flat back

Für Rund (R)
Profil incurvé
Curved back

Für Glas
Epaisseur de vitre
Glass thickness

00	∅ 32, 42, 48 mm	2-10 mm
----	-----------------	---------

	R /mm	Best.-Nr.	€/ Stk / pcs. ≤ 99	≥ 100
V2A / Inox 304	00	1851-GL	6,89	6,39
	00	1851-GR	6,89	6,39
	33,7	1851-R32L	6,89	6,39
	33,7	1851-R32R	6,89	6,39
	42,4	1851-R42L	6,89	6,39
	42,4	1851-R42R	6,89	6,39
	48,3	1851-R48L	6,89	6,39
	48,3	1851-R48R	6,89	6,39

V2A / INOX 304

AK INOX

Klemmbefestigung unten geschlossen Pince de vitre fermer au-dessous / Glass clamp closed down

Für Flach (G) Profil plat Flat back	Für Rund (R) Profil incurvé Curved back	Für Glas Epaisseur de vitre Glass thickness
00	ø 32, 42, 48 mm	2-10 mm

	R /mm	Best.-Nr.	€ / Stk / pcs.	
			≤ 99	≥ 100
V2A / Inox 304	00	1861-GL	7,49	6,99
	00	1861-GR	7,49	6,99
	33,7	1861-R32L	7,49	6,99
	33,7	1861-R32R	7,49	6,99
	42,4	1861-R42L	7,49	6,99
	42,4	1861-R42R	7,49	6,99
	48,3	1861-R48L	7,49	6,99
	48,3	1861-R48R	7,49	6,99

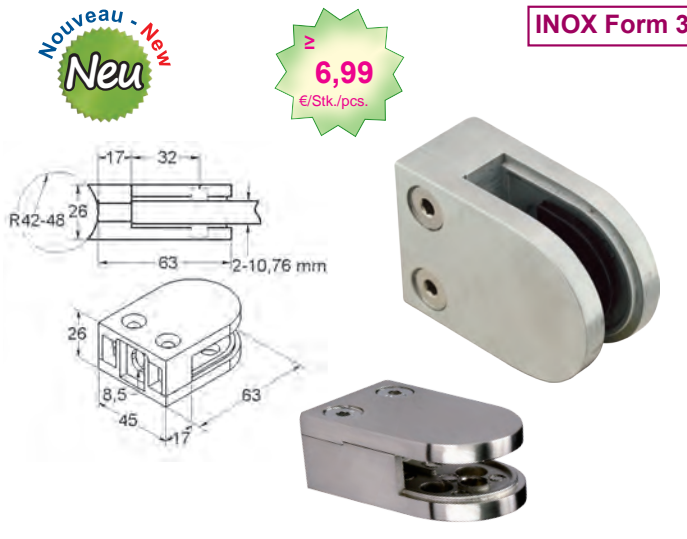

Bitte vergessen Sie nicht, bei Ihrer Bestellung Glasstärke und Glasart (VSG oder ESG) anzugeben.
N'oubliez pas dire l'épaisseur et le type de vitre (sécurité ou laminé) dans vos commandes.
Don't forget to notify thickness and kind of glass (security or laminated) in your orders.

Für Flach (G) Profil plat Flat back	Für Rund (R) Profil incurvé Curved back	Für Glas Epaisseur de vitre Glass thickness
00	ø 42, 48, 60 mm	10-12,76 mm

	R /mm	Best.-Nr.	€ / Stk / pcs.	
			≤ 99	≥ 100
V2A / Inox 304	00	1881-GL	9,99	9,49
	00	1881-GR	9,99	9,49
	42,4	1881-R42L	9,99	9,49
	42,4	1881-R42R	9,99	9,49
	48,3	1881-R48L	9,99	9,49
	48,3	1881-R48R	9,99	9,49
	60,3	1881-R60L	9,99	9,49
	60,3	1881-R60R	9,99	9,49

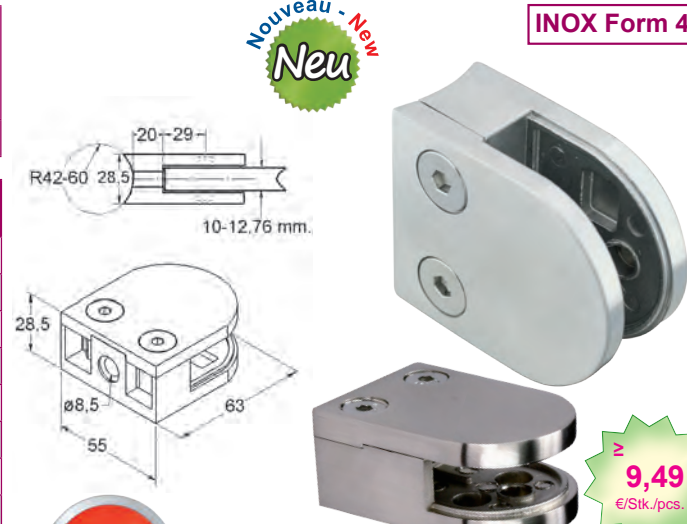

für 10 mm und 12 mm ESG-VSG Glas

Für Flach (G) Profil plat Flat back	Für Rund (R) Profil incurvé Curved back	Für Glas Epaisseur de vitre Glass thickness
00	ø 42, 48, 60 mm	10-12,76 mm

	R /mm	Best.-Nr.	€ / Stk / pcs.	
			≤ 99	≥ 100
V2A / Inox 304	00	1891-GL	10,99	9,99
	00	1891-GR	10,99	9,99
	42,4	1891-R42L	10,99	9,99
	42,4	1891-R42R	10,99	9,99
	48,3	1891-R48L	10,99	9,99
	48,3	1891-R48R	10,99	9,99
	60,3	1891-R60L	10,99	9,99
	60,3	1891-R60R	10,99	9,99

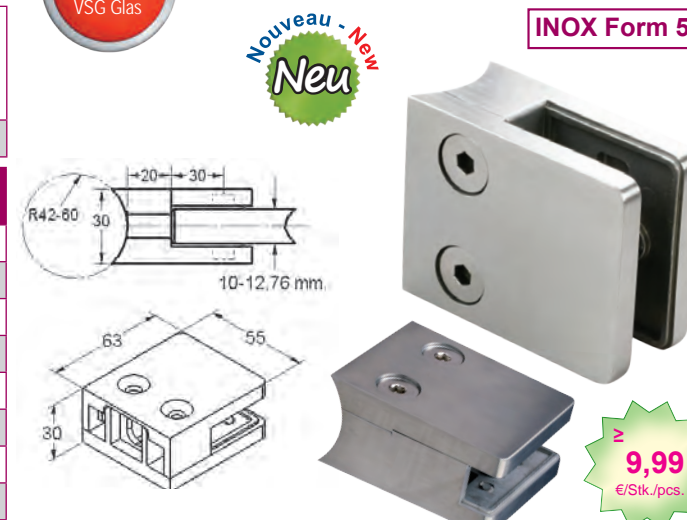

E-mail: info@akbas-schmiedeeisen.de, www.akbas-schmiedeeisen.de

Tel: +49(0) 61 44 33 05-0, Fax: +49(0) 61 44 33 05-15

Tel: +33.3.68680131, E-mail: vente@akbas-schmiedeeisen.de, Tel: +44.151.6018946, E-mail: sales@akbas-schmiedeeisen.de

Andere Oberflächen auf Anfrage
Autres surfaces sur demande / Other surfaces on request



Passende Schrauben finden Sie auf Seite 129

DIN 912 in A2

Für Flach (G) Profil plat Flat back	Für Rund (R) Profil incurvé Curved back	Für Glas Epaisseur de vitre Glass thickness
00	ø 32, 42, 48 mm	2-10 mm

ZAMAK Form 1

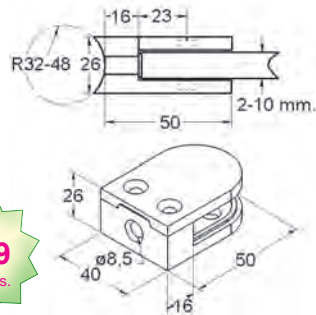

≥ **2,99**
€/Stk./pcs.

Oberfläche Revêtement Surface	R /mm	Best.-Nr.	€/ Stk / pcs. ≤ 99	≥ 100
Zink Zinc Mat Zamak	00	1811-G	3,19	2,99
	32	1811-R32	3,19	2,99
	42	1811-R42	3,19	2,99
	48	1811-R48	3,19	2,99
Edelstahl-Effekt Apparence inox Inox Visual	00	1819-G	4,19	3,99
	32	1819-R32	4,19	3,99
	42	1819-R42	4,19	3,99
	48	1819-R48	4,19	3,99
Weiss Blanc White RAL 9010	00	1812-G	4,19	3,99
	32	1812-R32	4,19	3,99
	42	1812-R42	4,19	3,99
	48	1812-R48	4,19	3,99

Für Flach (G) Profil plat Flat back	Für Rund (R) Profil incurvé Curved back	Für Glas Epaisseur de vitre Glass thickness
00	ø 32, 42, 48 mm	2-10,76 mm

ZAMAK Form 2

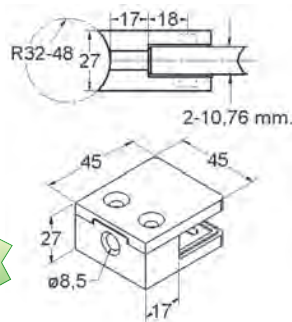

≥ **3,29**
€/Stk./pcs.

Oberfläche Revêtement Surface	R /mm	Best.-Nr.	€/ Stk / pcs. ≤ 99	≥ 100
Zink Zinc Mat Zamak	00	1821-G	3,49	3,29
	32	1821-R32	3,49	3,29
	42	1821-R42	3,49	3,29
	48	1821-R48	3,49	3,29
Edelstahl-Effekt Apparence inox Inox Visual	00	1829-G	4,69	4,39
	32	1829-R32	4,69	4,39
	42	1829-R42	4,69	4,39
	48	1829-R48	4,69	4,39
Weiss Blanc White RAL 9010	00	1822-G	4,69	4,39
	32	1822-R32	4,69	4,39
	42	1822-R42	4,69	4,39
	48	1822-R48	4,69	4,39

Oberfläche Revêtement Surface	R /mm	Best.-Nr.	€ / Stk / pcs.	
			≤ 99	≥ 100
Zink Zinc Mat Zamak	00	1831-G	3,99	3,79
	32	1831-R32	3,99	3,79
	42	1831-R42	3,99	3,79
	48	1831-R48	3,99	3,79
Edelstahl-Effekt Apparence inox Inox Visual	00	1839-G	4,99	4,79
	32	1839-R32	5,19	4,79
	42	1839-R42	5,19	4,79
	48	1839-R48	5,19	4,79
Weiss Blanc White RAL 9010	00	1832-G	5,19	4,79
	32	1832-R32	5,19	4,79
	42	1832-R42	5,19	4,79
	48	1832-R48	5,19	4,79

Für Flach (G) Profil plat Flat back	Für Rund (R) Profil incurvé Curved back	Für Glas Epaisseur de vitre Glass thickness
00	ø 32, 42, 48 mm	2-10,76 mm

ZAMAK Form 3

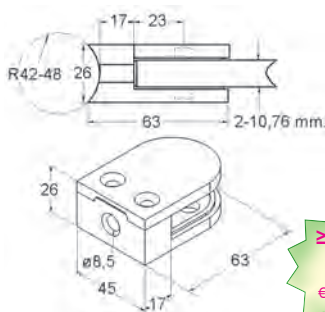

≥ 3,79
€/Stk./pcs.

Oberfläche Revêtement Surface	R /mm	Best.-Nr.	€ / Stk / pcs.	
			≤ 99	≥ 100
Zink Zinc Mat Zamak	00	1885-G	5,99	5,69
	42	1885-R42	5,99	5,69
	48	1885-R48	5,99	5,69
	60	1885-R60	5,99	5,69
Edelstahl-Effekt Apparence inox Inox Visual	00	1889-G	7,49	6,99
	42	1889-R42	7,49	6,99
	48	1889-R48	7,49	6,99
	60	1889-R60	7,49	6,99
Weiss Blanc White RAL 9010	00	1882-G	7,49	6,99
	42	1882-R42	7,49	6,99
	48	1882-R48	7,49	6,99
	60	1882-R60	7,49	6,99

Für Flach (G) Profil plat Flat back	Für Rund (R) Profil incurvé Curved back	Für Glas Epaisseur de vitre Glass thickness
00	ø 42, 48, 60 mm	10-12,76 mm

ZAMAK Form 4

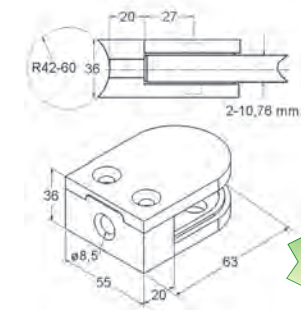

≥ 5,69
€/Stk./pcs.

Oberfläche Revêtement Surface	R /mm	Best.-Nr.	€ / Stk / pcs.	
			≤ 99	≥ 100
Zink Zinc Mat Zamak	00	1895-G	6,49	6,19
	42	1895-R42	6,49	6,19
	48	1895-R48	6,49	6,19
	60	1895-R60	6,49	6,19
Edelstahl-Effekt Apparence inox Inox Visual	00	1899-G	7,99	7,49
	42	1899-R42	7,99	7,49
	48	1899-R48	7,99	7,49
	60	1899-R60	7,99	7,49
Weiss Blanc White RAL 9010	00	1892-G	7,99	7,49
	42	1892-R42	7,99	7,49
	48	1892-R48	7,99	7,49
	60	1892-R60	7,99	7,49

Für Flach (G) Profil plat Flat back	Für Rund (R) Profil incurvé Curved back	Für Glas Epaisseur de vitre Glass thickness
00	ø 42, 48, 60 mm	10-12,76 mm

ZAMAK Form 5

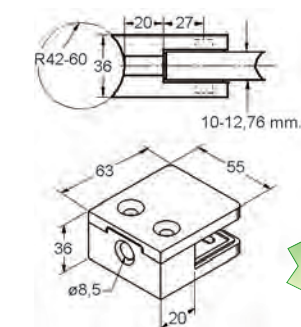

≥ 6,19
€/Stk./pcs.

E-mail: info@akbas-schmiedeeisen.de, www.akbas-schmiedeeisen.de

Tel: +49(0) 61 44 33 05-0, Fax: +49(0) 61 44 33 05-15

Tel: +33.3.68680131, E-mail: vente@akbas-schmiedeeisen.de, Tel: +44.151.6018946, E-mail: sales@akbas-schmiedeeisen.de

ZAMAK Form 1

Für Flach (G) Profil plat Flat back	Für Rund (R) Profil incurvé Curved back	Für Glas Epaisseur de vitre Glass thickness
00	ø 32, 42 mm	2-10 mm



Nouveau - New
Neu

Oberfläche Revêtement Surface	R /mm	Best.-Nr.	€/ Stk / pcs.	
			≤ 99	≥ 100
Zink Zinc Mat Zamak	00	1811-GL	4,19	3,99
	00	1811-GR	4,19	3,99
	33,7	1811-R33L	4,19	3,99
	33,7	1811-R33R	4,19	3,99
	42,4	1811-R42L	4,19	3,99
	42,4	1811-R42R	4,19	3,99
Edelstahl-Effekt Apparence inox Inox Visual	00	1819-GL	5,19	4,99
	00	1819-GR	5,19	4,99
	33,7	1819-R33L	5,19	4,99
	33,7	1819-R33R	5,19	4,99
	42,4	1819-R42L	5,19	4,99
	42,4	1819-R42R	5,19	4,99

Bitte vergessen Sie nicht, bei Ihrer Bestellung Glasstärke und Glasart (VSG oder ESG) anzugeben.
N'oubliez pas dire l'épaisseur et le type de vitre (sécurité ou laminé) dans vous commandes.
Don't forget to notify thickness and kind of glass (security or laminated) in your orders.

ZAMAK Form 2

Für Flach (G) Profil plat Flat back	Für Rund (R) Profil incurvé Curved back	Für Glas Epaisseur de vitre Glass thickness
00	ø 42 mm	2-10,76 mm

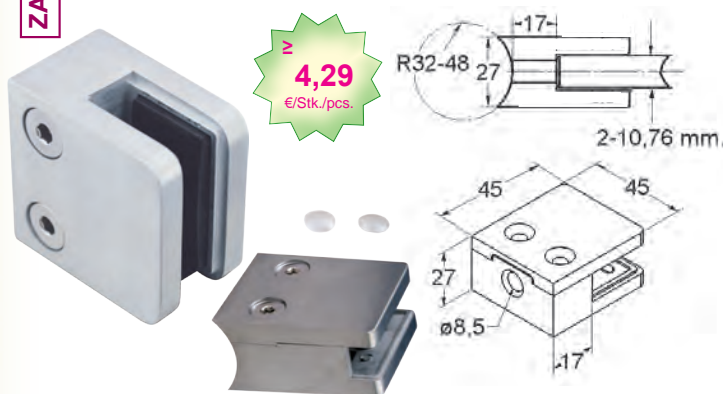

Oberfläche Revêtement Surface	R /mm	Best.-Nr.	€/ Stk / pcs.	
			≤ 99	≥ 100
Zink Zinc Mat Zamak	00	1821-GL	4,49	4,29
	00	1821-GR	4,49	4,29
	42,4	1821-R42L	4,49	4,29
	42,4	1821-R42R	4,49	4,29
Edelstahl-Effekt Apparence inox Inox Visual	00	1829-GL	5,69	5,49
	00	1829-GR	5,69	5,49
	42,4	1829-R42L	5,69	5,49
	42,4	1829-R42R	5,69	5,49

Nouveau - New
Neu

ZAMAK Form 3

Für Flach (G) Profil plat Flat back	Für Rund (R) Profil incurvé Curved back	Für Glas Epaisseur de vitre Glass thickness
00	ø 32, 42 mm	2-10,76 mm



Oberfläche Revêtement Surface	R /mm	Best.-Nr.	€/ Stk / pcs.	
			≤ 99	≥ 100
Zink Zinc Mat Zamak	00	1831-GL	4,99	4,79
	00	1831-GR	4,99	4,79
	33,7	1831-R33L	4,99	4,79
	33,7	1831-R33R	4,99	4,79
	42,4	1831-R42L	4,99	4,79
	42,4	1831-R42R	4,99	4,79
Edelstahl-Effekt Apparence inox Inox Visual	00	1839-GL	6,19	5,99
	00	1839-GR	6,19	5,99
	33,7	1839-R33L	6,19	5,99
	33,7	1839-R33R	6,19	5,99
	42,4	1839-R42L	6,19	5,99
	42,4	1839-R42R	6,19	5,99



Klemmbefestigung unten geschlossen Pince de vitre fermer au-dessous / Glass clamp closed down



Wir danken der Fa. Ebert Metalldesign

Bitte vergessen Sie nicht, bei Ihrer Bestellung Glasstärke und Glasart (VSG oder ESG) anzugeben.
N'oubliez pas de dire l'épaisseur et le type de vitre (sécurité ou laminé) dans vos commandes.
Don't forget to notify thickness and kind of glass (security or laminated) in your orders.

Oberfläche Revêtement Surface	R /mm	Best.-Nr.	€/ Stk / pcs.	
			≤ 99	≥ 100
Zink Zinc Mat Zamak	00	1885-GL	6,99	6,79
	00	1885-GR	6,99	6,79
	42,4	1885-R42L	6,99	6,79
	42,4	1885-R42R	6,99	6,79
	48,3	1885-R48L	6,99	6,79
Edelstahl-Effekt Apparence inox Inox Visual	00	1889-GL	8,49	8,29
	00	1889-GR	8,49	8,29
	42,4	1889-R42L	8,49	8,29
	42,4	1889-R42R	8,49	8,29
	48,3	1889-R48L	8,49	8,29

Für Flach (G) Profil plat Flat back	Für Rund (R) Profil incurvé Curved back	Für Glas Epaisseur de vitre Glass thickness
00	∅ 42, 48, 60 mm	10-12,76 mm

ZAMAK Form 4

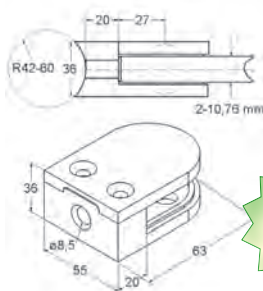

≥ 6,79
€/Stk./pcs.



Nouveau - New
Neu

Oberfläche Revêtement Surface	R /mm	Best.-Nr.	€/ Stk / pcs.	
			≤ 99	≥ 100
Zink Zinc Mat Zamak	00	1895-GL	7,49	7,29
	00	1895-GR	7,49	7,29
	42,4	1895-R42L	7,49	7,29
	42,4	1895-R42R	7,49	7,29
	48,3	1895-R48L	7,49	7,29
Edelstahl-Effekt Apparence inox Inox Visual	00	1899-GL	8,99	8,79
	00	1899-GR	8,99	8,79
	42,4	1899-R42L	8,99	8,79
	42,4	1899-R42R	8,99	8,79
	48,3	1899-R48L	8,99	8,79

Für Flach (G) Profil plat Flat back	Für Rund (R) Profil incurvé Curved back	Für Glas Epaisseur de vitre Glass thickness
00	∅ 42, 48, 60 mm	10-12,76 mm

ZAMAK Form 5

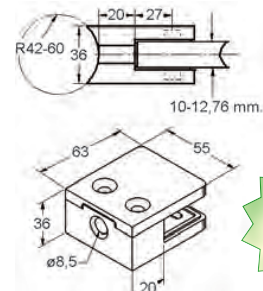

≥ 7,29
€/Stk./pcs.



E-mail: info@akbas-schmiedeeisen.de, www.akbas-schmiedeeisen.de

Tel: +49(0) 61 44 33 05-0, Fax: +49(0) 61 44 33 05-15

Tel: +33.3.68680131, E-mail: vente@akbas-schmiedeeisen.de, Tel: +44.151.6018946, E-mail: sales@akbas-schmiedeeisen.de

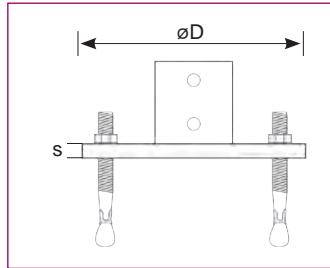

Auslieferung ohne Befestigungsschrauben
und Abdeckrosetten
Livraison sans vis de fixation et rosaces
Delivery without mounting screws and
Cover plates

øD x s /mm	Rohr/Tube /mm	Best.-Nr.	€/ Stk / pcs.
80 x 6	33,7x2,0	1966-33	8,99
100 x 6	42,4x2,0	1966-42	9,99
120 x 6	48,3x2,0	1966-48	11,99

≥ 8,99
€/Stk./pcs.

V2A / INOX 304

≥ 8,99
€/Stk./pcs.

Nouveau - New
Neu

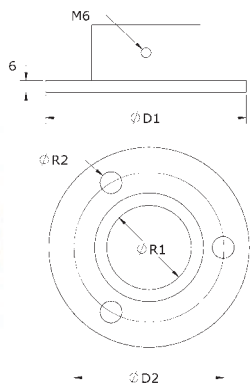

øD1 x s /mm	D2 /mm	H /mm	R2 /mm	R1 /mm	Best.-Nr.	€/ Stk / pcs.
80 x 6	57	25	9	33,7x2,0	1967-1-33	8,99
100 x 6	66	25	11	42,4x2,0	1967-1-42	9,99

≥ 7,99
€/Stk./pcs.

Nouveau - New
Neu

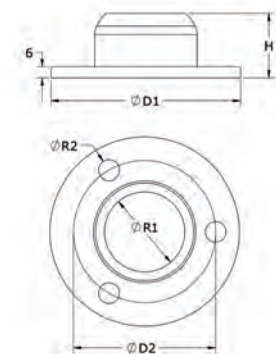

øD1 x s /mm	D2 /mm	H /mm	R2 /mm	R1 /mm	Best.-Nr.	€/ Stk / pcs.
80 x 6	57	21	9	33,7x2,0	1967-2-33	7,99
100 x 6	66	21	11	42,4x2,0	1967-2-42	8,99

Stift / Rallonge / Extension bar

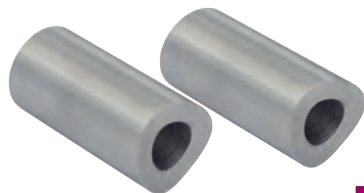

≥ 1,79
€/Stk./pcs.

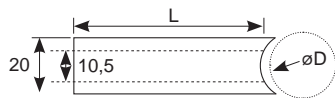

L /mm	øD /mm	Best.-Nr.	€/ Stk / pcs.
40	33,7	1969-40	1,79
70	42,4	1969-70	2,49
100	48,3	1969-100	2,79



“ecoline”

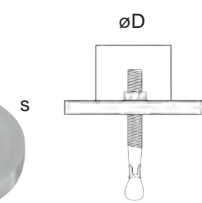

Auslieferung ohne Abdeckrosetten
Livraison sans rosaces
Delivery without cover plates

≥ 6,69
€/Stk./pcs.

øD x s /mm	Rohr/Tube /mm	Best.-Nr.	€/ Stk / pcs.
80 x 6	33,7x2,0	1968-33	6,69
100 x 6	42,4x2,0	1968-42	7,49
120 x 6	48,3x2,0	1968-48	9,49





14,99
€/Stk./pcs.

øB /mm	Best.-Nr.	€ / Stk / pcs.
34	1963-33	14,99
43	1963-42	14,99
49	1963-48	14,99



14,99
€/Stk./pcs.

Rohr/Tube /mm	Best.-Nr.	€ / Stk / pcs.
33,7	1961-33	14,99
42,4	1961-42	14,99
48,3	1961-48	14,99



14,99
€/Stk./pcs.

Rohr/Tube /mm	Best.-Nr.	€ / Stk / pcs.
33,7	1960-33	14,99
42,4	1960-42	14,99
48,3	1960-48	14,99



≥ 22,99
€/Stk./pcs.

øB /mm	Best.-Nr.	€ / Stk / pcs.
33,7	1962-33	22,99
42,4	1962-42	25,99
48,3	1962-48	29,99



14,99
€/Stk./pcs.

øB /mm	Best.-Nr.	€ / Stk / pcs.
33,7	1964-33	14,99
42,4	1964-42	14,99
48,3	1964-48	14,99

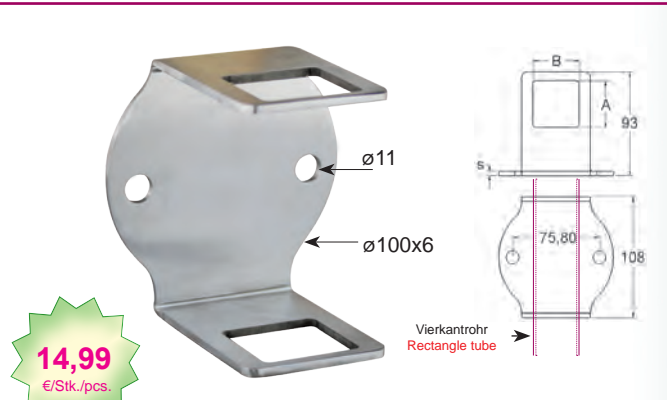

14,99
€/Stk./pcs.

A /mm	B /mm	Best.-Nr.	€ / Stk / pcs.
30	30	1965-30	14,99
40	40	1965-40	14,99

AK INOX

Stanzteile Platines / Plates

Alle Ronden mit „plus Service“
Kanten bearbeitet!

≥ 1,99
€/Stk./pcs.

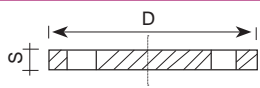

Alle Ronden mit „plus Service“ Kanten bearbeitet!
All plates with „plus Service“ smoothed edges!



Best.-Nr. 1120



Best.-Nr. 1121

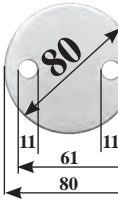

Best.-Nr. 1122



Best.-Nr. 1123



Best.-Nr. 1124

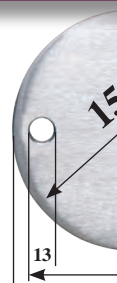

Best.-Nr. 1128

D x s /mm	Best.-Nr.	€/ Stk / pcs.	≤ 99	≥ 100
70 x 4	1120	2,19	1,99	
70 x 6	1121	2,49	2,29	
80 x 6	1122	2,89	2,69	



D x s /mm	Best.-Nr.	€/ Stk / pcs.	≤ 79	≥ 80
100 x 6	1123	3,99	3,79	

D x s /mm	Best.-Nr.	€/ Stk / pcs.	≤ 49	≥ 50
120 x 6	1124	5,69	5,29	
150 x 6	1128	7,69	7,49	

≥ 3,89
€/Stk./pcs.

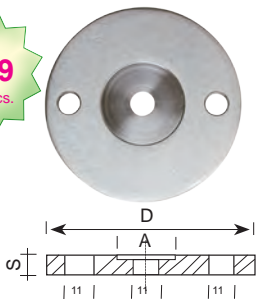

D x s /mm	A /mm	Best.-Nr.	€/ Stk / pcs.
80 x 6	34 x 1	1127-34	3,89
100 x 6	43 x 1	1127-43	4,69
120 x 6	49 x 1	1127-49	6,69

≥ 1,99
€/Stk./pcs.

D x s /mm	Best.-Nr.	€/ Stk / pcs.	≤ 99	≥ 100
70 x 4	1130	2,19	1,99	

D x s /mm	Best.-Nr.	€/ Stk / pcs.	≤ 99	≥ 100
80 x 6	1131	3,39	3,19	

D x s /mm	A /mm	Best.-Nr.	€/ Stk / pcs.	≤ 79	≥ 80
100 x 6	34	1132-34	4,99	4,49	
100 x 6	43	1132-43	4,99	4,49	
100 x 6	49	1132-49	4,99	4,49	

D x s /mm	A /mm	Best.-Nr.	€/ Stk / pcs.	≤ 79	≥ 80
120 x 6	34	1133-34	6,49	5,99	
120 x 6	43	1133-43	6,49	5,99	
120 x 6	49	1133-49	6,49	5,99	

D x s /mm	Best.-Nr.	€/ Stk / pcs.	≤ 99	≥ 100
64 x 4	1125	2,49	2,39	
64 x 4	1126	2,49	2,39	

Bohrungen angesenkt!

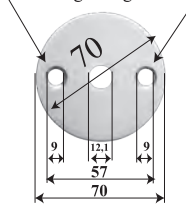

Best.-Nr. 1130

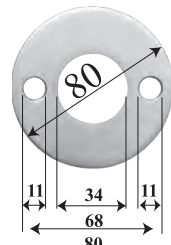

Best.-Nr. 1131

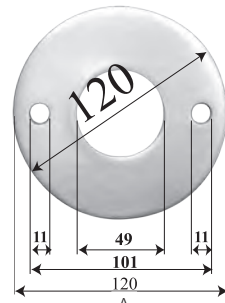
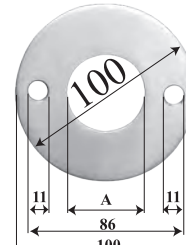

Best.-Nr. 1125

Toutes les platines avec „plus Service“
traitement aux bordures!

≥ 0,37
€/Stk./pcs.

D x s /mm	Best.-Nr.	€/ Stk / pcs.	≤ 99	≥ 100
27 x 2	1111	0,41	0,37	
33 x 2	1112	0,50	0,46	
33 x 4	1100	0,57	0,53	
42 x 2	1113	0,63	0,59	
42 x 4	1101	0,71	0,67	
48 x 4	1102	0,93	0,89	
60 x 4	1103	1,53	1,49	
70 x 4	1104	1,83	1,79	
70 x 6	1105	2,23	2,19	
80 x 4	1106	2,23	2,19	
80 x 6	1107	2,53	2,49	
100 x 4	1108	3,45	3,29	

D x s /mm	Best.-Nr.	€/ Stk / pcs.	≤ 79	≥ 80
100 x 6	1109	4,19	3,89	

D x s /mm	Best.-Nr.	€/ Stk / pcs.	≤ 49	≥ 50
120 x 6	1110	5,69	5,19	
150 x 6	1114	7,69	7,29	

Schale gewölbt, ungeschliffen
Embout bombé, non poli / Domed cap, unpolished

≥ 0,29
€/Stk./pcs.

ø /mm	h /mm	Zoll	Best.-Nr.	€/ Stk / pcs.	≤ 99	≥ 100
21	6	½"	1200-21	0,34	0,29	
27	7	¾"	1200-27	0,37	0,32	
33	8	1"	1200-33	0,43	0,38	
42	9	1 ¼"	1200-42	0,53	0,48	
48	10	1 ½"	1200-48	0,59	0,54	
52	10	1 ¾"	1200-52	0,64	0,59	
60	11	2"	1200-60	0,76	0,71	
70	11	2 ¼"	1200-70	0,99	0,94	
76	11	2 ½"	1200-76	1,17	1,12	
89	12	3"	1200-89	1,74	1,69	
101	12	3 ½"	1200-101	2,49	2,34	
113	13	4"	1200-113	2,69	2,49	
120	13	4 ½"	1200-120	3,15	2,99	



Material 2,0 mm

V2A / INOX 304

All plates with „plus Service“ smoothed edges !

B x H x s /mm	Best.-Nr.	€/ Stk / pcs. ≤ 99	≥ 100
100x50x6	1140	2,69	2,49
120x60x6	1141	3,39	3,19

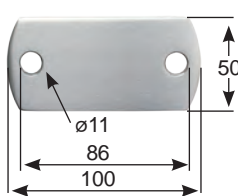

Best.-Nr. 1140

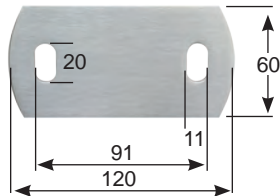

Best.-Nr. 1141

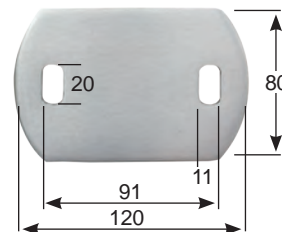

Best.-Nr. 1142

B x H x s /mm	Best.-Nr.	€/ Stk / pcs. ≤ 79	≥ 80
120x80x6	1142	4,29	3,99

B x H x s /mm	Best.-Nr.	€/ Stk / pcs. ≤ 39	≥ 40
150x100x6	1145	6,69	6,29

B x H x s /mm	Best.-Nr.	€/ Stk / pcs. ≤ 24	≥ 25
200x125x6	1146	9,49	8,99

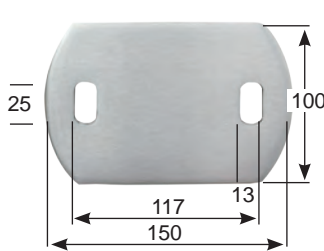

Best.-Nr. 1145

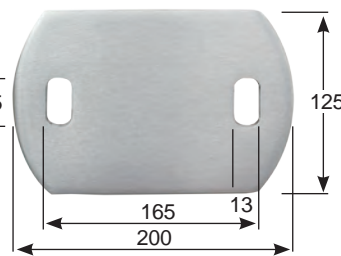

Best.-Nr. 1146

Best.-Nr. 1143

≥ 4,39 €/Stk./pcs.

Best.-Nr. 1144

B x H x s /mm	Best.-Nr.	€/ Stk / pcs. ≤ 64	≥ 65
100x100x6	1143	4,69	4,39

B x H x s /mm	Best.-Nr.	€/ Stk / pcs. ≤ 43	≥ 44
120x120x6	1144	6,19	5,99

Best.-Nr. 1150

Best.-Nr. 1151

Best.-Nr. 1152

Best.-Nr. 1153

Best.-Nr. 1154

Nouveau - New Neu

≥ 0,74 €/Stk./pcs.

B x H x s /mm	Best.-Nr.	€/ Stk / pcs. ≤ 99	≥ 100
50 x 30 x 4	1150	0,79	0,74
50 x 30 x 4	1151	0,79	0,74
30 x 20 x 4	1152	0,64	0,59
85 x 40 x 5	1153	1,39	1,14
100 x 55 x 5	1154	1,89	1,69
50 x 30 x 4 Ø42	1155	0,99	0,94
50 x 30 x 4 Ø42	1156	0,99	0,94

Best.-Nr. 1146-OB

Best.-Nr. 1145-OB

Best.-Nr. 1142-OB

≥ 3,99 €/Stk./pcs.

øD x s /mm	Best.-Nr.	€/Stk /pcs	Paket/Stk/ paquet	Paketabnahme / Stk / pcs
100x100x6	1143-OB	4,39	65	3,99
120x 80x6	1142-OB	3,99	100	3,79
120x120x6	1144-OB	5,99	44	5,79
150x100x6	1145-OB	6,99	40	6,49
200x125x6	1146-OB	9,99	25	9,49

Best.-Nr. 1160

Best.-Nr. 1161

Best.-Nr. 1162

Best.-Nr. 1163

Best.-Nr. 1164

≥ 1,89 €/Stk./pcs.

B x H x s /mm	Best.-Nr.	€/ Stk / pcs. ≤ 99	≥ 100
70 x 45 x 4	1160	1,99	1,89
80 x 50 x 4	1161	2,19	2,09

B x H x s /mm	Best.-Nr.	€/ Stk / pcs. ≤ 79	≥ 80
100 x 60 x 6	1162	2,69	2,49
120 x 80 x 6	1163	4,29	3,99

B x H x s /mm	Best.-Nr.	€/ Stk / pcs. ≤ 49	≥ 50
150 x 100 x 6	1164	5,99	5,49

E-mail: info@akbas-schmiedeeisen.de, www.akbas-schmiedeeisen.de

Tel: +49(0) 61 44 33 05-0, Fax: +49(0) 61 44 33 05-15

Tel: +33.3.68680131, E-mail: vente@akbas-schmiedeeisen.de, Tel: +44.151.6018946, E-mail: sales@akbas-schmiedeeisen.de

AK INOX

Rohrbögen / Tubes incurvés / Curved tubes

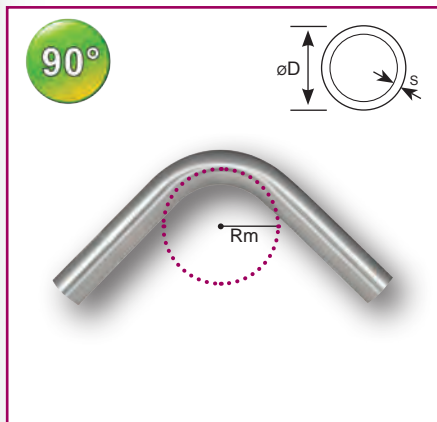

øD x s /mm	Rm	Best.-Nr.	€/Stk /pcs
26,9 x 2,0	54	1904-26	9,99
33,7 x 2,0	68	1904-33	11,99
33,7 x 2,6	68	1904-3326	12,99
42,4 x 2,0	86	1904-42	12,99
42,4 x 2,6	86	1904-4226	14,99
48,3 x 2,6	98	1904-48	17,99



øD x s /mm	Rm	Best.-Nr.	€/Stk /pcs
26,9 x 2,0	54	1905-26	10,99
33,7 x 2,0	68	1905-33	12,49
33,7 x 2,6	68	1905-3326	13,99
42,4 x 2,0	86	1905-42	13,99
42,4 x 2,6	86	1905-4226	15,99
48,3 x 2,6	98	1905-48	19,99



øD x s /mm	Rm	Best.-Nr.	€/Stk /pcs
26,9 x 2,0	54	1906-26	10,99
33,7 x 2,0	68	1906-33	13,49
33,7 x 2,6	68	1906-3326	14,99
42,4 x 2,0	86	1906-42	14,99
42,4 x 2,6	86	1906-4226	17,99
48,3 x 2,6	98	1906-48	21,99



øD x s /mm	Rm	Best.-Nr.	€/Stk /pcs
26,9 x 2,0	54	1901-26	9,99
33,7 x 2,0	68	1901-33	11,49
33,7 x 2,6	68	1901-3326	12,49
42,4 x 2,0	86	1901-42	12,49
42,4 x 2,6	86	1901-4226	13,49
48,3 x 2,6	98	1901-48	16,49



øD x s /mm	Rm	Best.-Nr.	€/Stk /pcs
26,9 x 2,0	54	1902-26	9,99
33,7 x 2,0	68	1902-33	11,49
33,7 x 2,6	68	1902-3326	12,49
42,4 x 2,0	86	1902-42	12,49
42,4 x 2,6	86	1902-4226	13,49
48,3 x 2,6	98	1902-48	16,49



øD x s /mm	Rm	Best.-Nr.	€/Stk /pcs
26,9 x 2,0	54	1903-26	9,99
33,7 x 2,0	68	1903-33	11,49
33,7 x 2,6	68	1903-3326	12,49
42,4 x 2,0	86	1903-42	12,49
42,4 x 2,6	86	1903-4226	13,49
48,3 x 2,6	98	1903-48	16,49

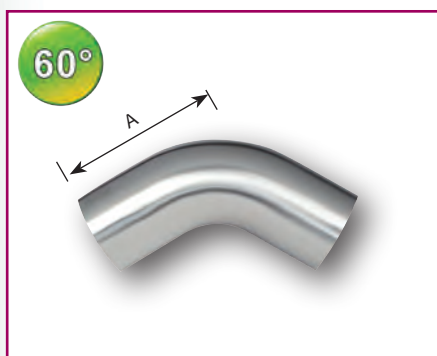

øD x s /mm	A	Best.-Nr.	€/Stk /pcs
42,4 x 2,0	79	1903-42-K	4,99



øD x s /mm	A	Best.-Nr.	€/Stk /pcs
42,4 x 2,0	73	1902-42-K	4,99

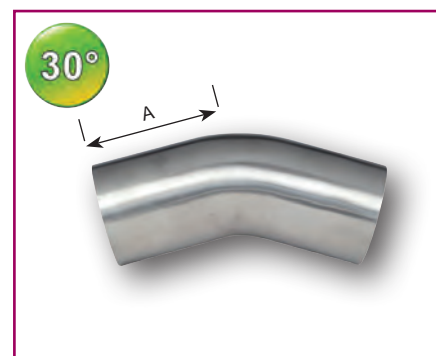

øD x s /mm	A	Best.-Nr. Code	€/Stk /pcs
42,4 x 2,0	73	1901-42-K	4,99

V2A / INOX 304

AK INOX

Rohrbögen / Tubes incurvés / Curved tubes

Schweißbogen
Coude / Elbow
HP- Hochglanz
Haut polissage / Highly polished
Poliert
Poli / Polished
* = nicht poliert
pas poli
not polished

Top
≥ 1,79
€/Stk./pcs.



øD x s /mm	Rm	Best.-Nr	€/ Stk /pcs.
25,0 x 2,0	26	1924-25	1,79
26,9 x 2,0	27	1924-26	1,99
32,0 x 1,5	38	1924-32	1,99
32,0 x 1,5	38	1924-32HP	2,29
33,7 x 2,0	35	1924-33	2,49
42,4 x 2,0	44	1924-42	2,79
48,3 x 2,6	54	1924-48	3,29
50,8 x 1,5	58	1924-51	2,69
50,8 x 1,5	58	1924-51HP	2,99
*60,3 x 2,0	44	1924-60	4,99

øD x s /mm	Best.-Nr.	€/ Stk / pcs
33,7 x 2,0	1924-3345	1,99
42,4 x 2,0	1924-4245	2,49
48,3 x 2,0	1924-4845	2,99

AK INOX

Rohrbögen mit Bohrung Tubes incurvés percés / Tube fittings with holes

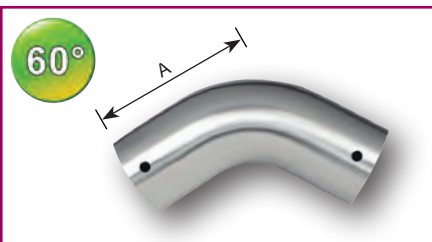

øD x s /mm	A /mm	Best.-Nr.	€/Stk /pcs
42,4 x 2,0	79	1903-42-KB	4,99

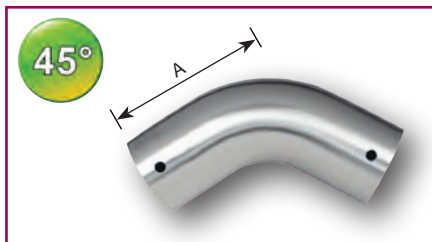

øD x s /mm	A /mm	Best.-Nr.	€/Stk /pcs
42,4 x 2,0	73	1902-42-KB	4,99

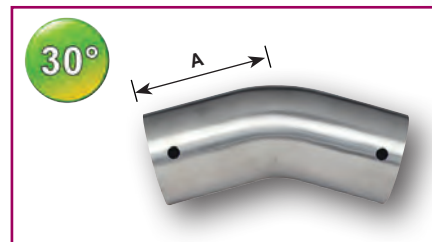

øD x s /mm	A /mm	Best.-Nr.	€/Stk /pcs
42,4 x 2,0	73	1901-42-KB	4,99

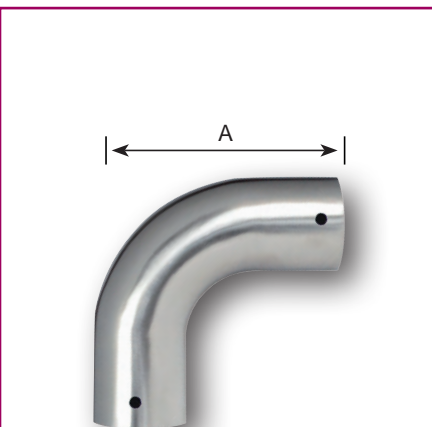

øD x s /mm	A /mm	Best.-Nr.	€/Stk /pcs
42,4 x 2,0	110	1904-42-KB	4,99

Verbindungshülse / Raccord / Connector



Mit Klemmschrauben
Avec vis de serrage / With clamp screws

Passend für Rohrwandstärke 2,0–2,6 mm
Convient à une épaisseur de tube de 2,0 à 2,6 mm
Suitable for 2,0-2,6 mm thickness of tube

Verbindungshülse einstecken und Gewindestift (im Lieferumfang enthalten) festziehen.
Fertig ist die Verbindung in Sekunden!
Manchon de raccordement insérer et vis fileté (inclus à la livraison) serrer.
Fixation terminée en secondes!

8 mm vorgebohrt für Aufnahme der Verbindungshülse
Trou de 8 mm sur le tube
8 mm hole on the face of tube



Rohr/Tube /mm	Best.-Nr.	€/Stk /pcs
26,9	1951-26	3,49
33,7	1951-33	3,49
42,4	1951-42	3,99
48,3	1951-48	4,49

E-mail: info@akbas-schmiedeeisen.de, www.akbas-schmiedeeisen.de

Tel: +49(0) 61 44 33 05-0, Fax: +49(0) 61 44 33 05-15

Tel: +33.3.68680131, E-mail: vente@akbas-schmiedeeisen.de, Tel: +44.151.6018946, E-mail: sales@akbas-schmiedeeisen.de

AK INOX

Steckfittings / Raccords / Tube fittings

Kleber auftragen und einstecken, fertig !!
 Appliquez de la colle et insert, fini !!
 Apply glue and insert, finished !!



Rohr/Tube /mm	90 - 145° Best.-Nr.	100 - 165° Best.-Nr.	€/Stk /pcs
33,7 x 2,0	1937-1-33	1937-2-33	11,99
42,4 x 2,0	1937-1-42	1937-2-42	13,49
48,3 x 2,0	1937-1-48	1937-2-48	14,99



Rohr/Tube /mm	Best.-Nr.	€/Stk /pcs
33,7 x 2,0	1938-33	14,99
42,4 x 2,0	1938-42	16,99
48,3 x 2,0	1938-48	19,99



Rohr/Tube /mm	Best.-Nr.	€/Stk /pcs
33,7 x 2,0	1936-33	9,99
42,4 x 2,0	1936-42	13,49
48,3 x 2,0	1936-48	14,99

V2A / INOX 304



Rohr/Tube /mm	Best.-Nr.	€/Stk /pcs
33,7 x 2,0	1933-33	11,99
42,4 x 2,0	1933-42	13,49
48,3 x 2,0	1933-48	14,99



Rohr/Tube /mm	Best.-Nr.	€/Stk /pcs
33,7	1930-33	12,99
42,4	1930-42	14,99
48,3	1930-48	15,99



Rohr/Tube /mm	Best.-Nr.	€/Stk /pcs
33,7	1931-33	16,99
42,4	1931-42	18,49
48,3	1931-48	19,99

Passend für Rohrwandstärke 2,0–2,6 mm
 Convient à une épaisseur de tube de 2,0 à 2,6 mm
 Suitable for 2,0-2,6 mm thickness of tube

AK-Bond Anaerober-Klebstoff

1-Komponenten, anaerob aushärtender Kleb- und Dichtstoff speziell für Metallverbindungen.
 1-composant, anaérobie durcissement de colles et Scellant conçu pour composés métalliques
 1-component, anaerobic curing adhesives and Sealant designed for metal compounds

Nouveau - New Neu



9,95 €/Stk./pcs.

Inhalt	Best.-Nr.	€/Stk / pcs.
50 ml	25117	9,95



für Rohr	Best.-Nr.	€/Stk /pcs
33,7 x 2,0 mm	1913-33V	12,49
42,4 x 2,0 mm	1913-42V	14,49
48,3 x 2,0 mm	1913-48V	16,49



øD/mm	øB/mm	Best.-Nr.	€/Stk /pcs
16 mm	10,2 mm	1939-10	2,99
16 mm	12,2 mm	1939-12	2,99

AK INOX

Steckfittings / Raccords / Tube fittings



Rohr Tube /mm	Best.-Nr.	€/Stk /pcs
33,7 x 2,0	1911-33	4,99
42,4 x 2,0	1911-42	5,99
48,3 x 2,0	1911-48	6,99



Rohr Tube /mm	Best.-Nr.	€/Stk /pcs
33,7 x 2,0	1910-33	5,99
42,4 x 2,0	1910-42	6,99
48,3 x 2,0	1910-48	7,99

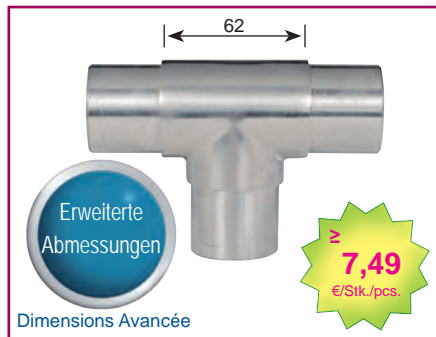

für Rohr	Best.-Nr.	€/Stk /pcs
33,7 x 2,0 mm	1913-33	7,49
42,4 x 2,0 mm	1913-42	9,49
48,3 x 2,0 mm	1913-48	11,49



Rohr Tube /mm	Best.-Nr.	€/Stk /pcs
33,7 x 2,0	1918-33	9,99
42,4 x 2,0	1918-42	11,99
48,3 x 2,0	1918-48	13,99



Rohr Tube /mm	Best.-Nr.	€/Stk /pcs
33,7 x 2,0	1919-33	6,99
42,4 x 2,0	1919-42	7,99
48,3 x 2,0	1919-48	8,99



Rohr Tube /mm	Best.-Nr.	€/Stk /pcs
33,7 x 2,0	1912-33	4,99
42,4 x 2,0	1912-42	5,99
48,3 x 2,0	1912-48	6,99

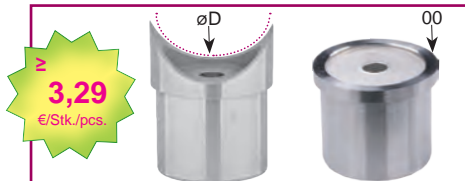

Rohr Tube /mm	øD/mm	Best.-Nr.	€/Stk /pcs
33,7 x 2,0	33,7 x 2,0	1916-33	3,29
33,7 x 2,0	42,4 x 2,0	1916-3342	3,79
33,7 x 2,0	00	1916-33G	3,29
42,4 x 2,0	42,4 x 2,0	1916-42	3,79
42,4 x 2,0	00	1916-42G	3,79
48,3 x 2,0	48,3 x 2,0	1916-48	4,79

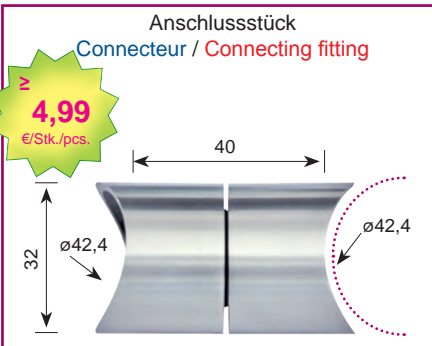

Rohr Tube /mm	Best.-Nr.	€/Stk /pcs
42,4-42,4	1925-4242	4,99

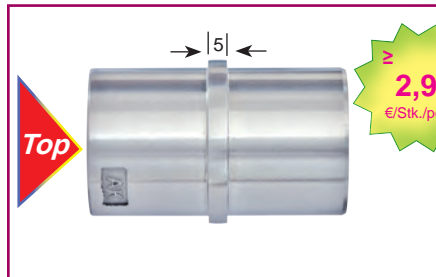

Rohr Tube /mm	Best.-Nr.	€/Stk /pcs
33,7 x 2,0	1917-33	2,99
42,4 x 2,0	1917-42	3,29
48,3 x 2,0	1917-48	3,79



für Rohr	Best.-Nr.	€/Stk /pcs
42,4 x 2,0 mm	1915-42	9,99
48,3 x 2,0 mm	1915-48	12,99



Für Rohr / Tube 42,4 x 2,0 mm
Best.-Nr. 1914-42

V2A / INOX 304

E-mail: info@akbas-schmiedeeisen.de, www.akbas-schmiedeeisen.de

Tel: +49(0) 61 44 33 05-0, Fax: +49(0) 61 44 33 05-15

Tel: +33.3.68680131, E-mail: vente@akbas-schmiedeeisen.de, Tel: +44.151.6018946, E-mail: sales@akbas-schmiedeeisen.de

AK INOX

Vierkant-Steckfittings / Carré Raccords / Square tube fittings

45°



Kleber auftragen und einstecken, fertig !!
Appliquez de la colle et insert, fini !!
Apply glue and insert, finished !!

Nouveau - New
Neu

90°



für Rohr	Best.-Nr.	€/Stk / pcs
40 x 40 x 2,0 mm	1072-4040	6,99

für Rohr	Best.-Nr.	€/Stk / pcs
40 x 40 x 2,0 mm	1071-4040	7,69

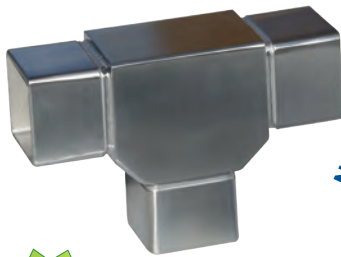

9,99

€/Stk./pcs.

Nouveau - New
Neu

11,99

€/Stk./pcs.



Nouveau - New
Neu



4,99

€/Stk./pcs.

für Rohr	Best.-Nr.	€/Stk / pcs
40 x 40 x 2,0 mm	1073-4040	9,99

für Rohr	Best.-Nr.	€/Stk / pcs
40 x 40 x 2,0 mm	1075-4040	11,99

für Rohr	Best.-Nr.	€/Stk / pcs
40 x 40 x 2,0 mm	1077-4040	4,99

Abdeckkappen Embouts pyramidaux / Angular caps

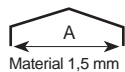
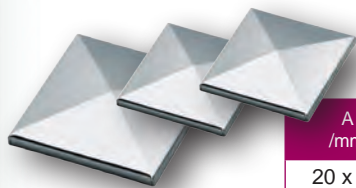

≥ 0,99

€/Stk./pcs.

A /mm	Best.-Nr.	€/ Stk / pcs.
20 x 30	1660-2030	0,99
30 x 30	1660-3030	1,09
30 x 40	1660-3040	1,29
30 x 50	1660-3050	1,49
40 x 40	1660-4040	1,49
50 x 50	1660-5050	1,69
60 x 40	1660-6040	1,69
60 x 60	1660-6060	1,89
80 x 80	1660-8080	2,29
100 x 100	1660-1010	2,79
120 x 120	1660-1212	3,29



≥ 2,49

€/Stk./pcs.

Nouveau - New
Neu

Abmessung für Vierkanrohr / mm	øM /mm	Best.-Nr.	€/Stk / pcs
30 x 30 x 2,0	-	1070-3030	2,49
40 x 40 x 2,0	-	1070-4040	2,79
30 x 30 x 2,0	8	1070-3030-G	2,99
40 x 40 x 2,0	8	1070-4040-G	3,29

V2A / INOX 304

AK INOX

Holzhandlaufverbinder / Connecteur pour main courante en bois
Connectors for wood handrail

Neu im Programm

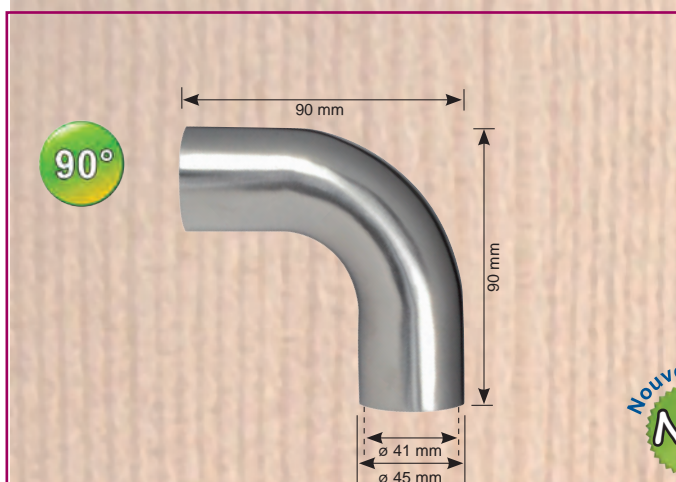

Best.-Nr.	€/ Stk / pcs.
1080	6,99

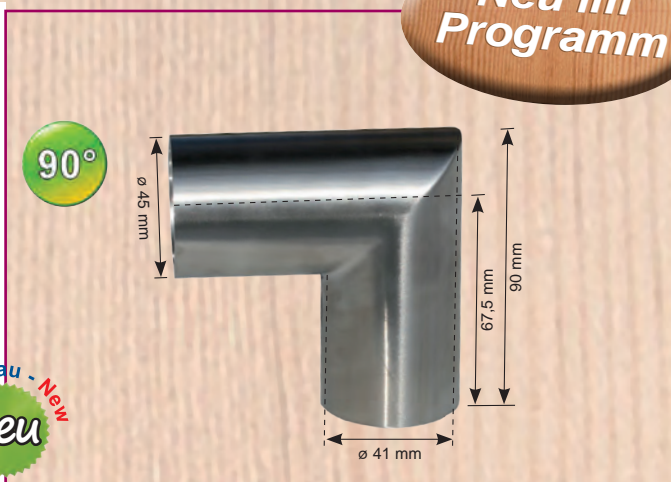

Best.-Nr.	€/ Stk / pcs.
1081	7,49

Nouveau - New
Neu

V2A-Pfostenaufsatz für Holzhandlauf
 Inox Poteaux-Connecteur pour main courante en bois
 Inox Post-Connectors for wood handrail

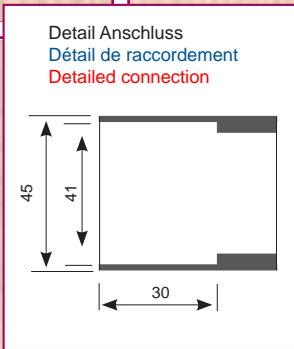
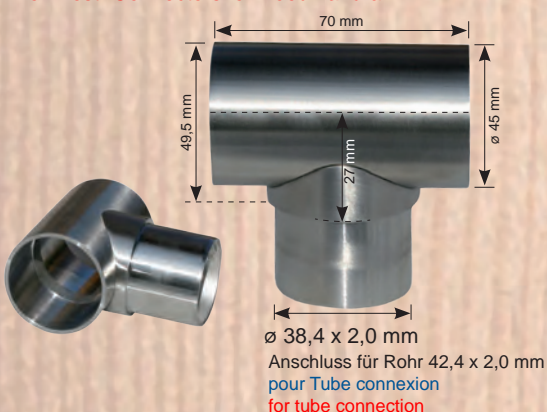

Best.-Nr.	€/ Stk / pcs.
1082	5,99



Best.-Nr.	€/ Stk / pcs.
1083	6,99

Nouveau - New
Neu

V2A-Verbindungsstück für Holzhandlauf
 Inox-Manchon pour main courante en bois
 Inox-Connection piece for wood handrail

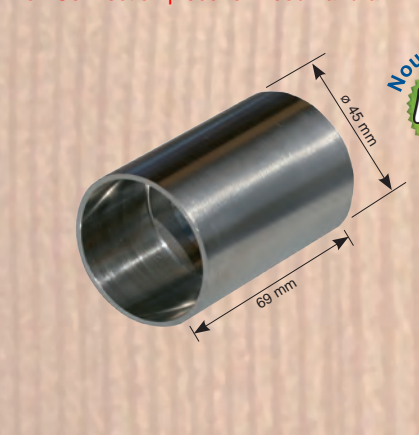

Best.-Nr.	€/ Stk / pcs.
1084	3,99

V2A-Abschluss für Holzhandlauf, flach
 Inox-Achèvement plat pour main courante en bois
 Flat end cap for wood handrail

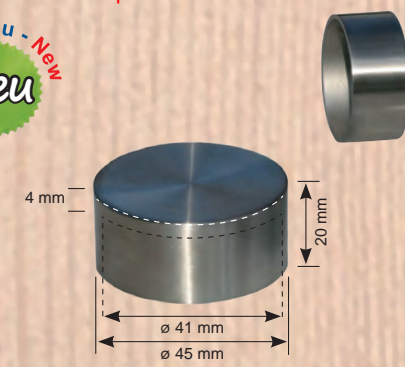

Best.-Nr.	€/ Stk / pcs.
1085	2,99

V2A-Abschluss für Holzhandlauf, flach mit Bohrung
 V2A Achèvement plat pour main courante en bois avec alésage
 Flat end cap for wood handrail with hole

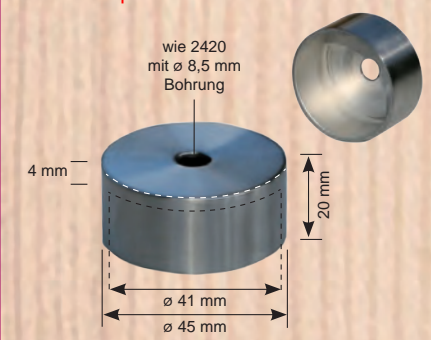

Best.-Nr.	€/ Stk / pcs.
1086	3,49

E-mail: info@akbas-schmiedeeisen.de, www.akbas-schmiedeeisen.de

Tel: +49(0) 61 44 33 05-0, Fax: +49(0) 61 44 33 05-15

Tel: +33.3.68680131, E-mail: vente@akbas-schmiedeeisen.de, Tel: +44.151.6018946, E-mail: sales@akbas-schmiedeeisen.de

AK INOX

Schlossgehäuse und Gegenkästen Boîtiers de serrure et gâches / Locking and striking cases

Schlossgehäuse,
Links oder Rechts verwendbar,
2-tourig
Boîtier en inox,
Disponible droite et gauche,
à 2 tours.
Lock case,
Left or right side usage
with 2-tours lock.

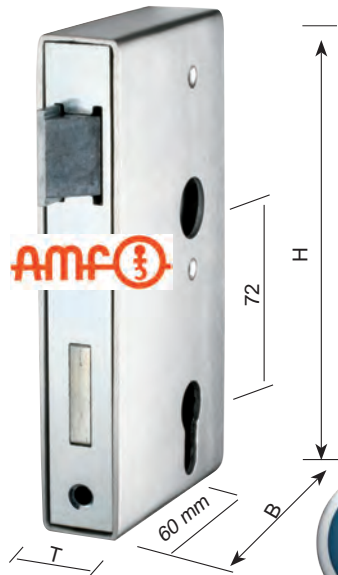

≥ 39,95
€/Stk./pcs.

Dormmaß
60 mm

INOX
304

B x H x T /mm	Best.-Nr.	€/Stk /pcs
96 x 172 x 30	1304-30	39,95
96 x 172 x 34	1304-34	40,95
96 x 172 x 40	1304-40	41,95
96 x 172 x 50	1304-50	47,95

Gegenkasten,
Gehäuse und Schliessblech
Gâche,
Boîtier et platine de gâche
Striking case,
Lock case and striking plate

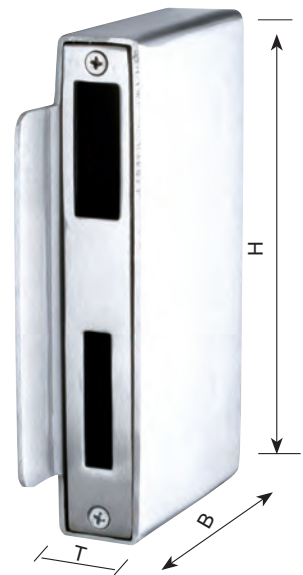

≥ 27,95
€/Stk./pcs.

B x H x T /mm	Best.-Nr.	€/Stk /pcs
96 x 172 x 30	1324-30	27,95
96 x 172 x 34	1324-34	28,95
96 x 172 x 40	1324-40	29,95
96 x 172 x 50	1324-50	32,95

V2A / INOX 304

Schmales Schlossgehäuse,
Links oder Rechts verwendbar,
1-tourig
Boîtier de serrure étroit,
Utilisable droite et gauche,
serrure à un tour
Narrow lock case,
Left or right side usage
with 1-tour lock

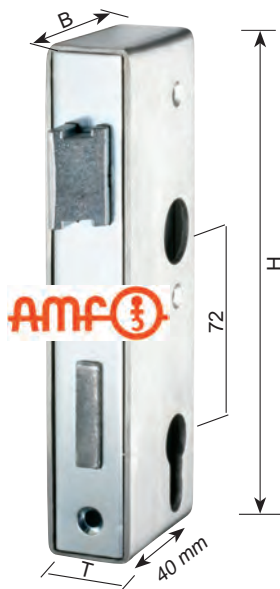

≥ 37,95
€/Stk./pcs.

Dormmaß
40 mm

B x H x T /mm	Best.-Nr.	€/Stk /pcs
60 x 172 x 30	1305	37,95
60 x 172 x 40	1305-40	39,95

Schlossgehäuse
mit Hakenfalle
Boîtier de serrure
à crochet pour porte coulissante
Lock case for sliding doors
with hook



≥ 60,95
€/Stk./pcs.

B x H x T /mm	Best.-Nr.	€/Stk /pcs
96 x 172 x 30	1306-30	60,95
96 x 172 x 34	1306-34	61,95
96 x 172 x 40	1306-40	62,95
96 x 172 x 50	1306-50	64,95

AK INOX

Schlossgehäuse und Gegenkästen Boîtiers de serrure et gâches / Locking and striking cases

Schliesskasten,
links und rechts verwendbar
Gâche à encastrer,
utilisable droite et gauche

Geeignet
für
Elektrischen
Türöffner



≥ 29,95
€/Stk./pcs.

B x H x T /mm	Best.-Nr.	€/Stk /pcs
45 x 172 x 30	1325-30	29,95
45 x 172 x 34	1325-34	30,45
45 x 172 x 40	1325-40	31,95

Schliesskasten,
links und rechts verwendbar
Gâche à encastrer,
utilisable droite et gauche

Geeignet
für
Elektrischen
Türöffner



≥ 29,95
€/Stk./pcs.

B x H x T /mm	Best.-Nr.	€/Stk /pcs
45 x 172 x 30	1326-30	29,95
45 x 172 x 34	1326-34	30,45
45 x 172 x 40	1326-40	31,95

Schliesskasten,
links und rechts verwendbar
Gâche à encastrer,
utilisable droite et gauche

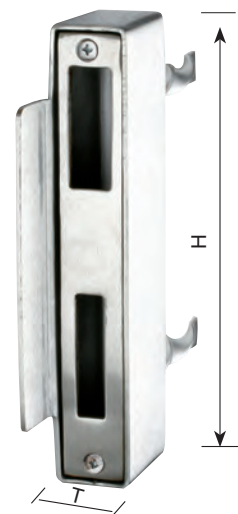

B x H x T /mm	Best.-Nr.	€/Stk /pcs
45 x 172 x 30	1327-30	29,95
45 x 172 x 34	1327-34	30,45
45 x 172 x 40	1327-40	31,95

V2A / Inox 304

Geeignet
für
AMF Schloss-
gehäuse

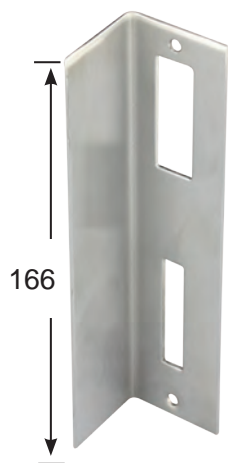

VA-Schliessbleche
Platines de gâche
Striking plates

≥ 5,95
€/Stk./pcs.

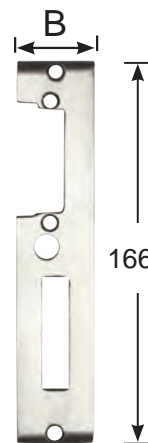

B /mm	Best.-Nr.	€/Stk. /pcs.
30	1350-30	9,95
34	1350-34	9,95
40	1350-40	9,95

Ø /mm	Best.-Nr.	€/Stk. /pcs.
33,7	1351-33	11,95
42,4	1351-42	11,95
48,3	1351-48	11,95

B /mm	Best.-Nr.	€/Stk. /pcs.
24	1352-24	5,95
28	1352-28	5,95
34	1352-34	5,95

B /mm	Best.-Nr.	€/Stk. /pcs.
24	1352E-24	6,95
28	1352E-28	6,95
34	1352E-34	6,95

E-mail: info@akbas-schmiedeeisen.de, www.akbas-schmiedeeisen.de

Tel: +49(0) 61 44 33 05-0, Fax: +49(0) 61 44 33 05-15

Tel: +33.3.68680131, E-mail: vente@akbas-schmiedeeisen.de, Tel: +44.151.6018946, E-mail: sales@akbas-schmiedeeisen.de

AK INOX

Schlossgehäuse und Gegenkästen Boîtiers de serrure et gâches / Locking and striking cases

Design-Schlossgehäuse,
Links oder Rechts verwendbar, 2-tourig
Boîtier de serrure design,
Disponible droite et gauche,
à 2 tours.

Design lock case,
Left or right side usage
with 2-tours lock.

Anschluss "Rund"
Fixation pour barreau
"Round" connection

≥ **72,95**
€/Stk./pcs.



E = 72 mm, A = 60 mm.
mit exaktem verlängerten Ansatz!

Nouveau - New
Neu

øD /mm	B x H x T /mm	Best.-Nr.	€/Stk /pcs
42,4	130 x 250 x 42,4	1301-42	72,95
48,3	130 x 250 x 48,3	1301-48	74,95

Design-Gegenkasten,
Links oder Rechts verwendbar

Gâche design,
Utilisable droite et gauche
Design striking case,
Left or right side usage

Anschluss "rund"
Fixation pour barreau
"Round" connection

≥ **57,95**
€/Stk./pcs.



øD /mm	B x H x T /mm	Best.-Nr.	€/Stk /pcs
42,4	130 x 250 x 42,4	1321-42	57,95
48,3	130 x 250 x 48,3	1321-48	58,95

V2A / INOX 304

Design-Schlossgehäuse,
Links oder Rechts verwendbar, 2-tourig
Boîtier de serrure design,
Disponible droite et gauche, à 2 tours.

Design lock case,
Left or right side usage with 2-tours
lock.

≥ **59,95**
€/Stk./pcs.

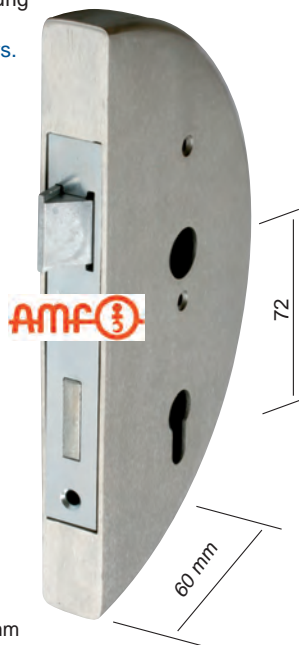

E = 72 mm, A = 60 mm

B x H x T /mm	Best.-Nr.	€/Stk /pcs
130 x 250 x 30	1302-30	59,95
130 x 250 x 34	1302-34	60,95
130 x 250 x 40	1302-40	61,95

Design-Gegenkasten,
Links oder Rechts verwendbar

Gâche design,
Utilisable droite et gauche
Design striking case,
Left or right side usage

≥ **45,95**
€/Stk./pcs.

AK INOX



B x H x T /mm	Best.-Nr.	€/Stk /pcs
130 x 250 x 30	1322-30	45,95
130 x 250 x 34	1322-34	46,95
130 x 250 x 40	1322-40	47,95

AK INOX

Torbänder / Gonds / Hinges

Torbänd mit Anschweißblaschen
2-fach verstellbar, Öffnungswinkel 180°
V2A / Inox 304

Nouveau - New
Neu

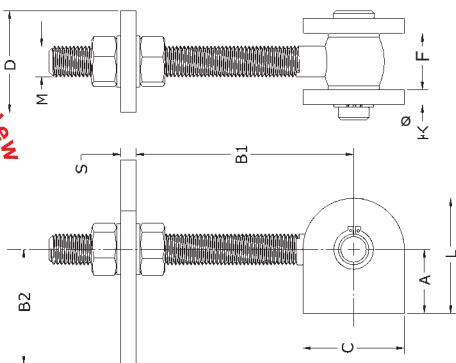

9,49
€/Stk./pcs.

Gewicht /kg	M /mm	F /mm	C x L x A /mm	B1 /mm	B2 /mm	S	D	ø	Best.-Nr.	€/Stk
0,418	M12	19	40 x 45 x 25	40-80	45-60	6	40	12	1390-12-A	9,49

Torbänd verstellbar
V2A / Inox 304

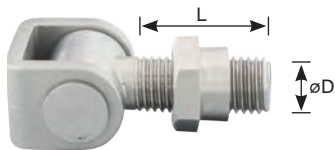

6,49
€/Stk./pcs.

øD /mm	L /mm	Best.-Nr.	€/ Stk / pcs.	
			≤ 9	≥ 10
M12	65	1390-12	6,99	6,49
M12	100	1390-12L	7,49	6,99
M16	65	1390-16	8,49	7,99
M20	65	1390-20	9,99	9,49

Torbänd zweiteilig



4,49
€/Stk./pcs.

øD x L /mm	Best.-Nr.	€/ Stk / pcs.	
		≤ 9	≥ 10
20 x 70	1391-20	4,99	4,49
24 x 85	1391-24	6,99	6,49

Torbänd zweiteilig zur Verschraubung



6,49
€/Stk./pcs.

ø20 mm = M6
ø24 mm = M8

øD x L /mm	Best.-Nr.	€/ Stk / pcs.	
		≤ 9	≥ 10
20 x 70	1392-20	6,99	6,49
24 x 85	1392-24	8,99	8,49

Torriegel für Hangschloss / Verrou au sol pour porte / Door bolt

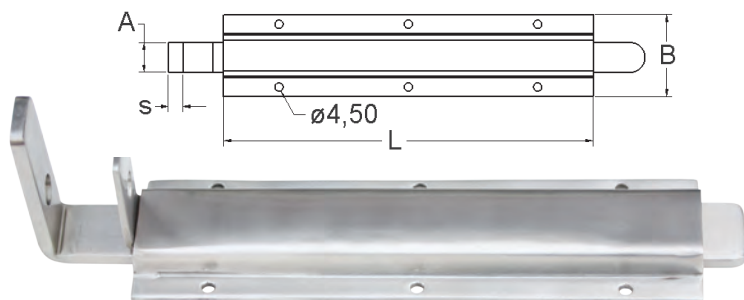

L /mm	B /mm	A /mm	s /mm	Best.-Nr.	€/Stk /pcs
200	55	25	8	1360-200	15,99

Elektrischer Türöffner mit Entriegelung,
Links oder Rechts verwendbar
Gâche électrique avec levier de déblocage.,
Utilisable droite et gauche
Electric door opener with mechanical
release., left or right side usage

6-12V AC/DC,
67 x 16,5 x 28,5 mm
Best.-Nr. 10270

24,95
€/Stk./pcs.



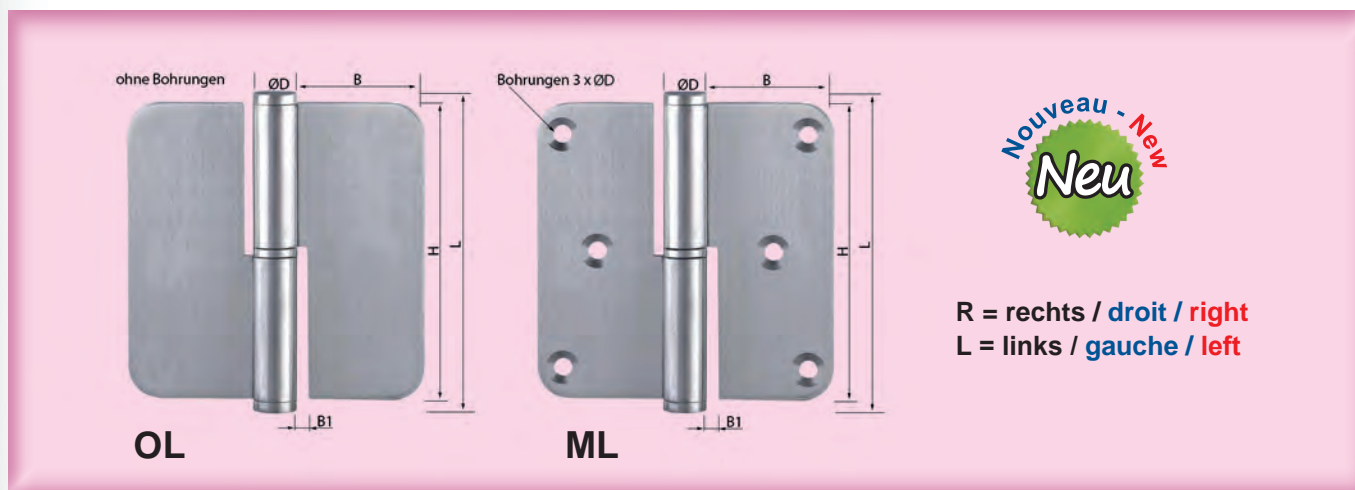

R = rechts / droit / right
L = links / gauche / left

V2A / INOX 304

12,99
€/Stk./pcs.



RF =
RÜCKFEDERUNG
Bohrungen angesenkt!

élastique
Springback
Les trous fraisés!
Countersunk holes!

B / mm	B1 / mm	H / mm	L / mm	øD / mm	s / mm	Bohrung / mm	Best.-Nr.	€ / Stk / pcs.
32	3	180	192	18	3	4 x Ø5,5	1387-180-ML-RF	12,99
32	3	180	192	18	3	ohne Loch	1387-180-OL-RF	12,99

7,29
€/Stk./pcs.



RF =
RÜCKFEDERUNG
Bohrungen angesenkt!

élastique
Springback
Les trous fraisés!
Countersunk holes!

B / mm	B1 / mm	H / mm	L / mm	øD / mm	s / mm	Bohrung / mm	Best.-Nr.	€ / Stk / pcs.
43	2	103	103	18	3	4 x Ø7	1389-100-ML-RF	7,29
43	2	103	103	18	3	ohne Loch	1389-100-OL-RF	7,29

≥ **9,19**
€/Stk./pcs.



RF =
RÜCKFEDERUNG
Bohrungen angesenkt!

Élastique
Springback
Les trous fraisés!
Countersunk holes!

B / mm	B1 / mm	H / mm	L / mm	øD / mm	s / mm	Bohrung / mm	Best.-Nr.	€ / Stk / pcs.
35	3	100	112	18	3	4 x Ø5,5	1388-100-ML-RF	9,19
35	3	100	112	18	3	ohne Loch	1388-100-OL-RF	9,19
35	3	120	132	18	3	4 x Ø5,5	1388-120-ML-RF	9,99
35	3	120	132	18	3	ohne Loch	1388-120-OL-RF	9,99

≥ **2,29**
€/Stk./pcs.

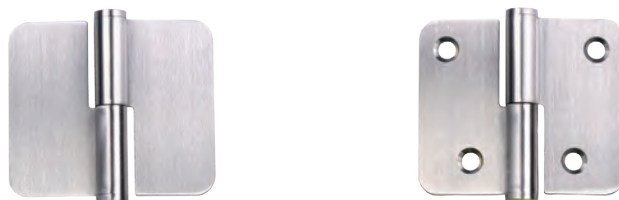

Bohrungen
angesenkt!

Les trous fraisés!
Countersunk holes!

B / mm	B1 / mm	H / mm	L / mm	øD / mm	s / mm	Bohrung / mm	Best.-Nr.	€ / Stk / pcs.
32	2	60	65	12	2	2 x Ø6	1395-60-MLR	2,49
32	2	60	65	12	2	2 x Ø6	1395-60-MLL	2,49
32	2	60	65	12	2	ohne Loch	1395-60-OLR	2,29
32	2	60	65	12	2	ohne Loch	1395-60-OLL	2,29

≥ **2,99**
€/Stk./pcs.

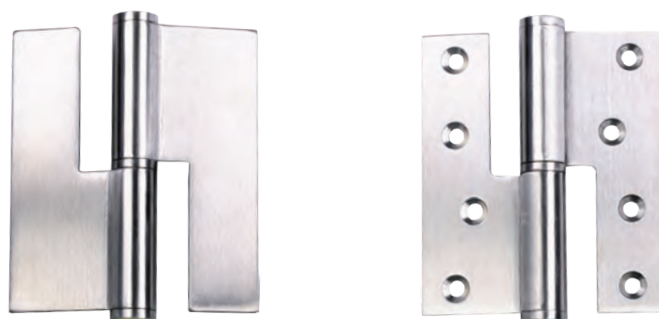

Bohrungen
angesenkt!

Les trous fraisés!
Countersunk holes!

B / mm	B1 / mm	H / mm	L / mm	øD / mm	s / mm	Bohrung / mm	Best.-Nr.	€ / Stk / pcs.
23	6	76	81	12	2,5	6 x Ø5	1394-76-MLR	3,29
23	6	76	81	12	2,5	6 x Ø5	1394-76-MLL	3,29
23	6	76	81	12	2,5	ohne Loch	1394-76-OLR	2,99
23	6	76	81	12	2,5	ohne Loch	1394-76-OLL	2,99
35	11	100	106	16	3	8 x Ø5,4	1394-100-MLR	5,29
35	11	100	106	16	3	8 x Ø5,4	1394-100-MLL	5,29
35	11	100	106	16	3	ohne Loch	1394-100-OLR	4,99
35	11	100	106	16	3	ohne Loch	1394-100-OLL	4,99

E-mail: info@akbas-schmiedeeisen.de, www.akbas-schmiedeeisen.de

Tel: +49(0) 61 44 33 05-0, Fax: +49(0) 61 44 33 05-15

Tel: +33.3.68680131, E-mail: vente@akbas-schmiedeeisen.de, Tel: +44.151.6018946, E-mail: sales@akbas-schmiedeeisen.de

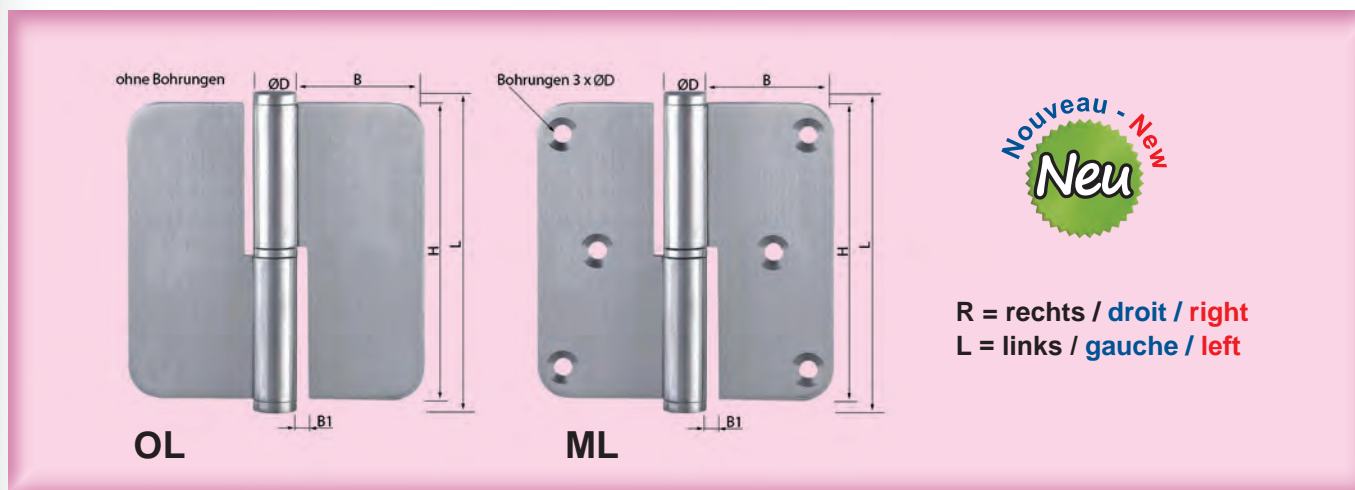

B / mm	B1 / mm	H / mm	L / mm	ØD / mm	s / mm	Bohrung / mm	Best.-Nr.	€ / Stk / pcs.
27	3	76	82	12	2,5	3 x Ø5,5	1399-76-ML	2,79
27	3	76	82	12	2,5	ohne Loch	1399-76-OL	2,79



B / mm	B1 / mm	H / mm	L / mm	ØD / mm	s / mm	Bohrung / mm	Best.-Nr.	€ / Stk / pcs.
38	0	102	108	12	2,5	4 x Ø6	1398-100-MLR	3,19
38	0	102	108	12	2,5	4 x Ø6	1398-100-MLL	3,19
38	0	102	108	12	2,5	ohne Loch	1398-100-OLR	3,19
38	0	102	108	1	2,5	ohne Loch	1398-100-OLL	3,19
40	0	127	133	18	3	5 x Ø7	1398-125-ML	6,29
40	0	127	133	18	3	ohne Loch	1398-125-OL	6,29

V2A / INOX 304

≥
5,19
€/Stk./pcs.

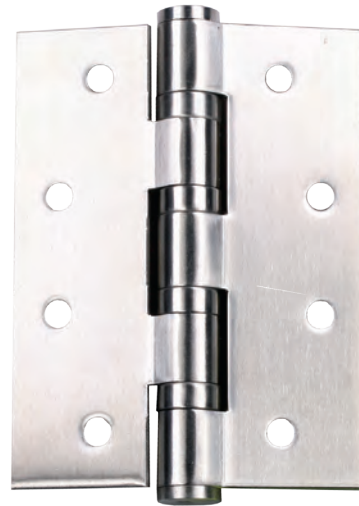
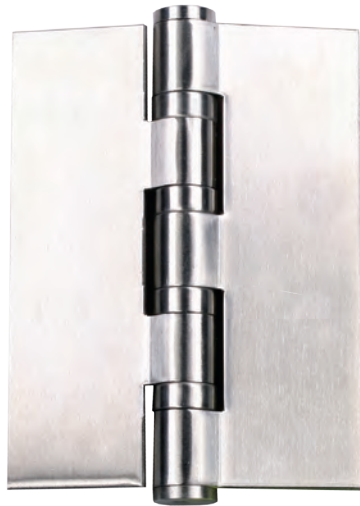

Bohrungen
angesenkt!

Les trous fraisés!
Countersunk holes!

B / mm	H / mm	L / mm	øD / mm	s / mm	Bohrung / mm	Best.-Nr.	€/ Stk / pcs.
30	102	108	14	3	8 x Ø5,7	1393-100-ML	5,49
30	102	108	14	3	ohne Loch	1393-100-OL	5,19
30	128	134	14	3	10 x Ø5,7	1393-130-ML	6,99
30	128	134	14	3	ohne Loch	1393-130-OL	6,99
42	152	158	14	3	10 x Ø5,7	1393-160-ML	8,99
42	152	158	14	3	ohne Loch	1393-160-OL	8,99

≥
4,69
€/Stk./pcs.



Bohrungen
angesenkt!

Les trous fraisés!
Countersunk holes!

B / mm	H / mm	L / mm	øD / mm	s / mm	Bohrung / mm	Best.-Nr.	€/ Stk / pcs.
39	89	95	12	2,5	6 x Ø5	1396-89-MLR	4,99
39	89	95	12	2,5	6 x Ø5	1396-89-MLL	4,99
39	89	95	12	2,5	ohne Loch	1396-89-OLR	4,69
39	89	95	12	2,5	ohne Loch	1396-89-OLL	4,69
34	120	126	14	3	8 x Ø5	1396-120-MLR	6,79
34	120	126	14	3	8 x Ø5	1396-120-MLL	6,79
34	120	126	14	3	ohne Loch	1396-120-OLR	6,49
34	120	126	14	3	ohne Loch	1396-120-OLL	6,49
34	140	146	16	3	8 x Ø6	1396-140-MLR	7,99
34	140	146	16	3	8 x Ø6	1396-140-MLL	7,99
34	140	146	16	3	ohne Loch	1396-140-OLR	7,69
34	140	146	16	3	ohne Loch	1396-140-OLL	7,69

E-mail: info@akbas-schmiedeeisen.de, www.akbas-schmiedeeisen.de

Tel: +49(0) 61 44 33 05-0, Fax: +49(0) 61 44 33 05-15

Tel: +33.3.68680131, E-mail: vente@akbas-schmiedeeisen.de, Tel: +44.151.6018946, E-mail: sales@akbas-schmiedeeisen.de

AK INOX

Türdrücker - Hohl Poignées de porte - Creuses / Lever handles - Hollow



140 x 60 mm
Best.-Nr. 1700



140 x 60 mm
Best.-Nr. 1701

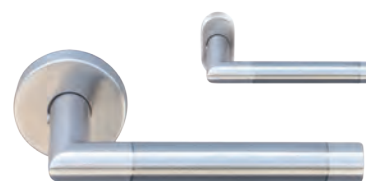

140 x 60 mm
Best.-Nr. 1701-SH



140 x 60 mm
Best.-Nr. 1702



140 x 60 mm
Best.-Nr. 1703



140 x 60 mm
Best.-Nr. 1704

Kartoninhalt

Zwei Türgriffe
Zwei Drücker-Rosetten
Zwei Schlüssel-Rosetten
Schrauben
Vierkantstift (8x100 mm)



Contenu d'une boîte

Deux poignées
Deux rosettes de poignée
Deux rosettes de serrure
Vis
Branche quadrangulaire

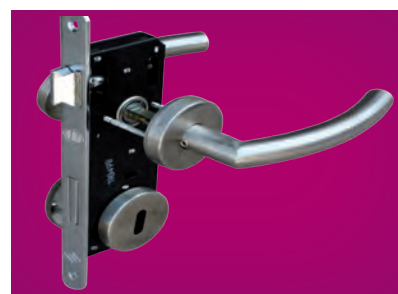

140 x 60 mm
Best.-Nr. 1707



140 x 60 mm
Best.-Nr. 1712



140 x 60 mm
Best.-Nr. 1713



140 x 60 mm
Best.-Nr. 1714



140 x 60 mm
Best.-Nr. 1715



140 x 60 mm
Best.-Nr. 1716

AK INOX

Türdrücker - Massiv Poignées de porte - Pleines / Lever handles - Solid



19,95 €/Satz/Set

140 x 60 mm
Best.-Nr. 1707



19,95 €/Satz/Set

140 x 60 mm
Best.-Nr. 1708



24,95 €/Satz/Set

140 x 60 mm
Best.-Nr. 1709

V2A / INOX 304

140 x 60 mm
Best.-Nr. 1700-OR

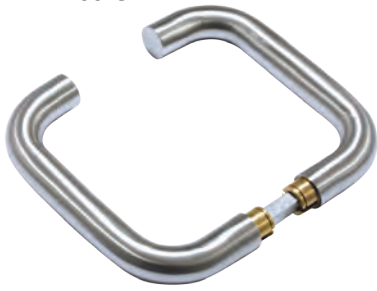

Nouveau - New
Neu

4,49
€/Stk./pcs.

140 x 60 mm
Best.-Nr. 1701-OR

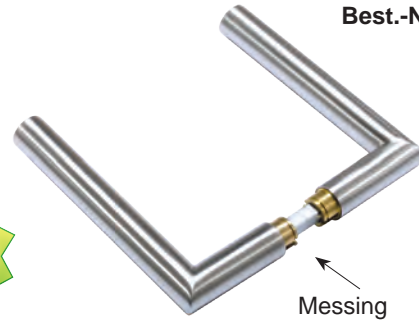

Messing



140 x 60 mm
Best.-Nr. 1703-OR

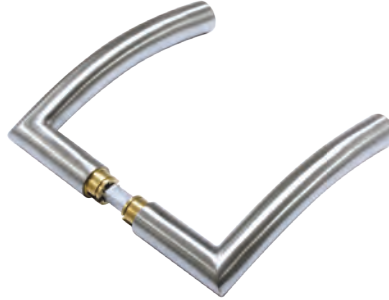

140 x 60 mm
Best.-Nr. 1704-OR

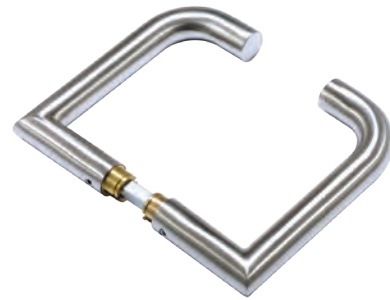

140 x 60 mm
Best.-Nr. 1716-OR



Best.-Nr.
1704-LS-WC
17,95 €/Satz./Set.



Best.-Nr.
1703-LS-WC
17,95 €/Satz./Set.

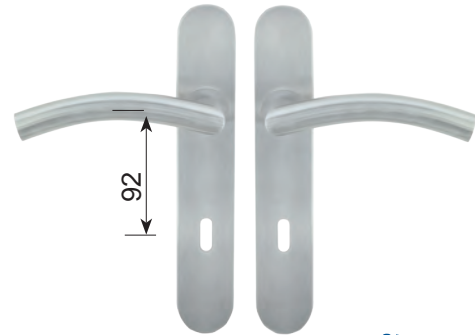

LS = 220 x 40 mm

Best.-Nr.
1704-LS
15,95 €/Satz./Set.

Nouveau - New
Neu

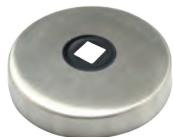

ø 55 mm
Best.-Nr.
1750-FU
2,49
€/Stk./pcs



ø 55 mm
Best.-Nr.
1750-PZ
1,49
€/Stk./pcs



ø 55 mm
Best.-Nr.
1750-BB
1,49
€/Stk./pcs



ø 55 mm
Best.-Nr.
1750-B
1,49
€/Stk./pcs



26 x 65 mm
Best.-Nr.
1755-FU
2,49
€/Stk./pcs



26 x 65 mm
Best.-Nr.
1755-PZ
1,49
€/Stk./pcs



26 x 65 mm
Best.-Nr.
1755-BB
1,49
€/Stk./pcs



26 x 65 mm
Best.-Nr.
1755-B
1,49
€/Stk./pcs

E-mail: info@akbas-schmiedeeisen.de, www.akbas-schmiedeeisen.de

Tel: +49(0) 61 44 33 05-0, Fax: +49(0) 61 44 33 05-15

Tel: +33.3.68680131, E-mail: vente@akbas-schmiedeeisen.de, Tel: +44.151.6018946, E-mail: sales@akbas-schmiedeeisen.de

AK INOX

Türknöpfe / Poignées / Lever handles

Kartoninhalt

- 1 x Türgriff
- 1 x Drücker-Rosette
- 1 x Schlüssel-Rosette
- Schrauben
- Vierkantstift (8x100 mm)

F = Fest / Fix / Fix
D = Drehbar / Rotative / Turnable

≥ 15,95
€/Stk./pcs.



Best.-Nr.	€/Stk./pcs
1724- F	15,95
1724- D	17,95

Alle auch mit
OVAL ROSETTEN
erhältlich

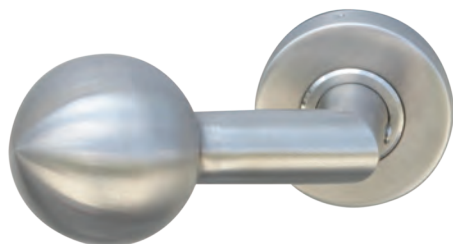

Best.-Nr.	€/Stk./pcs
1725- F	16,95
1725- D	17,95

Contenu d'une boîte

- 1x poignées
- 1x rosettes de poignée
- 1x rosettes de serrure
- Vis
- Branche quadrangulaire



Best.-Nr.	€/Stk./pcs
1727- F	16,95
1727- D	17,95



Best.-Nr.	€/Stk./pcs
1728- F	16,95
1728- D	17,95

Paar/Set

Massiv / Pleines / Solid
Drehbar / Pivotante Turnable



24,95
€/Paar/Set



87 x 37 x 37 mm

Best.-Nr.
1711



Best.-Nr.	€/Stk./pcs
1729- F	16,95
1729- D	17,95

V2A / INOX 304

Fest / Fixe / Fixed

Best.-Nr.
1720

19,95 €/Stk./pcs.

Drehbar / Pivotante / Turnable

Best.-Nr.
1721

21,95 €/Stk./pcs.

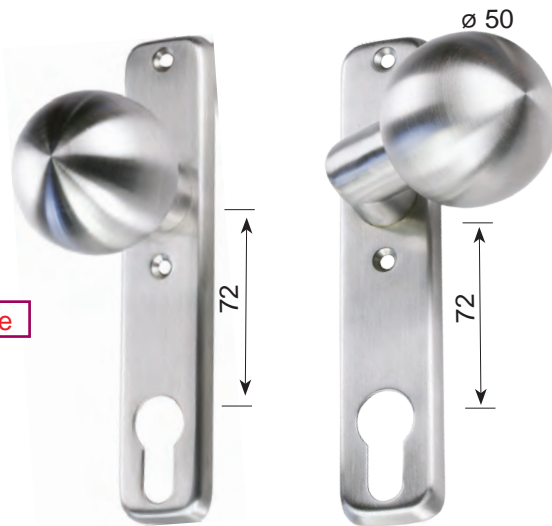

Fest / Fixe / Fixed

Best.-Nr.

1722R Rechts /a droite /right
1722L Links /a gauche /left

19,95 €/Stk./pcs.

Drehbar / Pivotante / Turnable

Best.-Nr.
1723

21,95 €/Stk./pcs.

≥ 19,95 €/Stk./pcs.

Nouveau - New
Neu

F = Fest / Fix / Fix
D = Drehbar / Rotative / Turnable



Best.-Nr.	€/Stk./pcs
1730- KR-F	19,95
1730- KR-D	21,95



Best.-Nr.	€/Stk./pcs
1731- KR-F	19,95
1731- KR-D	21,95

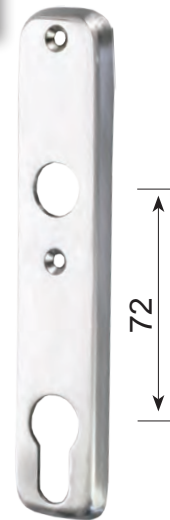

Best.-Nr. 1756
6,99 €/Stk./pcs.



Best.-Nr.	€/Stk./pcs
1732- KR-F	19,95
1732- KR-D	21,95

Geeignet für AMF Schlossgehäuse



Best.-Nr.	€/Stk./pcs
1733- KR-F	19,95
1733- KR-D	21,95

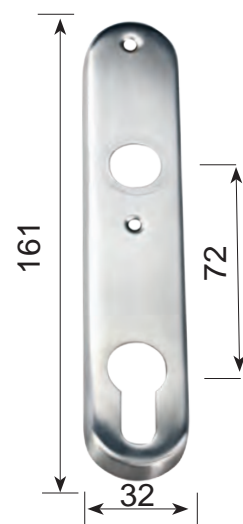

Best.-Nr. 1756-KR
6,99 €/Stk./pcs.

V2A / INOX 304



Best.-Nr.
1740-KR
17,95 €/Stk./pcs.

Nouveau - New
Neu



Best.-Nr.
1741-KR
17,95 €/Stk./pcs.

Nouveau - New
Neu

Geeignet
für
AMF Schloss-
gehäuse



Best.-Nr.
1742-KR
17,95 €/Stk./pcs.

Nouveau - New
Neu



Best.-Nr.
1743-KR
17,95 €/Stk./pcs.

Nouveau - New
Neu

Geeignet
für
AMF Schloss-
gehäuse



Best.-Nr.
1700-KS
17,95 €/Stk./pcs.

Nouveau - New
Neu



Best.-Nr.
1701-KS
17,95 €/Stk./pcs.

Nouveau - New
Neu

17,95
€/Stk./pcs.

Nouveau - New
Neu



Länge / mm = L	Bohrungsabstand / mm = B	Ansatz	Best.-Nr.	€ / Stk / pcs.
300	210		1770-300	19,95
300	210	45°	1770-300-45	27,95
350	210		1770-350	20,95
350	210	45°	1770-350-45	28,95
400	300		1770-400	21,95
400	300	45°	1770-400-45	29,95
500	300		1770-500	26,95
500	300	45°	1770-500-45	34,95
600	400		1770-600	29,95
600	400	45°	1770-600-45	37,95
800	400		1770-800	34,95
800	400	45°	1770-800-45	42,95
1000	700		1770-1000	39,95
1000	700	45°	1770-1000-45	47,95
1200	900		1770-1200	44,95
1200	900	45°	1770-1200-45	52,95
1600	1300		1770-1600	54,95
1600	1300	45°	1770-1600-45	62,95
1800	1500		1770-1800	59,95
1800	1500	45°	1770-1800-45	67,95
2000	1800		1770-2000	69,95
2000	1800	45°	1770-2000-45	79,95

inkl.

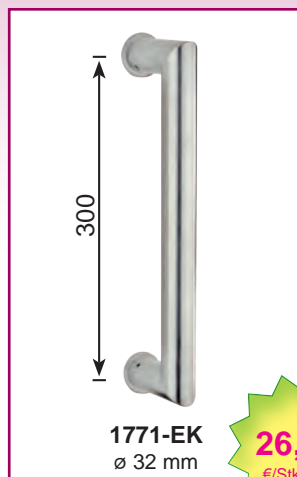
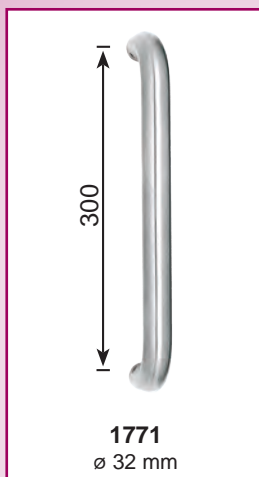

26,95
€/Stk./pcs.

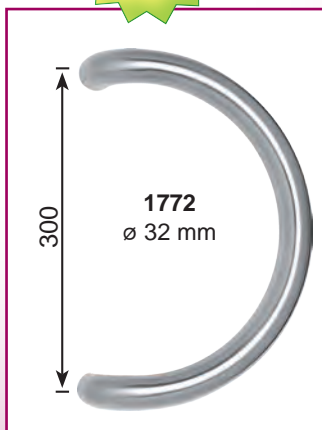
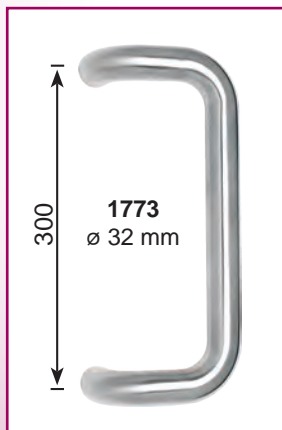
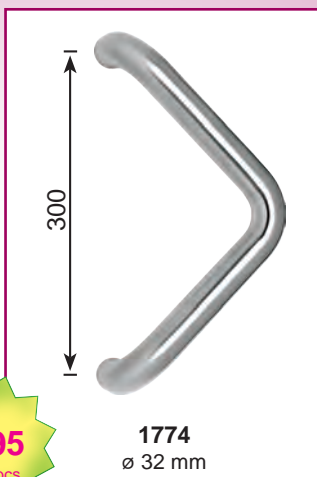

0 1 2 3
4 5 6
7 8 9
a b c d

0,1,2,3,4,5,6,7,8,9
= 150 mm
a,b,c,d = 115 mm
Best.-Nr.
1790

7,95
€/Stk./pcs.



Akhas

Schmiedeeisen & Metallwaren

Länge / Longueur / Length
ca. 900 mm

Stab / Barreau / Baluster
ø 12 mm

AK INOX

Designstäbe / Barreaux design / Design bars

V2A / INOX 304

10,99

€/Stk./ pcs



Best.-Nr.
1500

40 x 40 mm

13,99

€/Stk./ pcs



Best.-Nr.
1501

40 x 600 mm

9,99

€/Stk./ pcs



Best.-Nr.
1523

30 x 70 mm

12,99

€/Stk./ pcs



Best.-Nr.
1523-D

30 x 600 mm

9,99

€/Stk./ pcs



Best.-Nr.
1524

30 x 70 mm

12,99

€/Stk./ pcs



Best.-Nr.
1524-D

30 x 600 mm

19,99

€/Stk./ pcs



Best.-Nr.
1503

105 x 600 mm

15,99

€/Stk./ pcs



Best.-Nr.
1502

55 x 900 mm

29,99

€/Stk./ pcs



Best.-Nr.
1507

125 x 460 mm

19,99

€/Stk./ pcs



Best.-Nr.
1506

125 x 460 mm

29,99

€/Stk./ pcs



Best.-Nr.
1514

125 x 700 mm

29,99

€/Stk./ pcs



Best.-Nr.
1515

125 x 700 mm

56

Lieferung ab 129,- € Frei Haus

(Lieferung innerhalb Deutschland zzgl. Inselzuschlag. Ausgenommen Stangenware ab 1500 mm und Chemikalien.)



AK INOX

Designstäbe / Barreaux design / Design bars

29,99

€/Stk./ pcs



Best.-Nr.
1521

125 x 355 mm

29,99

€/Stk./ pcs



Best.-Nr.
1522

110 x 430 mm

34,99

€/Stk./ pcs

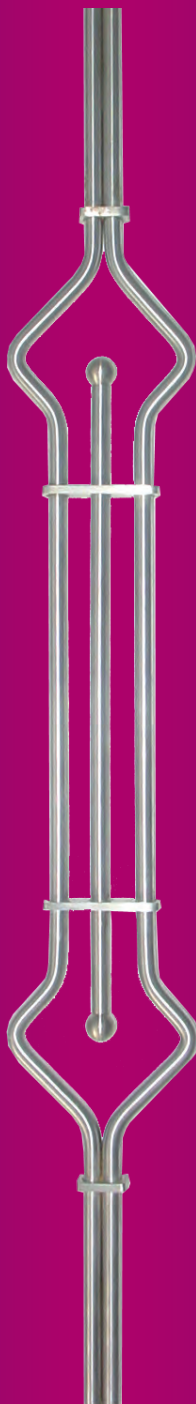

Best.-Nr.
1508

130 x 540 mm

34,99

€/Stk./ pcs

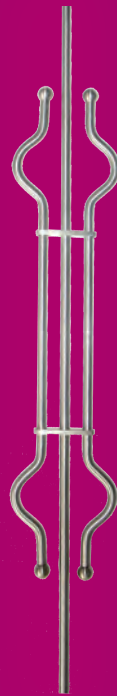

Best.-Nr.
1516

140 x 600 mm

34,99

€/Stk./ pcs

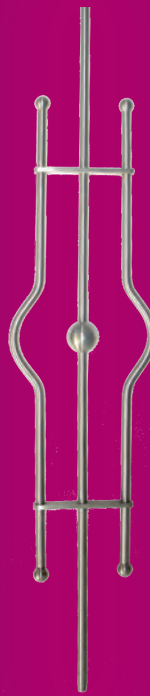

Best.-Nr.
1519

190 x 600 mm

19,99

€/Stk./ pcs



Best.-Nr.
1525

190 x 600 mm

29,99

€/Stk./ pcs

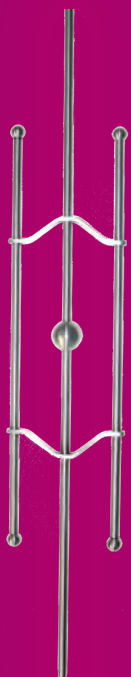

Best.-Nr.
1512

150 x 550 mm

39,99

€/Stk./ pcs

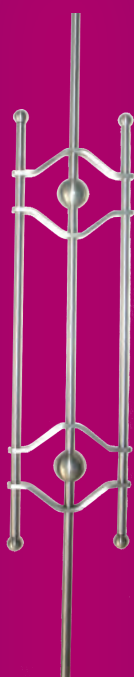

Best.-Nr.
1513

150 x 550 mm

Oval - Ringe

Anneau oval

Oval ring

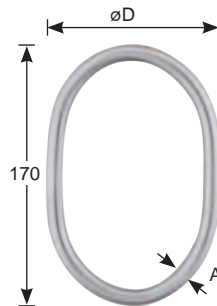

≥ **6,99**

€/Stk./pcs.

øD /mm	A /mm	Best.-Nr.	€/ Stk /pcs.
100	12	1581-100-12	6,99
110	12	1581-110-12	7,49
120	12	1581-120-12	7,99

Ringe

Anneau

Ring

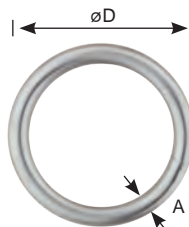

Nouveau - New
Neu

≥ **4,99**

€/Stk./pcs.

øD /mm	A /mm	Best.-Nr.	€/ Stk /pcs.
100	12	1580-100-12	4,99
110	12	1580-110-12	5,49
120	12	1580-120-12	5,99

E-mail: info@akbas-schmiedeeisen.de, www.akbas-schmiedeeisen.de

Tel: +49(0) 61 44 33 05-0, Fax: +49(0) 61 44 33 05-15

Tel: +33.3.68680131, E-mail: vente@akbas-schmiedeeisen.de, Tel: +44.151.6018946, E-mail: sales@akbas-schmiedeeisen.de

AK INOX

Edelstahl-Rohre
Tubes en acier inoxydable / Stainless steel pipes



AK INOX

42,4 x 2,0 mm

≥ 4,79 €/m

Korn 320 geschliffen

Werkstoff	Länge / m	∅ /mm	Best.-Nr.	€/m.
1.4301	6	∅ 26,9 x 2,0	1400-26-2	auf Anfrage
1.4301	6	∅ 33,7 x 2,0	1400-33-2	auf Anfrage
1.4301	6	∅ 42,4 x 2,0	1400-42-2	auf Anfrage
1.4301	6	∅ 48,3 x 2,0	1400-48-2	auf Anfrage
1.4301	6	□ 30 x 30 x 2,0	1400-3030-2	auf Anfrage
1.4301	6	□ 40 x 40 x 2,0	1400-4040-2	auf Anfrage

6 m Stangenmaterial-Verkauf nur ab Lager Bischofsheim.

Lieferung und andere Abmessungen auf Anfrage !

Angegebene Preise gelten nur bis zum 15.5.2014

AK INOX

Edelstahl-Stabmaterial
Tubes en acier inoxydable / Stainless steel pipes



∅ 12 mm

≥ 2,69 €/m

Korn 320 geschliffen

Werkstoff	Länge / m	mm	Best.-Nr.	€/m.
1.4301	6	● 10	1400-10	auf Anfrage
1.4301	6	● 12	1400-12	auf Anfrage
1.4301	6	■ 25x5	1400-25-5	auf Anfrage
1.4301	6	■ 25x8	1400-25-8	auf Anfrage
1.4301	6	■ 40x5	1400-40-5	auf Anfrage
1.4301	6	■ 40x8	1400-40-8	auf Anfrage



V2A / INOX 304

Drahtseile / Cordages / Wire ropes

≥ **16,50**
€/Stk./pcs.

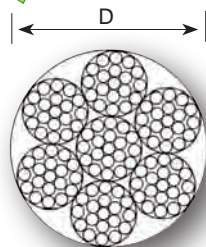

Drahtseil 7x19, 25 m-Rolle
Cordage 7x19, 25 m-Bobine
Wire rope 7x19, 25 m-Reel

V2A / Inox 304		
øD /mm	Best.-Nr.	€/Stk /pcs
3	1420-3-S 304	16,50
4	1420-4-S 304	29,50
5	1420-5-S 304	39,50

Ketten / Chaines / Chains



Edelstahl V2A
Inox 304 Inox 304
DIN 766

≥ **1,99**
€/Stk./pcs.

V2A / Inox 304		
øD /mm	Best.-Nr.	€/m
3	1421-3-304	1,99
4	1421-4-304	3,69
5	1421-5-304	5,99
6	1421-6-304	8,79



≥ **2,19**
€/Stk./pcs.

Rechtsgewinde
Filetage droite
Right thread

øD /mm	øD1 /mm	L /mm	M x l /mm	Best.-Nr.	€/Stk /pcs
2	7,85	50	4x20	1461-8	2,19
3	9,7	56	4x20	1461-10	2,99
4	12	65	5x24	1461-12	3,19

Linksgewinde
Filetage gauche
Left thread

øD /mm	øD1 /mm	L /mm	M x l /mm	Best.-Nr.	€/Stk /pcs
2	7,85	50	4x20	1461-8-L	2,19
3	9,7	56	4x20	1461-10-L	2,99
4	12	65	5x24	1461-12-L	3,19

Gewindeterminale für Selbstmontage
Embout à filetage externe
Self mounting terminal with external thread

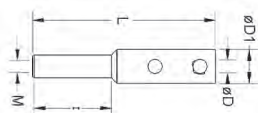

≥ **2,49**
€/Stk./pcs.

Rechtsgewinde
Filetage droite
Right thread

øD /mm	øD1 /mm	L /mm	M x l /mm	Best.-Nr.	€/Stk /pcs
2	8	50	4x20	1460-2	2,49
3	10	56	4x20	1460-3	3,29
4	12	65	5x25	1460-4	3,99

Linksgewinde
Filetage gauche
Left thread

øD /mm	øD1 /mm	L /mm	M x l /mm	Best.-Nr.	€/Stk /pcs
2	8	50	4x20	1460-2-L	2,49
3	10	56	4x20	1460-3-L	3,29
4	12	65	5x25	1460-4-L	3,99

Drahtseilhalter
Fixation de Corde
Rope fix

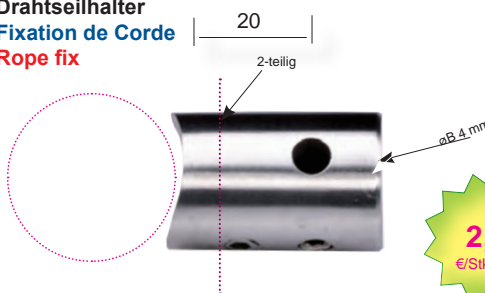

≥ **2,49**
€/Stk./pcs.

øD /mm	øB /mm	Best.-Nr.	€/Stk /pcs
flach	4	1970-G-4	2,49
33,7	4	1970-33-4	2,49
42,4	4	1970-42-4	2,49

Augeterminale für Selbstmontage
Embout à chape, fixation interne
Self mounting fork terminal

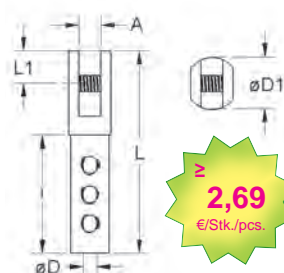

≥ **2,69**
€/Stk./pcs.

øD /mm	øD1 /mm	L /mm	l /mm	L1 /mm	A /mm	Best.-Nr.	€/Stk /pcs
2	10	44	24,5	7,0	4,7	1433-S-2	2,69
3	12	57	32,0	7,5	5,0	1433-S-3	3,49
4	16	60	35,0	8,0	7,0	1433-S-4	4,19

Gabelterminale für Selbstmontage
Embout à chape avec oeil
Self mounting terminal with eye

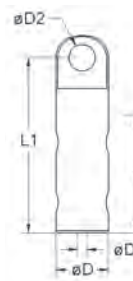



≥ **2,49**
€/Stk./pcs.

øD /mm	øD1 /mm	øD2 /mm	L1 /mm	l /mm	Best.-Nr.	€/Stk /pcs
2	2,4	4,5	37	25	1430-S-2	2,49
3	3,5	5,5	43	32	1430-S-3	2,99
4	4,5	6,5	52	34	1430-S-4	3,49

AK INOX

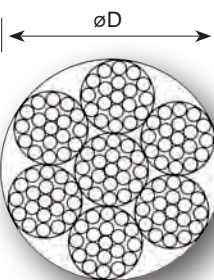
Drahtseile und Zubehör Cordages acier et équipements / Wire rope and accessories

 Drahtseil 7x19, 25 m-Rolle
 Cordage 7x19, 25 m-Bobine
 Wire rope 7x19, 25 m-Reel



V4A / Inox 316			
øD /mm	Best.-Nr.	€/Stk / pcs.	
3	3420-3	19,50	
4	3420-4	34,50	
5	3420-5	44,50	

Drahtseilschere für Stahl und Edelstahl
 Coupeur de fil de corde
 Wire Rope Cutter







Schneidleistung 12 mm
 Länge 500 mm
 Gewicht 1500 gramm

Best.-Nr.310-400

Spannhülse
 Cage fermée de ridoir / Body of turnbuckle





M	Best.-Nr.	€/Stk / pcs
M5	3425-5	1,99
M6	3425-6	2,29
M8	3425-8	3,85
M10	3425-10	6,19

Gewindeösenterminal
 Boulon à oeil / Eye bolt





M	Best.-Nr.	€/Stk / pcs
M5	3437-5	1,15
M6	3437-6	1,49
M8	3437-8	2,49
M10	3437-10	3,45

Spansschloss mit Haken-Öse
 Ridoir à crochet-oeil / Turnbuckle with Hook-Eye





L /mm	M	Best.-Nr.	€/Stk / pcs
172-252	M6	3418-HE-6	3,99
182-257	M8	3418-HE-8	6,85
213-298	M10	3418-HE-10	11,19
238-318	M12	3418-HE-12	19,65

Augenschraube
 Piton à oeil / Eye bolt



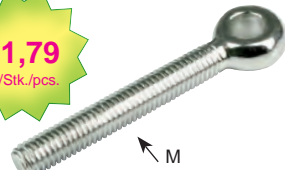

M	Best.-Nr.	€/Stk / pcs
M6	3491-2-6	1,79
M8	3491-2-8	3,49
M10	3491-2-10	4,55

Spansschloss mit Haken/Haken
 Ridoir à deux crochets / Turnbuckle with Hook-Hook





L /mm	M	Best.-Nr.	€/Stk / pcs
160	M6	3418-HH-6	3,99
200	M8	3418-HH-8	6,85
240	M10	3418-HH-10	11,19
300	M12	3418-HH-12	19,65

Spansschloss mit Öse/Öse
 Ridoir à deux yeux / Turnbuckle with Eye-Eye





L /mm	M	Best.-Nr.	€/Stk / pcs
160	M6	3418-EE-6	3,99
200	M8	3418-EE-8	6,85
240	M10	3418-EE-10	11,19
300	M12	3418-EE-12	19,65

Wantenspanner mit 2 Gabeln
 Ridoir à chapes fixes / Turnbuckle with two forks





L /mm	M	Best.-Nr.	€/Stk / pcs
144	M6	3423-6	5,45
173	M8	3423-8	9,35
207	M10	3423-10	14,79
251	M12	3423-12	27,25

Augbolzen
 Boulon à oeil avec écrou / Eye bolt with cap



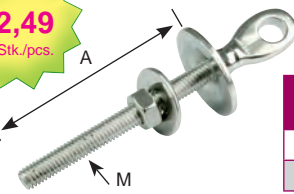

M	A /mm	Best.-Nr.	€/Stk / pcs
M6	60	3438-6	2,49
M8	80	3438-8	3,79

Augenschraube mit Holzgewinde
 Piton à oeil fermé filetage bois
 Eye bolt with wood thread



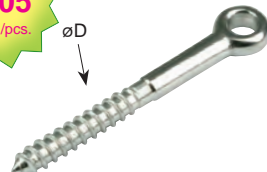

øD /mm	Best.-Nr.	€/Stk / pcs
M6	3491-1-6	1,05
M8	3491-1-8	1,79
M10	3491-1-10	2,99

Gewindegabel
 Embout à chape avec filetage externe / Fork with external thread





øD /mm	Best.-Nr.	€/Stk / pcs
M5	3434-5	2,19
M6	3434-6	3,95
M8	3434-8	9,25
M10	3434-10	10,69

V4A / INOX 316

Gewindegabel
Embout à chape avec filetage externe / Fork with external thread

≥ 1,69
€/Stk./pcs.

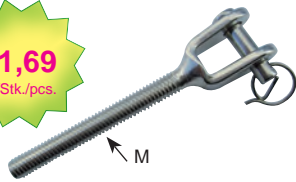

M	Best.-Nr.	€/Stk./pcs
M5	3432-5	1,69
M6	3432-6	3,39
M8	3432-8	8,69
M10	3432-10	9,99

Augterminal für Selbstmontage
Embout à chape, fixation interne / Self mounting fork terminal

≥ 2,35
€/Stk./pcs.



øD /mm	Best.-Nr.	€/Stk./pcs
2	3433-S-2	2,35
3	3433-S-3	3,19
4	3433-S-4	3,59

Augterminal
Embout à oeil à sertir / Eye bolt terminal

≥ 1,75
€/Stk./pcs.



øD /mm	Best.-Nr.	€/Stk./pcs
3	3436-3	1,75
4	3436-4	2,29
5	3436-5	3,79
6	3436-6	6,69

Gewindeterminal
Piton à sertir / Swage stud

≥ 1,89
€/Stk./pcs.



M	øD /mm	Best.-Nr.	€/Stk./pcs
M6	3	3439-6-3	1,89
M6	4	3439-6-4	1,95
M8	5	3439-8-5	3,39
M10	6	3439-10-6	6,15

Linsenkopfterminal
Terminaison à tête cylindrique bombée à sertir / Domed head terminal

≥ 0,89
€/Stk./pcs.



øD /mm	Best.-Nr.	€/Stk./pcs
3	3440-3	0,89
4	3440-4	1,09
5	3440-5	1,29
6	3440-6	1,79

Gabelterminal
Embout à chape / Fork terminal

≥ 1,99
€/Stk./pcs.



øD /mm	Best.-Nr.	€/Stk./pcs
3	3431-3	1,99
4	3431-4	2,59
5	3431-5	3,75
6	3431-6	7,29

Wantenspanner mit Gabel/Gewinde
Ridoir à chape fixe, terminaison à sertir
Turnbuckle with fork and terminal

≥ 5,59
€/Stk./pcs.



M	øD /mm	Best.-Nr.	€/Stk./pcs
M6	3	3424-6	5,59
M8	4	3424-8	9,19
M10	5	3424-10	13,99
M12	6	3424-12	26,49

Gabelterminal
Embout à chape / Fork terminal

≥ 4,95
€/Stk./pcs.



øD /mm	Best.-Nr.	€/Stk./pcs
3	3433-3	4,95
4	3433-4	6,85
5	3433-5	12,35
6	3433-6	19,35

Pressklemme
Manchon / Ferrule

øD /mm	Best.-Nr.	€/Stk./pcs
3	3442-3	0,99
4	3442-4	1,29
5	3442-5	2,69
6	3442-6	3,49

Eiform-Klemme
Serre cable / Wire clamp

øD /mm	Best.-Nr.	€/Stk./pcs
3	3443-3	3,99
4	3443-4	4,29
5	3443-5	5,49
6	3443-6	6,49

Nouveau - New
Neu

Winkelausgleich 35°
Connecteur / Connecting fitting

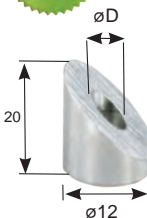

øD	Best.-Nr.	€/Stk./pcs
4,5	3462-4	1,29
5,5	3462-5	1,29
6,5	3462-6	1,39
8,5	3462-8	1,39

≥ 1,29
€/Stk./pcs.

Hydraulische Presszange CYO-430
Profi-Werkzeug, einfach in der Bedienung!



249,95
Euro

Best.-Nr.310-430

siehe Detail Seite 130

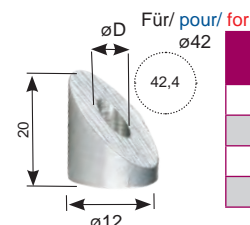

øD	Für Rohr ø/mm	Best.-Nr.	€/Stk
4,5	42,4	3462-4-42	1,29
5,5	42,4	3462-5-42	1,29
6,5	42,4	3462-6-42	1,39
8,5	42,4	3462-8-42	1,39

Gabelterminal für Selbstmontage
Embout à chape avec oeil
Self mounting terminal with eye

≥ 5,35
€/Stk./pcs.



øD /mm	Best.-Nr.	€/Stk /pcs
2	3435-4	5,35
3	3435-5	5,69
4	3435-6	6,79
5	3435-8	13,69
6	3435-10	23,89

Innengewindeterminale für Selbstmontage
Embout à filetage interne
Self mounting terminal with internal thread

≥ 2,79
€/Stk./pcs.



M	øD /mm	Best.-Nr.	€/Stk /pcs
M4	2	3460-2	2,79
M4	3	3460-3	3,75
M5	4	3460-4	4,65

Gewindeterminale für Selbstmontage
Embout à filetage externe
Self mounting terminal with external thread

≥ 2,39
€/Stk./pcs.



øD /mm	Best.-Nr.	€/Stk /pcs
2	3461-8	2,39
3	3461-10	3,25
4	3461-12	3,39

Gabelterminal für Selbstmontage
Embout à chape avec oeil
Self mounting terminal with eye

≥ 3,35
€/Stk./pcs.



øD /mm	Best.-Nr.	€/Stk /pcs
2	3430-S-2	3,35
3	3430-S-3	4,39
4	3430-S-4	4,59

Gabelterminal für Selbstmontage
Embout à chape avec oeil
Self mounting terminal with eye

≥ 5,35
€/Stk./pcs.



øD /mm	Best.-Nr.	€/Stk /pcs
2	3451-4	5,35
3	3451-5	5,69
4	3451-6	6,79
5	3451-8	13,69
6	3451-10	23,89

Gabelterminal für Selbstmontage
Embout à chape avec oeil
Self mounting terminal with eye

≥ 5,35
€/Stk./pcs.



øD /mm	Best.-Nr.	€/Stk /pcs
2	3450-4	5,35
3	3450-5	5,69
4	3450-6	6,79
5	3450-8	13,69
6	3450-10	23,89

AK INOX

Ketten und Zubehör Chaînes et équipements / Chains and accessories

Edelstahl V4A
Inox 316 / Inox 316
DIN 766



øD /mm	Best.-Nr.	€/ m
3	3421-3	2,27
4	3421-4	3,98
5	3421-5	6,24
6	3421-6	9,06

Stahl verzinkt
Acier zingué / Galvanized steel
DIN 766



øD /mm	Best.-Nr.	€/ m
3	1421-Z-3	0,49
4	1421-Z-4	0,59
5	1421-Z-5	0,79
6	1421-Z-6	1,29

Schäkel
Manille droite / Shackle (D type)

≥ 0,95
€/Stk./pcs.



øD /mm	Best.-Nr.	€/Stk /pcs
4	3401-4	0,95
5	3401-5	1,10
6	3401-6	1,32
8	3401-8	2,43

Schäkel
Manille droite / Shackle (D type)

≥ 0,94
€/Stk./pcs.



øD /mm	Best.-Nr.	€/Stk /pcs
4	3410-4	0,94
5	3410-5	1,19
6	3410-6	1,99
8	3410-8	2,92

Schäkel
Manille droite / Shackle (D type)

≥ 0,99
€/Stk./pcs.



øD /mm	Best.-Nr.	€/Stk /pcs
4	3402-4	0,99
5	3402-5	1,15
6	3402-6	1,40
8	3402-8	2,55

Schäkel
Manille droite / Shackle (D type)

≥ 1,38
€/Stk./pcs.



øD /mm	Best.-Nr.	€/Stk /pcs
5	3411-5	1,38
6	3411-6	2,18
8	3411-8	3,65

Schäkel
Manille droite / Shackle (D type)

≥ 1,16
€/Stk./pcs.



øD /mm	Best.-Nr.	€/Stk /pcs
4	3403-4	1,16
5	3403-5	1,39
6	3403-6	1,82
8	3403-8	3,68

Schäkel
Manille lyre / Shackle (omega type)

≥ 1,54
€/Stk./pcs.



øD /mm	Best.-Nr.	€/Stk /pcs
5	3412-5	1,54
6	3412-6	2,01
8	3412-8	3,20

AK INOX

Ketten und Zubehör Chaînes et équipements / Chains and accessories

≥ 1,16 €/Stk./pcs.

Schäkel
Manille lyre / Shackle (omega type)



øD /mm	Best.-Nr.	€/Stk /pcs
4	3404-4	1,16
5	3404-5	1,39
6	3404-6	1,82
8	3404-8	3,68

≥ 1,57 €/Stk./pcs.

Schäkel
Manille droite / Shackle (D type)



øD /mm	Best.-Nr.	€/Stk /pcs
6	3414-6	1,57
8	3414-8	2,14

≥ 0,92 €/Stk./pcs.

Schäkel
Manille droite / Shackle (D type)



øD /mm	Best.-Nr.	€/Stk /pcs
4	3409-4	0,92
5	3409-5	1,03
6	3409-6	1,41
8	3409-8	2,82

≥ 0,91 €/Stk./pcs.

Augenschraube mit Ring
Piton à anneau / Eye bolt with ring



A /mm	Best.-Nr.	€/Stk /pcs
3	3492-3	0,91
5	3492-5	1,66

≥ 1,50 €/Stk./pcs.

Ringmutter
Ecroû à anneau / Lifting eye nut



M	Best.-Nr.	€/Stk /pcs
M6	3489-6	1,50
M8	3489-8	2,04
M10	3489-10	3,64

≥ 0,24 €/Stk./pcs.

Seilkausche
Cosse coeur / Wire thimble



øD /mm	Best.-Nr.	€/Stk /pcs
3	3455-3	0,24
4	3455-4	0,28
5	3455-5	0,33
6	3455-6	0,36

≥ 1,46 €/Stk./pcs.

Ringschraube
Vis à anneau / Lifting eye bolt



M	Best.-Nr.	€/Stk /pcs
M6	3490-6	1,46
M8	3490-8	2,23
M10	3490-10	4,03

≥ 0,36 €/Stk./pcs.

Simplexklemme
Serre câble plat / Simplex wire rope clip



øD /mm	Best.-Nr.	€/Stk /pcs
3	3448-3	0,36
4	3448-4	0,58
5	3448-5	0,78
6	3448-6	1,32

≥ 1,10 €/Stk./pcs.

Kettenschnellverschluss
Crochet avec écrou / Hook with nut



øD /mm	Best.-Nr.	€/Stk /pcs
4	3482-4	1,10
5	3482-5	1,40
6	3482-6	1,94
8	3482-8	3,75

≥ 0,67 €/Stk./pcs.

Duplexklemme
Double serre câble plat / Duplex wire rope clips



øD /mm	Best.-Nr.	€/Stk /pcs
3	3449-3	0,67
4	3449-4	1,07
5	3449-5	1,46
6	3449-6	2,46

≥ 0,79 €/Stk./pcs.

Karabinerhaken
Mousqueton / Snap hook



D x L /mm	Best.-Nr.	€/Stk /pcs
4 x 40	3465-4	0,79
5 x 50	3465-5	0,97
6 x 60	3465-6	1,26
8 x 80	3465-8	2,43

≥ 0,83 €/Stk./pcs.

Seilklemme
Serre câble à étrier / Wire rope clip



øD /mm	Best.-Nr.	€/Stk /pcs
3	3441-3	0,83
4	3441-4	0,91
5	3441-5	1,08
6	3441-6	1,27

E-mail: info@akbas-schmiedeeisen.de, www.akbas-schmiedeeisen.de

Tel: +49(0) 61 44 33 05-0, Fax: +49(0) 61 44 33 05-15

Tel: +33.3.68680131, E-mail: vente@akbas-schmiedeeisen.de, Tel: +44.151.6018946, E-mail: sales@akbas-schmiedeeisen.de

AK INOX

Nouveau - New
Neu

Steckfittings / Raccords / Tube fittings

Kleber auftragen und einstecken, fertig !!
Appliquez de la colle et insert, fini !!
Apply glue and insert, finished !!

Top  **90°**

≥ 6,29
€/Stk./pcs.

Rohr Tube /mm	Best.-Nr.	€/Stk /pcs
33,7 x 2,0	3911-33	6,29
42,4 x 2,0	3911-42	7,49

Top  **90°**

53

≥ 7,49
€/Stk./pcs.

Rohr Tube /mm	Best.-Nr.	€/Stk /pcs
33,7 x 2,0	3910-33	7,49
42,4 x 2,0	3910-42	8,49

 **≥ 8,49**
€/Stk./pcs.

Rohr Tube /mm	Best.-Nr.	€/Stk /pcs
33,7 x 2,0	3919-33	8,49
42,4 x 2,0	3919-42	9,99

V4A / INOX 316

 **≥ 3,79**
€/Stk./pcs.

Rohr Tube /mm	Best.-Nr.	€/Stk /pcs
33,7 x 2,0	3916-33	3,79
42,4 x 2,0	3916-42	4,19

90° Schweißbogen
Coude
Elbow **90°**

≥ 3,19
€/Stk./pcs.

Poliert
Poli
Polished

øD x s /mm	Rm	Best.-Nr	€ / Stk / pcs.
33,7 x 2,0	35	3924-33	3,19
42,4 x 2,0	44	3924-42	3,49

Top  **≥ 3,79**
€/Stk./pcs.

Rohr Tube /mm	Best.-Nr.	€/Stk /pcs
33,7 x 2,0	3917-33	3,79
42,4 x 2,0	3917-42	4,19

V4A / INOX 316

Nouveau - New
Neu

V4A / INOX 316

Wandbefestigung Articles de fixation / Side mounted bases

 **17,49**
€/Stk./pcs.

ø11
40 mm
ø100x6

Rohr/Tube /mm	Best.-Nr.	€ / Stk / pcs.
42,4	3960-42	17,49

 **18,79**
€/Stk./pcs.

ø11
150x60x6
øB

øB /mm	Best.-Nr.	€ / Stk / pcs.
43	3963-42	18,79

 **18,79**
€/Stk./pcs.

øB
ø11
ø100x6

øB /mm	Best.-Nr.	€ / Stk / pcs.
42,4	3964-42	18,79

AK INOX

Rohrabschluss / Embout de fermeture / End cap

Nouveau - New
Neu

Rohrabschlussstopfen, gewölbt
Embout de fermeture, Bombé
End cap, Cambered

≥ 2,29
€/Stk./pcs.



øD x s /mm	Best.-Nr.	€/ Stk / pcs.	
		≤ 99	≥ 100
26,9 x 2,0	3004	2,39	2,29
33,7 x 2,0	3001	2,49	2,29
42,4 x 2,0	3002	2,59	2,39
48,3 x 2,0	3003	3,29	2,99

gewölbt mit M8 Gewinde

≥ 3,49
€/Stk./pcs.



øD x s /mm	Best.-Nr.	€/ Stk / pcs.	
		≤ 99	≥ 100
26,9 x 2,0	3004-G	3,59	3,49
33,7 x 2,0	3001-G	3,69	3,49
42,4 x 2,0	3002-G	3,79	3,59
48,3 x 2,0	3003-G	4,79	4,49

Rohr-Abschlusskugeln
Embout sphérique
Sphere end cap

Kleber auftragen und einstecken, fertig !!
Appliquez de la colle et insert, fini !!
Apply glue and insert, finished !!

≥ 6,59
€/Stk./pcs.



øB /mm	øD /mm	Best.- Nr.	€/ Stk / p cs.
33,7	45	3051	6,59
42,4	55	3052	7,79



≥ 3,29
€/Stk./pcs.

Länge x Breite / mm	Best.-Nr.	€/ Stk / pcs.
20 x 30	3070-2030	3,29
30 x 30	3070-3030	3,59
30 x 40	3070-3040	3,89
30 x 50	3070-3050	4,19
40 x 40	3070-4040	4,19
40 x 60	3070-4060	4,99

Hohlkugeln / Sphères / Spheres

Hohlkugeln
Sphères
Spheres



≥ 4,39
€/Stk./pcs.

øD /mm	Best.-Nr.	€/ Stk / pcs.	
		≤ 49	≥ 50
40	3603	4,79	4,39
50	3604	6,09	5,59
60	3605	8,09	7,59
70	3606	9,99	9,49
80	3607	11,19	10,69
90	3608	17,39	16,79
100	3609	18,79	17,79

Hohlkugeln, mit Gewinde
Sphères, avec pas de vis
Spheres, with screw hole



≥ 4,39
€/Stk./pcs.

øD /mm	M	Best.-Nr.	€/ Stk / pcs.	
			≤ 49	≥ 50
40	M8	3603-G	4,79	4,39
50	M8	3604-G	7,49	6,99
60	M8	3605-G	8,69	8,19
70	M8	3606-G	11,09	10,59
80	M10	3607-G	11,99	11,49
90	M10	3608-G	17,49	16,99
100	M10	3609-G	19,29	18,29

E-mail: info@akbas-schmiedeeisen.de, www.akbas-schmiedeeisen.de

Tel: +49(0) 61 44 33 05-0, Fax: +49(0) 61 44 33 05-15

Tel: +33.3.68680131, E-mail: vente@akbas-schmiedeeisen.de, Tel: +44.151.6018946, E-mail: sales@akbas-schmiedeeisen.de

Handlaufhalter mit 2 Bohrungen
Auslieferung ohne Befestigungsschrauben



≥ **4,99**
€/Stk./pcs.

2 x Ø9 mm
gesenkt
Ø70 x 4 mm

Best.-Nr.	€/ Stk / pcs.	≤ 99	≥ 100
3220	5,59	4,99	

Handlaufhalter mit 3 Bohrungen
Auslieferung ohne Befestigungsschrauben



3 x Ø6,5 mm
gesenkt
Ø64 x 4 mm

Best.-Nr.	€/ Stk / pcs.	≤ 99	≥ 100
3240	5,59	4,99	

≥ **4,99**
€/Stk./pcs.

V4A / INOX 316

Querstabhalter mit Doppelbohrung
Support transversal percé, deux trous
Bar holder with double hole



≥ **4,99**
€/Stk./pcs.

ØB /mm	Best.-Nr.	€/ Stk / pcs.	≤ 99	≥ 100
12,2 - 12,2	3976-1212	5,29	4,99	

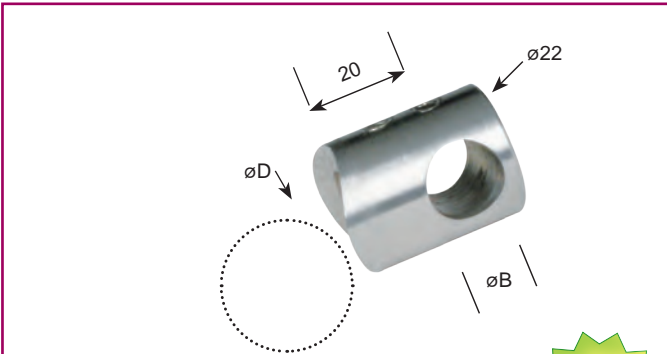

ØD /mm	ØB /mm	Best.-Nr.	€/ Stk / pcs.	≤ 99	≥ 100
42,4	12,2	3970-4212	2,99	2,59	

≥ **2,59**
€/Stk./pcs.

V4A / INOX 316

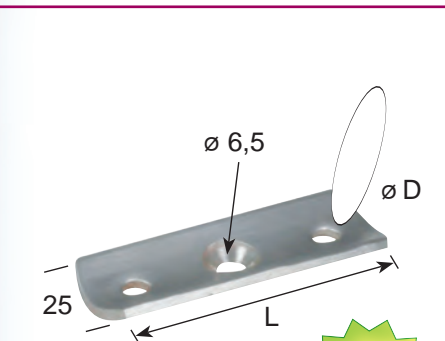

≥ **1,59**
€/Stk./pcs.

ØD /mm	L /mm	Best.-Nr.	Code	€/ Stk / pcs.	≤ 99	≥ 100
33,7	65	3280		1,69	1,59	
42,4	65	3281		1,69	1,59	
48,3	65	3282		1,69	1,59	

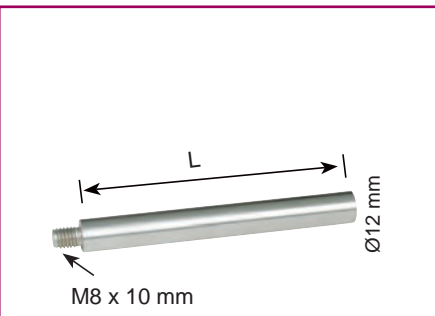

≥ **1,89**
€/Stk./pcs.

L /mm	Best.-Nr.	€/ Stk / pcs.	≤ 99	≥ 100
65	3290	1,99	1,89	
100	3291	2,09	1,99	
120	3296	2,19	2,09	

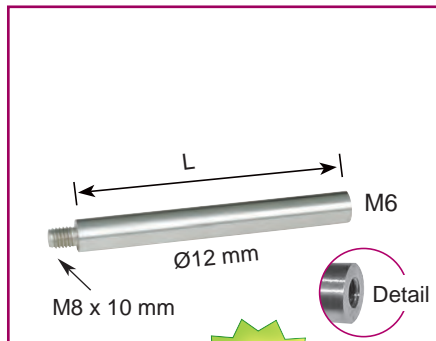

≥ **2,29**
€/Stk./pcs.

L /mm	Best.-Nr.	€/ Stk / pcs.	≤ 99	≥ 100
65	3292	2,39	2,29	
100	3293	2,49	2,39	
120	3297	2,69	2,59	

V4A / INOX 316

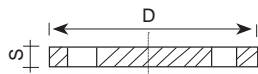

Alle Ronden mit
„plus Service“
Kanten bearbeitet!

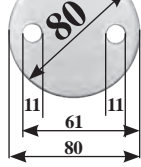

≥ 2,49
€/Stk./pcs.

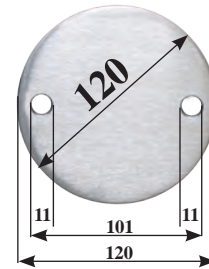
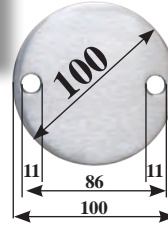

Best.-Nr. 3120 Best.-Nr. 3121 Best.-Nr. 3122

D x s /mm	Best.-Nr.	€/ Stk / pcs. ≤ 99	≥ 100
70 x 4	3120	2,69	2,49
70 x 6	3121	3,09	2,89
80 x 6	3122	3,59	3,39

Top

D x s /mm	Best.-Nr.	€/ Stk / pcs. ≤ 79	≥ 80
100 x 6	3123	4,99	4,69

D x s /mm	Best.-Nr.	€/ Stk / pcs. ≤ 49	≥ 50
120 x 6	3124	6,99	6,59



D x s /mm	Best.-Nr.	€/ Stk / pcs. ≤ 99	≥ 100
42 x 4	3101	0,89	0,79
80 x 4	3106	2,79	2,69
80 x 6	3107	3,19	3,09

D x s /mm	Best.-Nr.	€/ Stk / pcs. ≤ 79	≥ 80
100 x 6	3109	5,29	4,99

D x s /mm	Best.-Nr.	€/ Stk / pcs. ≤ 49	≥ 50
120 x 6	3110	7,09	6,89

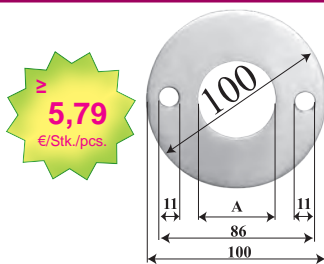

D x s /mm	A /mm	Best.-Nr.	€/ Stk / pcs. ≤ 79	≥ 80
100 x 6	43	3132-43	6,19	5,79

Schale gewölbt, ungeschliffen
Embout bombé, non poli
Domed cap, unpolished



Material 2,0 mm

∅ /mm	h	Zoll	Best.-Nr.	€/ Stk / pcs. ≤ 99	≥ 100
27	7	3/4	3200-27	0,45	0,40
33	8	1	3200-33	0,55	0,49
42	9	1 1/4	3200-42	0,66	0,61
48	10	1 1/2	3200-48	0,74	0,69

Nouveau - New - Nuovo
Neu

V4A / INOX 316

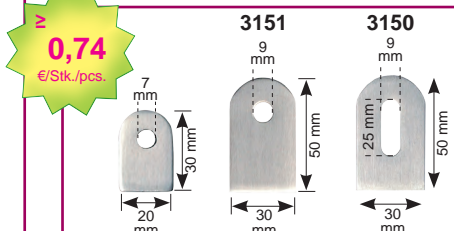

B x H x s /mm	Best.-Nr.	€/ Stk / pcs. ≤ 99	≥ 100
50 x 30 x 4	3150	0,99	0,94
50 x 30 x 4	3151	0,99	0,94
30 x 20 x 4	3152	0,79	0,74



B x H x s /mm	Best.-Nr.	€/ Stk / pcs. ≤ 79	≥ 80
120x80x6	3142	5,29	4,89

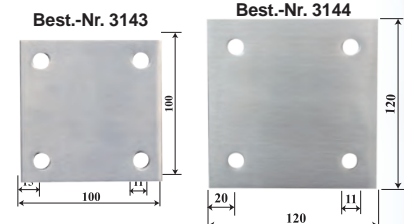

B x H x s /mm	Best.-Nr.	€/ Stk / pcs. ≤ 64	≥ 65
100x100x6	3143	5,79	5,49
120x120x6	3144	7,69	7,39

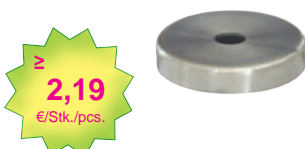

∅B /mm	Best.-Nr.	€/ Stk / pcs. ≤ 49	≥ 50
75	3206-12	2,49	2,19



∅B /mm	Best.-Nr.	€/ Stk / pcs. ≤ 49	≥ 50
105	3216-43	4,99	4,69

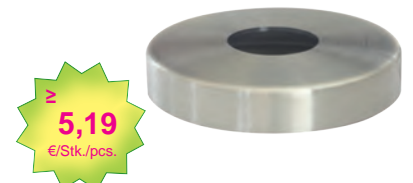

∅B /mm	Best.-Nr.	€/ Stk / pcs. ≤ 49	≥ 50
125	3217-43	5,59	5,19

AK INOX

Klemmbefestigungen Pince de vitre / Glass clamp

INOX Form 1

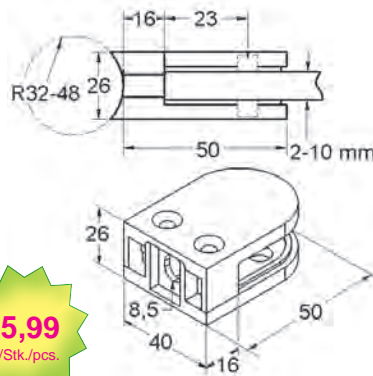

≥ **5,99**
€/Stk./pcs.

Für Flach (G) Profil plat Flat back	Für Rund (R) Profil incurvé Curved back	Für Glas Epaisseur de vitre Glass thickness
---	---	---

00	ø 32, 42, 48 mm	2-10 mm
----	-----------------	---------

	R /mm	Best.-Nr.	€/ Stk / pcs.	
			≤ 99	≥ 100
V4A / Inox 316	00	1840-G	6,49	5,99
	32	1840-R32	6,49	5,99
	42	1840-R42	6,49	5,99
	48	1840-R48	6,49	5,99

INOX Form 2

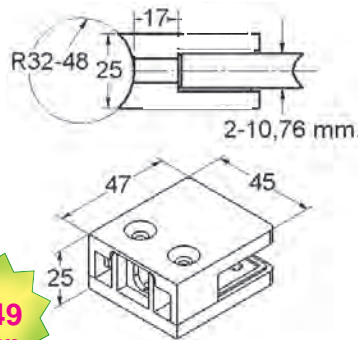

≥ **6,49**
€/Stk./pcs.

Für Flach (G) Profil plat Flat back	Für Rund (R) Profil incurvé Curved back	Für Glas Epaisseur de vitre Glass thickness
---	---	---

00	ø 32, 42, 48 mm	2-10,76 mm
----	-----------------	------------

	R /mm	Best.-Nr.	€/ Stk / pcs.	
			≤ 99	≥ 100
V4A / Inox 316	00	1850-G	6,89	6,49
	32	1850-R32	6,89	6,49
	42	1850-R42	6,89	6,49
	48	1850-R48	6,89	6,49

INOX Form 3

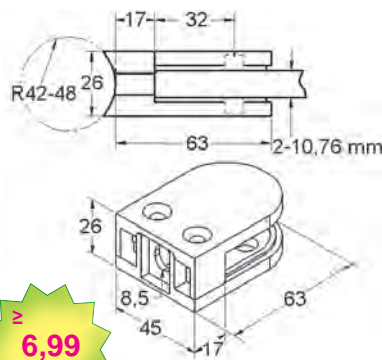

≥ **6,99**
€/Stk./pcs.

Für Flach (G) Profil plat Flat back	Für Rund (R) Profil incurvé Curved back	Für Glas Epaisseur de vitre Glass thickness
---	---	---

00	ø 32, 42, 48 mm	2-10,76 mm
----	-----------------	------------

	R /mm	Best.-Nr.	€/ Stk / pcs.	
			≤ 99	≥ 100
V4A / Inox 316	00	1860-G	7,49	6,99
	32	1860-R32	7,49	6,99
	42	1860-R42	7,49	6,99
	48	1860-R48	7,49	6,99

INOX Form 8

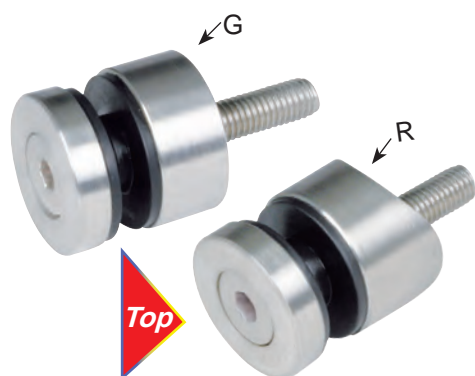

≥ **4,49**
€/Stk./pcs.

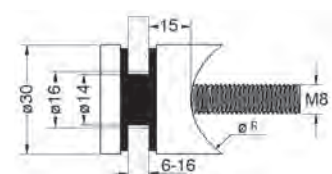
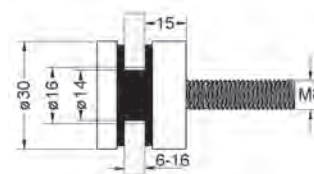

	R /mm	Best.-Nr.	€/ Stk / pcs.	
			≤ 99	≥ 100
V4A / Inox 316	00	1870-G	4,99	4,49
	32	1870-R32	4,99	4,49
	42	1870-R42	4,99	4,49
	48	1870-R48	4,99	4,49

V4A / INOX 316

Für Flach (G) Profil plat Flat back
Für Rund (R) Profil incurvé Curved back
Für Glas Epaisseur de vitre Glass thickness

00 ø 42, 48, 60 mm 10-12,76 mm

	R /mm	Best.-Nr.	€/ Stk / pcs. ≤ 99	€/ Stk / pcs. ≥ 100
V2A / Inox 304	00	1880-G	8,99	8,69
	42	1880-R42	8,99	8,69
	48	1880-R48	8,99	8,69
	60	1880-R60	8,99	8,69

≥ **8,69**
€/Stk./pcs.

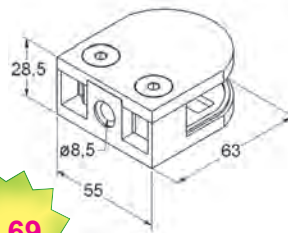
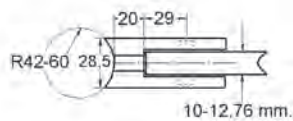

INOX Form 4

Für Flach (G) Profil plat Flat back
Für Rund (R) Profil incurvé Curved back
Für Glas Epaisseur de vitre Glass thickness

00 ø 42, 48, 60 mm 10-12,76 mm

	R /mm	Best.-Nr.	€/ Stk / pcs. ≤ 99	€/ Stk / pcs. ≥ 100
V2A / Inox 304	00	1890-G	9,99	9,69
	42	1890-R42	9,99	9,69
	48	1890-R48	9,99	9,69
	60	1890-R60	9,99	9,69

≥ **9,69**
€/Stk./pcs.

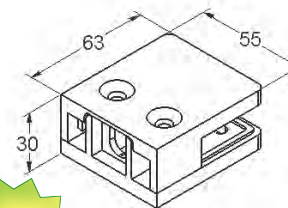
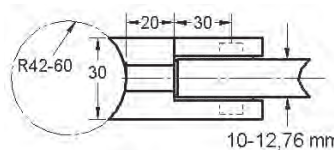

INOX Form 5

Bitte vergessen Sie nicht, bei Ihrer Bestellung Glasstärke und Glasart (VSG oder ESG) anzugeben.
N'oubliez pas dire l'épaisseur et le type de vitre (sécurité ou laminé) dans vos commandes.
Don't forget to notify thickness and kind of glass (security or laminated) in your orders.



Ø 25mm

≥ **4,99**
€/Stk./pcs.

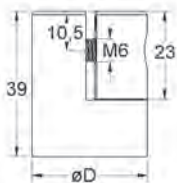

Blechhalter
Pince de fixation concave
Clamp holder with concave back

Nouveau - New
Neu

V4A / INOX 316

	R /mm	D = ø 25mm Best.-Nr.	€/ Stk / pcs.
V2A / Inox 304	gerade	3887-G	4,99
	32	3887-R32	4,99
	42	3887-R42	4,99
	48	3887-R48	4,99



AK BRASS

Messing / Laiton / Brass

≥ **2,69** €/Stk./pcs.



Rohrabschlussstopfen, gewölbt
Embout de fermeture, bombé
End cap, cambered

Rohr/Tube øD x s / mm	Best.-Nr.	€/ Stk / pcs.
26,9 x 2,0	2004	2,69
33,7 x 2,0	2001	2,89
33,7 x 2,6	2005	2,89
42,4 x 2,0	2002	3,09
42,4 x 2,6	2006	3,19
48,3 x 2,0	2003	4,09
48,3 x 2,6	2007	4,19

≥ **3,99** €/Stk./pcs.



Rohrabschlussstopfen, gewölbt mit M8 Gewinde
Embout de fermeture, bombé avec filetage M8
End cap, cambered with M8-thread

Rohr/Tube øD x s / mm	Best.-Nr.	€/ Stk / pcs.
26,9 x 2,0	2004-G	3,99
33,7 x 2,0	2001-G	4,09
33,7 x 2,6	2005-G	4,19
42,4 x 2,0	2002-G	4,29
42,4 x 2,6	2006-G	4,39
48,3 x 2,0	2003-G	5,29
48,3 x 2,6	2007-G	5,39

≥ **5,89** €/Stk./pcs.



Rohr-Kugelstopfen, mit M8 Gewinde
Embout hémisphérique, filetage M8
Hemisphere end cap, with M8-thread

Rohr/Tube øD x s / mm	Best.-Nr.	€/ Stk / pcs.
26,9 x 2,0	2023-G	5,89
33,7 x 2,0	2020-G	6,09
33,7 x 2,6	2024-G	6,09
42,4 x 2,0	2021-G	6,19
42,4 x 2,6	2025-G	6,29
48,3 x 2,0	2022-G	7,19
48,3 x 2,6	2026-G	7,19

≥ **4,69** €/Stk./pcs.



Rohr-Kugelstopfen
Embout hémisphérique / Hemisphere end cap

Rohr/Tube øD x s / mm	Best.-Nr.	€/ Stk / pcs.
26,9 x 2,0	2023	4,69
33,7 x 2,0	2020	4,79
33,7 x 2,6	2024	4,89
42,4 x 2,0	2021	4,99
42,4 x 2,6	2025	4,99
48,3 x 2,0	2022	5,89
48,3 x 2,6	2026	5,99

≥ **12,59** €/Stk./pcs.



Rohr-Knopf
Pommeaux / Knobs

Rohr/Tube øD x s / mm	Best.-Nr.	€/ Stk / pcs.
33,7 x 2,0	2036	12,59
33,7 x 2,6	2037	12,69
42,4 x 2,0	2038	16,59
42,4 x 2,6	2039	16,79
48,3 x 2,0	2040	18,89
48,3 x 2,6	2041	18,99

≥ **12,59** €/Stk./pcs.



Rohr-Knopf
Pommeaux / Knobs

Rohr/Tube øD x s / mm	Best.-Nr.	€/ Stk / pcs.
33,7 x 2,0	2030	12,59
33,7 x 2,6	2033	12,69
42,4 x 2,0	2031	16,59
42,4 x 2,6	2034	16,79
48,3 x 2,0	2032	18,89
48,3 x 2,6	2035	18,99

≥ **2,49** €/Stk./pcs.



Hohlkugeln
Sphères / Spheres

øD /mm	M	Best.-Nr.	€/ Stk / pcs.
20	M6	2626-G	2,49
25	M6	2627-G	2,99
30	M6	2628-G	3,99
35	M6	2629-G	4,99

≥ **15,99** €/Stk./pcs.



Hohlkugeln, mit Gewinde
Sphères, avec pas de vis
Spheres, with screw hole

øD /mm	M	Best.-Nr.	€/ Stk / pcs.
60	M8	2605-G	15,99
70	M8	2606-G	18,49
80	M10	2607-G	23,89
90	M10	2608-G	31,39
100	M10	2609-G	38,19
120	M10	2610-G	63,99
150	M12	2611-G	120,59
200	M12	2612-G	221,39

≥ **5,29** €/Stk./pcs.



Rohr-Abschlusskugeln
Embout sphérique / Sphere end cap

øB /mm	øD /mm	Best.-Nr.	€/ Stk / pcs.
26,9	40	2050	5,29
33,7	45	2051	8,39
42,4	55	2052	11,09
48,3	60	2053	13,29

≥ **2,49** €/Stk./pcs.



Rohranschlussplatten gewölbt
Platines de fixation concaves
Concave montage plates

	Für Rohr-ø	Best.-Nr.	€/Stk.
65 x 25 x 3,0	33,7 mm	2280	2,49
	42,4 mm	2281	2,49
	48,3 mm	2282	2,49
80 x 25 x 3,0	33,7 mm	2283	2,79
	42,4 mm	2284	2,79
	48,3 mm	2285	2,79

≥ **2,79** €/Stk./pcs.

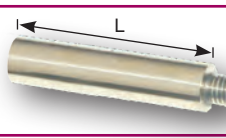

Montagestifte
Rallonge / Extension bar

L/mm	Best.-Nr.	€/Stk/pcs
65	2292	2,79
100	2293	2,99

≥ **1,49** €/Stk./pcs.



Stanzteile / Platines / Plates

øD x s / mm	Best.-Nr.	€/Stk/pcs
40x4	2101	1,49
50x4	2102	1,79
60x4	2103	2,19
70x4	2104	3,29
80x4	2106	3,89
100x4	2108	4,99

Messing / BRASS

Echt Messing - für den Innenbereich empfohlen! / Laiton authentique - conseillé pour utilisation en intérieur! / Real Brass - advised for indoor!

AK BRASS

Abdeckkrosetten / Rosaces / Cover plates

														
ø 75x12 mm	ø 75x22 mm	ø 85x12 mm	ø 85x22 mm	ø 105x22 mm										
øB /mm	Best.-Nr.	€/Stk /pcs	øB /mm	Best.-Nr.	€/Stk /pcs	øB /mm	Best.-Nr.	€/Stk /pcs	øB /mm	Best.-Nr.	€/Stk /pcs			
12,5	2206-12	3,99	12,5	2210-12	4,49	12,5	2218-12	4,99	12,5	2219-12	5,49	34,0	2216-34	6,99
14,5	2206-14	3,99	14,5	2210-14	4,49	14,5	2218-14	4,99	14,5	2219-14	5,49	43,0	2216-43	6,99
34,0	2206-34	3,99	34,0	2210-34	4,49	34,0	2218-34	4,99	34,0	2219-34	5,49	49,0	2216-49	6,99
														
ø 105x22 mm	ø 75x24 mm	ø 85x24 mm	ø 105x38 mm	ø 125x38 mm										
øB /mm	Best.-Nr.	€/Stk /pcs	øB /mm	Best.-Nr.	€/Stk /pcs	øB /mm	Best.-Nr.	€/Stk /pcs	øB /mm	Best.-Nr.	€/Stk /pcs	øB /mm	Best.-Nr.	€/Stk /pcs
43,0	2217-43	8,99	12,5	2201-12	5,49	12,5	2202-12	5,99	34,0	2203-34	7,99	43,0	2204-43	9,99
49,0	2217-49	8,99	14,5	2201-14	5,49	14,5	2202-14	5,99	43,0	2203-43	7,99	49,0	2204-49	9,99
			34,0	2201-34	5,49	34,0	2202-34	5,99	49,0	2203-49	7,99			

Echt Messing - für den Innenbereich empfohlen! / Laiton authentique - conseillé pour utilisation en intérieur! / Real Brass - advised for indoor!

Messing / BRASS

AK BRASS

Handlaufzubehör / Accessoires de main-courantes / Handrail accessories

							
75 x 75 mm aus ø12 mm, mit M6 Innengewinde, Ronde 70x4 mm mit 9 mm Bohrungen angesenkt.	75 x 75 mm aus ø12 mm, mit M8 Aussengewinde, Ronde 70x4 mm mit 9 mm Bohrungen angesenkt.	verstellbar 75 x 75 mm aus ø12 mm Ronde 70x4 mm	Träger mit Abschlusskugel Schenkel 40 mm aus ø12 mm, Ronde 70x4 mm, mit 9 mm Bohrungen Passend für Rohr	Träger mit Durchgangsloch Schenkel 40 mm aus ø12 mm, Ronde 70x4 mm, mit 9 mm Bohrungen Passend für Rohr			
Best.-Nr. 2221	Best.-Nr. 2222	Best.-Nr. 2231					
7,49 €/Stk./pcs.	7,49 €/Stk./pcs.	11,99 €/Stk./pcs.					
Zoll	øB /mm	Best.-Nr.	€/Stk /pcs.	Zoll	øB /mm	Best.-Nr.	€/Stk /pcs.
1"	33,7	2250	13,59	1"	33,7	2252	13,59
1 1/4"	42,4	2251	15,99	1 1/4"	42,4	2253	15,99

AK BRASS

Zierteile / Accessoires / Accessories

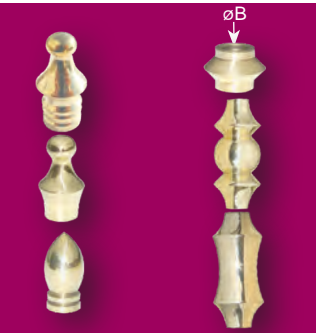
ø 24 x 50 mm zum Kleben	10,2	2980-10	3,99		ø 35 x 24 mm mit Klemmschraube	10,2	2983-10	3,99
	12,2	2980-12	3,99			12,2	2983-12	3,99
	14,2	2980-14	3,99			14,2	2983-14	3,99
ø 24 x 40 mm zum Kleben	10,2	2981-10	3,99			10,2	2984-10	7,99
	12,2	2981-12	3,99			12,2	2984-12	7,99
	14,2	2981-14	3,99			14,2	2984-14	7,99
ø 24 x 18 mm zum Kleben	10,2	2986-10	3,99			10,2	2985-10	7,99
	12,2	2986-12	3,99			12,2	2985-12	7,99
	14,2	2986-14	3,99			14,2	2985-14	7,99

AK FER

Ankerplatten / Platines de fixation / Anchor plates

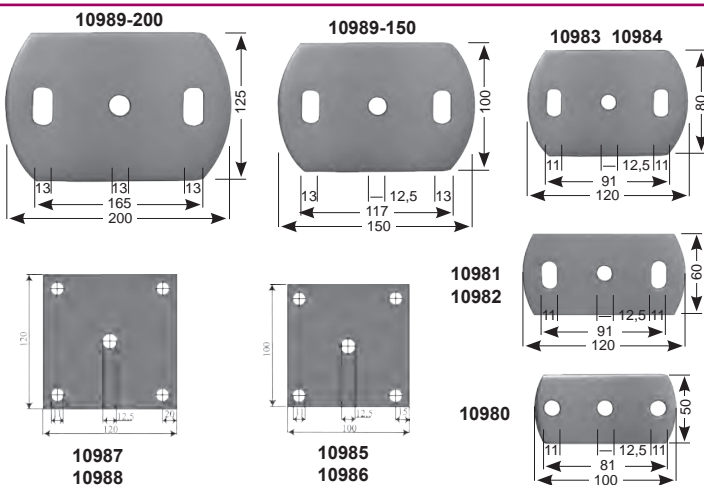

B x H x s /mm	Best.-Nr.	€/Stk /pcs	Paket/Stk/ paquet	Paketabnahme € / Stk / pcs
100 x 50 x 6	10980	0,84	135	0,79
120 x 60 x 6	10981	1,08	100	0,99
120 x 60 x 8	10982	1,18	75	1,10
120 x 80 x 6	10983	1,22	80	1,14
120 x 80 x 8	10984	1,31	60	1,22
100 x 100 x 6	10985	1,31	65	1,22
100 x 100 x 8	10986	1,43	50	1,33
120 x 120 x 6	10987	1,44	44	1,34
120 x 120 x 8	10988	1,59	36	1,49
150 x 100 x 8	10989-150	2,04	32	1,94
200 x 125 x 8	10989-200	3,09	20	2,99

≥ 0,79 €/Stk./pcs.

øD x s /mm	Best.-Nr.	€/Stk /pcs	Paket/ Stk/pcs	Paketabnahme € / Stk / pcs
27 x 3	10948	0,26	100	0,24
30 x 4	10947	0,29	100	0,27
33 x 4	10930	0,31	100	0,29
42 x 4	10931	0,34	100	0,32
48 x 4	10932	0,37	100	0,35
60 x 4	10933	0,52	100	0,49
70 x 4	10934	0,63	100	0,60
70 x 6	10935	0,86	100	0,81
80 x 4	10936	0,79	100	0,74
80 x 6	10937	0,91	100	0,85

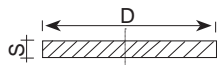

≥ 0,24 €/Stk./pcs.

≥ 0,92 €/Stk./pcs.

øD x s /mm	Best.-Nr.	€/Stk /pcs	Paket/Stk/ paquet	Paketabnahme € / Stk / pcs
80 x 8	10938	1,09	100	0,99
100 x 4	10939	0,99	100	0,92
100 x 6	10940	1,12	80	1,04
100 x 8	10941	1,22	60	1,14
120 x 4	10942	1,17	80	1,09
120 x 6	10943	1,32	55	1,24
120 x 8	10944	1,49	45	1,39
150 x 6	10945	2,39	35	2,29
150 x 8	10946	2,59	27	2,49

Stahl St. 37 / Steel

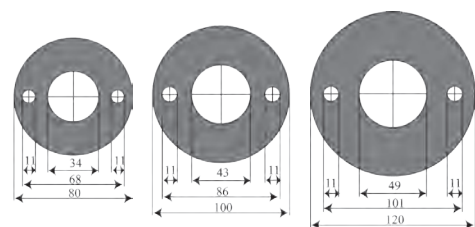

øD x s /mm	Best.-Nr.	€/Stk /pcs	Paket/Stk/ paquet	Paketabnahme € / Stk / pcs
80 x 6	10912	1,10	100	1,04
80 x 8	10913	1,24	100	1,17
100 x 6	10914	1,24	85	1,17
100 x 8	10915	1,37	65	1,29
120 x 6	10916	1,54	60	1,46
120 x 8	10917	1,69	50	1,59

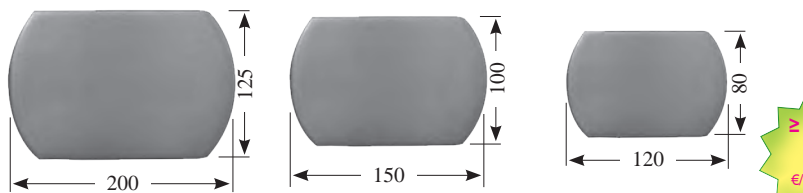

øD x s /mm	Best.-Nr.	€/Stk /pcs	Paket/Stk/ paquet	Paketabnahme € / Stk / pcs
100x100x8	10986-OB	1,38	50	1,28
120x80x8	10984-OB	1,27	60	1,17
120x120x8	10988-OB	1,64	36	1,54
150x100x8	10989-150-OB	1,99	32	1,89
200x125x8	10989-200-OB	2,99	20	2,89

≥ 1,28 €/Stk./pcs.

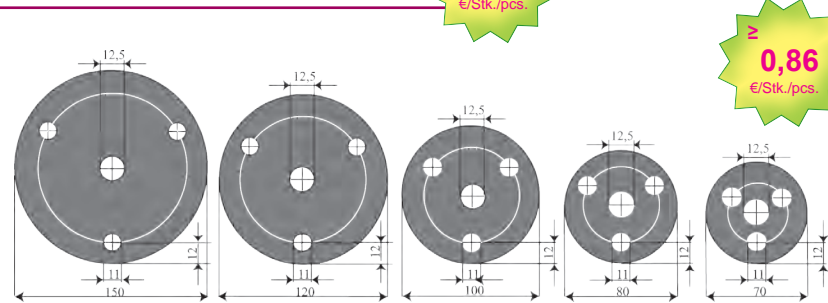

≥ 0,86 €/Stk./pcs.

øD x s /mm	Best.-Nr.	€/Stk /pcs	Paket/Stk/ paquet	Paketabnahme € / Stk / pcs
70 x 6	10920	0,89	100	0,86
80 x 6	10921	0,99	100	0,94
80 x 8	10922	1,17	100	1,09
100 x 6	10923	1,22	85	1,14
100 x 8	10924	1,32	65	1,24
120 x 6	10925	1,42	60	1,34
120 x 8	10926	1,59	45	1,49
150 x 6	10927	2,49	35	2,39
150 x 8	10928	2,69	28	2,59

AK FER

Ankerplatten / Platines de fixation / Anchor plates

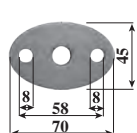

Best.-Nr. 10994

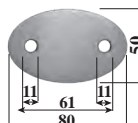

Best.-Nr. 10995

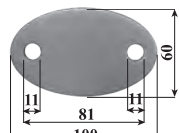

Best.-Nr. 10996

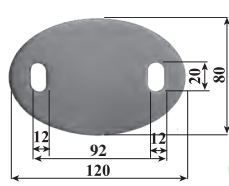

Best.-Nr. 10997

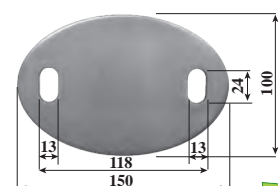

Best.-Nr. 10998

≥ 0,69
€/Stk./pcs.

B x H x s /mm	Best.-Nr.	€/ Stk / pcs. ≤ 99	≥ 100
70 x 45 x 6	10994	0,74	0,69
80 x 50 x 6	10995	0,79	0,74
100 x 60 x 6	10996	0,89	0,84

≥ 1,04
€/Stk./pcs.

B x H x s /mm	Best.-Nr.	€/ Stk / pcs. ≤ 79	≥ 80
120 x 80 x 6	10997	1,14	1,04

≥ 1,49
€/Stk./pcs.

B x H x s /mm	Best.-Nr.	€/ Stk / pcs. ≤ 49	≥ 50
150 x 100 x 6	10998	1,59	1,49

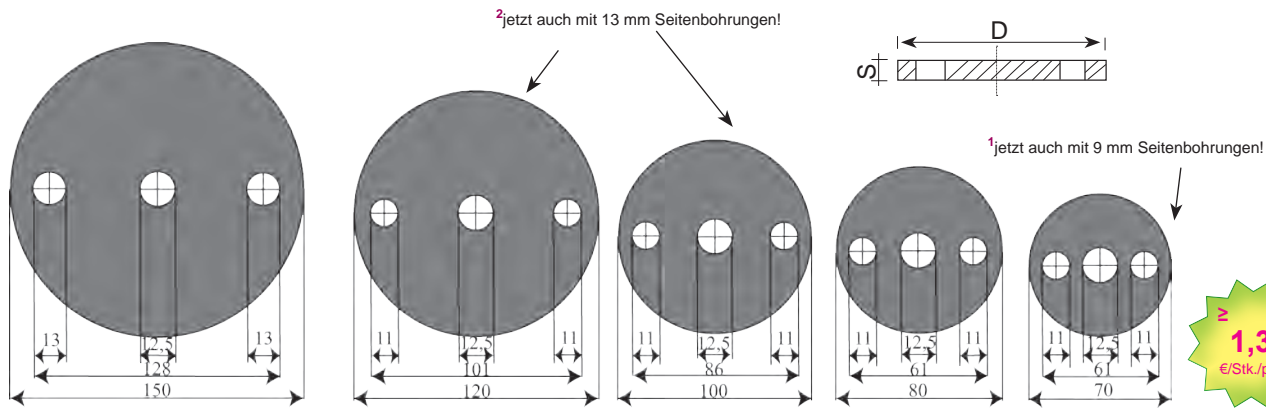

≥ 1,34
€/Stk./pcs.

¹ Seitenbohrungen / Troux latéraux / Edge holes: 9 mm

² Seitenbohrungen / Troux latéraux / Edge holes: 13 mm

≥ 0,86
€/Stk./pcs.

øD x s /mm	Best.-Nr.	€/Stk / pcs	Paket/Stk/ paquet	Paketabnahme € / Stk / pcs
70 x 6	10909 ¹	0,91	100	0,86
70 x 6	10900	0,91	100	0,86
80 x 6	10901	0,99	100	0,94
80 x 8	10903	1,17	100	1,09
100 x 6	10902	1,22	85	1,14
100 x 8	10904	1,32	65	1,24

øD x s /mm	Best.-Nr.	€/Stk / pcs	Paket/Stk/ paquet	Paketabnahme € / Stk / pcs
100 x 8	10910 ²	1,42	65	1,34
120 x 6	10905	1,42	60	1,34
120 x 8	10906	1,59	45	1,49
120 x 8	10911 ²	1,59	45	1,49
150 x 6	10907	2,49	35	2,39
150 x 8	10908	2,69	28	2,59

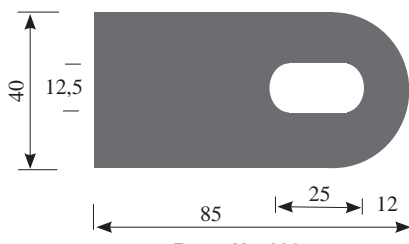

Best.-Nr. 10974

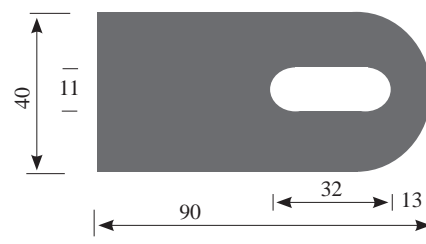

Best.-Nr. 10976

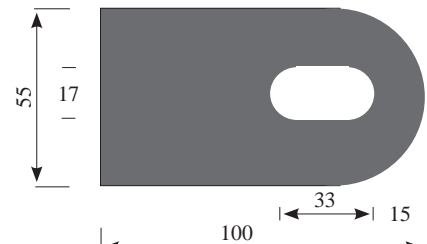

Best.-Nr. 10975

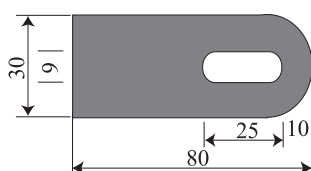

Best.-Nr. 10972

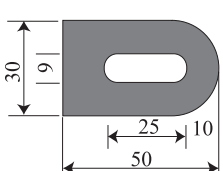

Best.-Nr. 10970

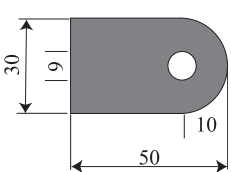

Best.-Nr. 10971

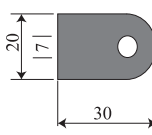

Best.-Nr. 10973

≥ 0,22
€/Stk./pcs.

B x H x s /mm	Best.-Nr.	€/ Stk / pcs. ≤ 99	≥ 100
30 x 20 x 4	10973	0,25	0,22
50 x 30 x 6	10970	0,33	0,30
50 x 30 x 6	10971	0,33	0,30
80 x 30 x 6	10972	0,41	0,38
85 x 40 x 8	10974	0,49	0,46
90 x 40 x 8	10976	0,59	0,56
100 x 55 x 8	10975	0,79	0,74

≥ 1,29
€/Stk./pcs.



Material 2,5 mm

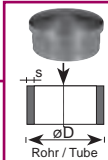

∅D
Rohr / Tube

Rohrabschlussstopfen, gewölbt
Embout de fermeture, Bombé
End cap, Cambered

∅D x s /mm	Best.-Nr.	€/ Stk / pcs.
26,9 x 2,0	12806	1,29
33,7 x 2,0	12800	1,29
33,7 x 2,6	12801	1,29
42,4 x 2,0	12802	1,49
42,4 x 2,6	12803	1,49
48,3 x 2,0	12804	1,89
48,3 x 2,6	12805	1,89
60,3 x 2,0	12807	2,49

≥ 1,29
€/Stk./pcs.



Material 2,5 mm

Rohrabschlussstopfen, flach
Embout de fermeture, Plat
End cap, Flat

∅D x s /mm	Best.-Nr.	€/ Stk / pcs.
26,9 x 2,0	12826	1,29
33,7 x 2,0	12820	1,29
33,7 x 2,6	12821	1,29
42,4 x 2,0	12822	1,49
42,4 x 2,6	12823	1,49
48,3 x 2,0	12824	1,89
48,3 x 2,6	12825	1,89
60,3 x 2,0	12827	2,49



Material 4 mm

Rohr-Kugelstopfen
Embout hémisphérique
Hemisphere end cap

≥ 1,79
€/Stk./pcs.

∅D x s /mm	Best.-Nr.	€/ Stk / pcs.
33,7 x 2,0	12840	1,79
33,7 x 2,6	12841	1,79
42,4 x 2,0	12842	1,99
42,4 x 2,6	12843	1,99
48,3 x 2,0	12844	2,29
48,3 x 2,6	12845	2,29

≥ 1,59
€/Stk./pcs.



Rohrabschlussstopfen, gewölbt mit M8 Gewinde
Embout de fermeture, Bombé avec filetage M8
End cap, Cambered with M8-thread

∅D x s /mm	Best.-Nr.	€/ Stk / pcs.
26,9 x 2,0	12816-G	1,59
33,7 x 2,0	12810-G	1,59
33,7 x 2,6	12811-G	1,59
42,4 x 2,0	12812-G	1,79
42,4 x 2,6	12813-G	1,79
48,3 x 2,0	12814-G	2,19
48,3 x 2,6	12815-G	2,19
60,3 x 2,0	12817-G	2,89

≥ 1,59
€/Stk./pcs.



Rohrabschlussstopfen, flach mit M8 Gewinde
Embout de fermeture, Plat, filetage M8
End cap, Flat, with M8-thread

∅D x s /mm	Best.-Nr.	€/ Stk / pcs.
26,9 x 2,0	12836-G	2,79
33,7 x 2,0	12830-G	1,59
33,7 x 2,6	12831-G	1,59
42,4 x 2,0	12832-G	1,79
42,4 x 2,6	12833-G	1,79
48,3 x 2,0	12834-G	2,19
48,3 x 2,6	12835-G	2,19
60,3 x 2,0	12837-G	2,89

≥ 0,89
€/Stk./pcs.

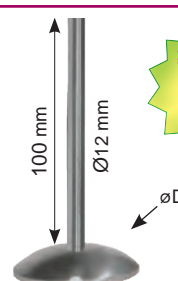

100 mm
∅12 mm
∅D

Handlaufstütze
Support cavalier de main-courante
Floor mounted base

∅D x s /mm	Best.-Nr.	€/ Stk / pcs.
33,7	12990	0,89
42,4	12991	0,99
48,3	12992	1,09
60,3	12993	1,19

≥ 0,99
€/Stk./pcs.

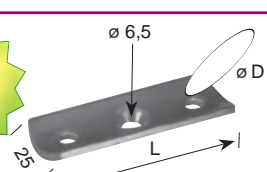

∅6,5
∅D
L
I

∅D /mm	L /mm	Best.-Nr.	€/ Stk / pcs. ≤ 99	€/ Stk / pcs. ≥ 100
33,7	65	12980	1,09	0,99
42,4	65	12981	1,09	0,99
48,3	65	12982	1,09	0,99
33,7	80	12983	1,19	1,09
42,4	80	12984	1,19	1,09
48,3	80	12985	1,19	1,09

Handlaufträger mit 2-Loch
Supports de main-courante avec deux trous
Handrail brackets with two holes



75 x 75 mm
∅12 mm
∅B
Top

≥ 1,79
€/Stk./pcs.

∅D x s /mm	∅B /mm	Best.-Nr.	€/ Stk / pcs. ≤ 99	€/ Stk / pcs. ≥ 100
70 x 6 mm	9	10990	1,89	1,79
80 x 6 mm	9	10992	1,99	1,89
70 x 6 mm	11	10991	1,89	1,79
80 x 6 mm	11	10993	1,99	1,89

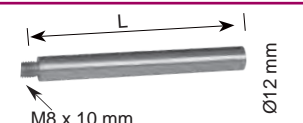

M8 x 10 mm
∅12 mm
L
I

L /mm	Best.-Nr.	€/ Stk / pcs.
65	12995	0,89
100	12996	0,94

Abdeckrosetten
Rosaces / Cover plates

1,59
€/Stk./pcs.

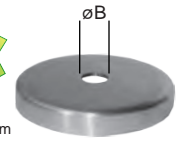

Material 1,5 mm
∅B
∅75 x 12 mm

∅B /mm	Best.-Nr.	€/Stk / pcs.
12,5	12940	1,59
14,5	12941	1,59
34	12942	1,59
43	12943	1,59

1,79
€/Stk./pcs.



Material 1,5 mm
∅B
∅85 x 12 mm

∅B /mm	Best.-Nr.	€/Stk / pcs.
12,5	12936	1,79
14,5	12937	1,79
34	12938	1,79
43	12939	1,79

1,99
€/Stk./pcs.



∅105 x 22 mm
∅B
∅B /mm

Best.-Nr.	€/Stk / pcs.	
34	12945	1,99
43	12946	1,99
49	12947	1,99

2,39
€/Stk./pcs.



∅125 x 22 mm
∅B
∅B /mm

Best.-Nr.	€/Stk / pcs.	
43	12948	2,39
49	12949	2,39

Nieten



Schaft/mm	Best.-Nr.	€/Stk./pcs.
6 x 20	12420	0,10
6 x 25	12421	0,12
6 x 30	12422	0,13
6 x 35	12423	0,15
6 x 40	12424	0,17
6 x 50	12425	0,20
8 x 20	12426	0,13
8 x 25	12427	0,15
8 x 30	12428	0,16
8 x 35	12429	0,18
8 x 40	12430	0,20
8 x 50	12431	0,23



Hohlkugeln
Sphères / Spheres

øD /mm	Best.-Nr.	€/ Stk / pcs.	
		≤ 99	≥ 100
30	12508	0,76	0,71
40	12501	0,97	0,91
50	12502	1,53	1,48
60	12503	1,68	1,63
70	12505	2,81	2,70
80	12504	3,19	2,99
90	12506	4,49	4,34
100	12507	6,54	6,28
120	12509	10,20	9,69
150	12510	20,43	19,40
200	12511	51,10	49,57

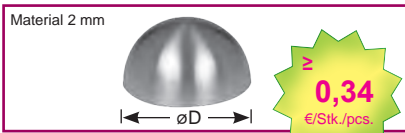

Halbhohlkugeln
Demi-sphère / Hemisphere

øD /mm	Best.-Nr.	€/ Stk / pcs.	
26,9	12516	0,34	
30	12520	0,37	
33,7	12517	0,42	
40	12521	0,43	
42,4	12518	0,48	
48,3	12519	0,57	
50	12522	0,57	
60	12523	0,69	
70	12525	0,89	
80	12524	1,49	
90	12526	1,69	
100	12527	2,49	
120	12528	4,99	
150	12529	9,39	
200	12530	19,99	

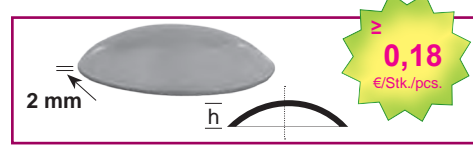

Schale gewölbt
Fermeture bombée / Domed cap

øD /mm	h /mm	Rohr-Tube /Zoll	Best.-Nr.	€/ Stk / pcs.	
				≤ 99	≥ 100
21	6	1/2"	10953	0,20	0,18
26,9	7	3/4"	10954	0,24	0,22
33	8	1"	10960	0,25	0,23
42	9	1 1/4"	10961	0,28	0,26
48	10	1 1/2"	10962	0,34	0,31
52	10	1 3/4"	10955	0,39	0,36
60	11	2"	10963	0,56	0,52
70	11	2 1/4"	10964	0,62	0,57
76	11	2 1/2"	10956	0,74	0,68
89	12	3"	10957	1,09	1,03
100	12	3 1/2"	10965	1,26	1,19
113	13	4"	10958	1,54	1,45
120	13	4 1/2"	10959	1,79	1,70



Vollkugeln
Sphère pleine / Solid ball

øD /mm	Best.-Nr.	€/ Stk / pcs.	
		≤ 99	≥ 100
15	12540	0,24	0,22
20	12541	0,29	0,27
25	12542	0,34	0,32
30	12543	0,39	0,36
35	12544	0,64	0,59
40	12546	0,89	0,84
50	12547	1,39	1,29



Schweissbogen
Coude / Elbow

øD x s /mm	Best.-Nr.	€/ Stk / pcs.	
		≤ 99	≥ 100
26,9 x 2,0	12997-26	0,89	0,79
33,7 x 2,6	12997-33	0,99	0,89
42,4 x 2,6	12997-42	1,09	0,99
48,3 x 2,6	12997-48	1,29	1,19
60,3 x 2,6	12997-60	1,69	1,59

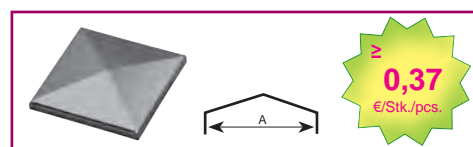

Abdeckkappen
Embouts pyramaux / Angular caps

A /mm	Best.-Nr.	€/ Stk / pcs.	
		≤ 99	≥ 100
20 x 20	12900	0,39	0,37
20 x 30	12901	0,42	0,39
20 x 40	12902	0,44	0,41
30 x 30	12903	0,44	0,41
30 x 40	12904	0,49	0,44
30 x 50	12905	0,57	0,52
40 x 40	12906	0,57	0,52
40 x 60	12907	0,63	0,58
50 x 50	12908	0,63	0,58
60 x 60	12909	0,69	0,64
80 x 80	12910	0,89	0,84
100 x 100	12911	1,39	1,29
120 x 120	12912	1,79	1,69
150 x 150	12913	2,29	2,19

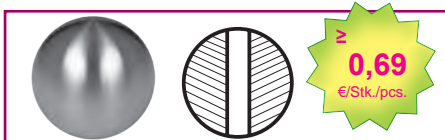

Vollkugel mit Durchgangsbohrung 12,5 mm
Sphère pleine troué taille - à calibre 12,5 mm
Solid ball with 12,5 mm hole

øD /mm	Best.-Nr.	bis 99 €/Stk.	ab 100 €/Stk.
25	12545-25	0,79	0,69
30	12545-30	0,89	0,79
35	12545-35	1,19	1,09

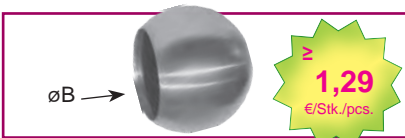

Rohr-Abschlusskugeln
Embout sphérique / Sphere end cap

øB /mm	Zoll	øD /mm	Best.-Nr.	€/Stk / pcs.
26,9	3/4"	40	12550	1,29
33,7	1"	45	12551	1,49
42,4	1 1/4"	55	12552	1,69
48,3	1 1/2"	60	12553	1,89



Rohr-Knopf
Pommeaux / Knobs

øD2 /mm	øD1 /mm	Best.-Nr.	€/Stk / pcs.
42	30	12950	2,69
48	40	12951	2,99
60	50	12952	3,49



Vollkugeln mit Sackloch 12,5 mm
Embout sphérique 12,5 mm
Spheres, with blind hole 12,5 mm

øD /mm	Best.-Nr.	€/ Stk / pcs.	
		≤ 99	≥ 100
25	12548-25	0,79	0,69
30	12548-30	0,89	0,79

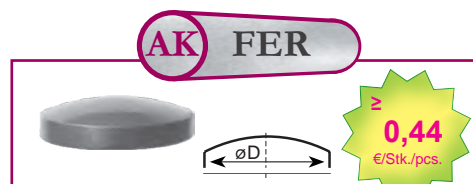

Runde Abdeckkappen
Fermeture ronde / Round cap

øD /mm	Best.-Nr.	€/ Stk / pcs.
33	12920	0,44
42	12921	0,49
48	12922	0,50
60	12923	0,69
101	12924	1,29

AK FER

Schnörkel / Volutes / Scrolls

Best.-Nr.6000
80 x 50 mm, 0,13 kg

Stk./pcs.	€/Stk./ pcs.
< 149	0,62
> 150	0,57



Best.-Nr. 6001
100 x 65 mm, 0,15 kg

Stk./pcs.	€/Stk./ pcs.
< 149	0,62
> 150	0,57



Best.-Nr. 6002
120 x 70 mm, 0,17 kg

Stk./pcs.	€/Stk./ pcs.
< 149	0,67
> 150	0,62



Best.-Nr. 6031
140 x 80 mm, 0,20 kg

Stk./pcs.	€/Stk./ pcs.
< 124	0,79
> 125	0,73



Best.-Nr. 6003
160 x 90 mm, 0,23 kg

Stk./pcs.	€/Stk./ pcs.
< 124	0,94
> 125	0,84



Best.-Nr. 6032
180 x 100 mm, 0,25 kg

Stk./pcs.	€/Stk./ pcs.
< 99	1,04
> 100	0,94



Best.-Nr. 6004
220 x 120 mm, 0,34 kg

Stk./pcs.	€/Stk./ pcs.
< 79	1,15
> 80	1,05



Best.-Nr. 6035
60 x 120 mm, 0,12 kg

Stk./pcs.	€/Stk./ pcs.
< 149	0,73
> 150	0,63



Best.-Nr. 6011
80 x 80 mm, 0,12 kg

Stk./pcs.	€/Stk./ pcs.
< 149	0,73
> 150	0,63



Best.-Nr. 6036
60 x 120 mm, 0,15 kg

Stk./pcs.	€/Stk./ pcs.
< 124	0,83
> 125	0,74



Best.-Nr. 6005
80 x 170 mm, 0,23 kg

Stk./pcs.	€/Stk./ pcs.
< 124	0,94
> 125	0,84



Best.-Nr. 6085
110 x 240 mm, 0,33 kg

Stk./pcs.	€/Stk./ pcs.
< 74	1,26
> 75	1,16



Professional Quality !

Best.-Nr. 6072
120 x 260 mm, 0,44 kg

Stk./pcs.	€/Stk./ pcs.
< 59	1,47
> 60	1,37



Best.-Nr. 6009
130 x 330 mm, 0,41 kg

Stk./pcs.	€/Stk./ pcs.
< 59	1,36
> 60	1,26



Best.-Nr. 6078
95 x 135 mm, 0,22 kg

Stk./pcs.	€/Stk./ pcs.
< 99	1,04
> 100	0,94



Best.-Nr. 6006
140 x 190 mm, 0,33 kg

Stk./pcs.	€/Stk./ pcs.
< 99	1,26
> 100	1,16



Best.-Nr. 6007
100 x 150 mm, 0,22 kg

Stk./pcs.	€/Stk./ pcs.
< 124	0,94
> 125	0,84



Best.-Nr. 6010
100 x 50 mm, 0,14 kg

Stk./pcs.	€/Stk./ pcs.
< 149	1,15
> 150	1,05



Best.-Nr. 6037
60 x 220 mm, 0,19 kg

Stk./pcs.	€/Stk./ pcs.
< 124	1,04
> 125	0,94



Best.-Nr. 6008
75 x 210 mm, 0,23 kg

Stk./pcs.	€/Stk./ pcs.
< 99	1,15
> 100	1,05



Best.-Nr. 6038
60 x 220 mm, 0,21 kg

Stk./pcs.	€/Stk./ pcs.
< 124	1,04
> 125	0,94



Best.-Nr. 6071
140 x 330 mm, 0,58 kg

Stk./pcs.	€/Stk./ pcs.
< 59	1,57
> 60	1,47

plain edges

Best.-Nr. 6012
80 x 160 mm, 0,16 kg

Stk./pcs.	€/Stk./ pcs.
< 149	0,73
> 150	0,63



Best.-Nr. 6033
260 x 70 mm, 0,29 kg

Stk./pcs.	€/Stk./ pcs.
< 99	1,26
> 100	1,16



AK FER

Best.-Nr. 6230
120 x 80 mm, 0,20 kg

Stk./pcs.	€/Stk./ pcs.
< 99	1,26
> 100	1,16



Best.-Nr. 6034
270 x 75 mm, 0,29 kg

Stk./pcs.	€/Stk./ pcs.
< 99	1,26
> 100	1,16



AK FER

Schnörkel - kantengehämmert
Volutes martelées / Scrolls - hammered edges

Best.-Nr. 6100
80 x 50 mm, 0,13 kg

Stk./pcs.	€/Stk./ pcs.
< 149	0,75
> 150	0,65

Best.-Nr. 6101
100 x 60 mm, 0,15 kg

Stk./pcs.	€/Stk./ pcs.
< 149	0,75
> 150	0,65

Best.-Nr. 6102
120 x 70 mm, 0,16 kg

Stk./pcs.	€/Stk./ pcs.
< 149	0,79
> 150	0,69

Best.-Nr. 6131
140 x 80 mm, 0,19 kg

Stk./pcs.	€/Stk./ pcs.
< 124	0,91
> 125	0,81

Best.-Nr. 6103
160 x 90 mm, 0,22 kg

Stk./pcs.	€/Stk./ pcs.
< 124	1,02
> 125	0,92

Best.-Nr. 6132
180 x 100 mm, 0,24 kg

Stk./pcs.	€/Stk./ pcs.
< 99	1,13
> 100	1,03

Best.-Nr. 6104
220 x 120 mm, 0,33 kg

Stk./pcs.	€/Stk./ pcs.
< 79	1,34
> 80	1,24

Best.-Nr. 6130
120 x 80 mm, 0,18 kg

Stk./pcs.	€/Stk./ pcs.
< 99	1,24
> 100	1,14

Best.-Nr. 6110
100 x 50 mm, 0,14 kg

Stk./pcs.	€/Stk./ pcs.
< 149	1,08
> 150	0,88

Best.-Nr. 6136
60 x 120 mm, 0,15 kg

Stk./pcs.	€/Stk./ pcs.
< 124	0,91
> 125	0,81

Best.-Nr. 6105
80 x 170 mm, 0,22 kg

Stk./pcs.	€/Stk./ pcs.
< 124	1,02
> 125	0,92

Best.-Nr. 6172
120 x 260 mm, 0,42 kg

Stk./pcs.	€/Stk./ pcs.
< 59	1,56
> 60	1,46

Best.-Nr. 6185
110 x 240 mm, 0,32 kg

Stk./pcs.	€/Stk./ pcs.
< 74	1,39
> 75	1,29

Best.-Nr. 6109
130 x 330 mm, 0,39 kg

Stk./pcs.	€/Stk./ pcs.
< 59	1,46
> 60	1,36

Best.-Nr. 6171
140 x 330 mm, 0,55 kg

Stk./pcs.	€/Stk./ pcs.
< 59	1,62
> 60	1,52

Best.-Nr. 6111
80 x 80 mm, 0,12 kg

Stk./pcs.	€/Stk./ pcs.
< 149	0,75
> 150	0,65

Best.-Nr. 6112
80 x 160 mm, 0,16 kg

Stk./pcs.	€/Stk./ pcs.
< 149	0,79
> 150	0,69

Best.-Nr. 6178
95 x 135 mm, 0,21 kg

Stk./pcs.	€/Stk./ pcs.
< 99	1,08
> 100	0,98

Best.-Nr. 6106
140 x 190 mm, 0,32 kg

Stk./pcs.	€/Stk./ pcs.
< 99	1,34
> 100	1,24

Best.-Nr. 6107
100 x 150 mm, 0,21 kg

Stk./pcs.	€/Stk./ pcs.
< 124	1,02
> 125	0,92

Best.-Nr. 6135
60 x 120 mm, 0,12 kg

Stk./pcs.	€/Stk./ pcs.
< 149	0,85
> 150	0,75

Best.-Nr. 6137
60 x 220 mm, 0,18 kg

Stk./pcs.	€/Stk./ pcs.
< 124	1,02
> 125	0,92

Best.-Nr. 6108
75 x 210 mm, 0,22 kg

Stk./pcs.	€/Stk./ pcs.
< 99	1,24
> 100	1,14

Best.-Nr. 6138
60 x 220 mm, 0,20 kg

Stk./pcs.	€/Stk./ pcs.
< 124	1,13
> 125	1,03

Best.-Nr. 6134
270 x 75 mm, 0,28 kg

Stk./pcs.	€/Stk./ pcs.
< 99	1,39
> 100	1,29

Best.-Nr. 6133
260 x 70 mm, 0,28 kg

Stk./pcs.	€/Stk./ pcs.
< 99	1,39
> 100	1,29



AK FER

AK FER

Leichtbarock-Schnörkel Volutes - Baroque Léger / Light Baroque scrolls

Best.-Nr. 6201
120 x 80 mm, 0,20 kg



Stk./pcs.	€/Stk./ pcs.
< 124	0,91
> 125	0,81

Best.-Nr. 6202
140 x 90 mm, 0,22 kg



Stk./pcs.	€/Stk./ pcs.
< 124	1,02
> 125	0,92

Best.-Nr. 6203
160 x 90 mm, 0,24 kg



Stk./pcs.	€/Stk./ pcs.
< 99	1,13
> 100	1,03

Best.-Nr. 6205
220 x 130 mm, 0,33 kg



Stk./pcs.	€/Stk./ pcs.
< 79	1,56
> 80	1,46

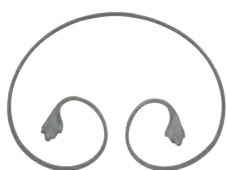

Best.-Nr. 6260
300 x 220 mm
0,62 kg
3,76 €/Stk./pcs.



Best.-Nr. 6246

70 x 190 mm
0,22 kg
1,62 €/Stk./pcs.



Best.-Nr. 6231

55 x 260 mm
0,20 kg
Stk./pcs. €/Stk./ pcs.
< 124 **1,46**
> 125 **1,36**



Best.-Nr. 6236

105 x 180 mm
0,26 kg
2,16 €/Stk./pcs.



Best.-Nr. 6261
440 x 350 mm, 0,91 kg
4,85 €/Stk./pcs.



Best.-Nr. 6224



Best.-Nr. 6225

80 x 80 mm
0,12 kg
Stk./pcs. €/Stk./ pcs.
< 149 **0,79**
> 150 **0,69**



Best.-Nr. 6226



Best.-Nr. 6227

80 x 160 mm
0,17 kg
Stk./pcs. €/Stk./ pcs.
< 149 **0,91**
> 150 **0,81**



Best.-Nr. 6220



Best.-Nr. 6221

85 x 125 mm
0,15 kg
Stk./pcs. €/Stk./ pcs.
< 149 **0,91**
> 150 **0,81**



Best.-Nr. 6222



Best.-Nr. 6223

105 x 150 mm
0,15 kg
Stk./pcs. €/Stk./ pcs.
< 149 **1,13**
> 150 **1,03**



Best.-Nr. 6238



Best.-Nr. 6239

140 x 190 mm
0,34 kg
Stk./pcs. €/Stk./ pcs.
< 79 **1,49**
> 80 **1,39**



Best.-Nr. 6240



Best.-Nr. 6241

80 x 170 mm
0,23 kg
Stk./pcs. €/Stk./ pcs.
< 99 **1,13**
> 100 **1,03**

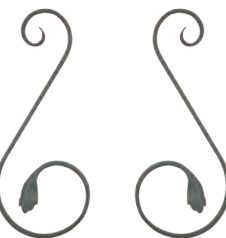

Best.-Nr. 6244



Best.-Nr. 6245

140 x 330 mm
0,41 kg
Stk./pcs. €/Stk./ pcs.
< 59 **1,62**
> 60 **1,52**



Best.-Nr. 6254

200 x 320 mm, 0,50 kg
3,29 €/Stk./pcs.



Best.-Nr. 6255

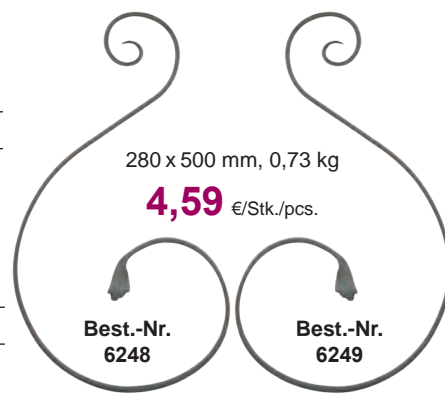

280 x 500 mm, 0,73 kg

4,59 €/Stk./pcs.

Best.-Nr. 6248

Best.-Nr. 6249



210 x 400mm, 0,54 kg

3,99 €/Stk./pcs.

Best.-Nr. 6258

Best.-Nr. 6259



240 x 400 mm, 0,62 kg

3,99 €/Stk./pcs.

Best.-Nr. 6256

Best.-Nr. 6257

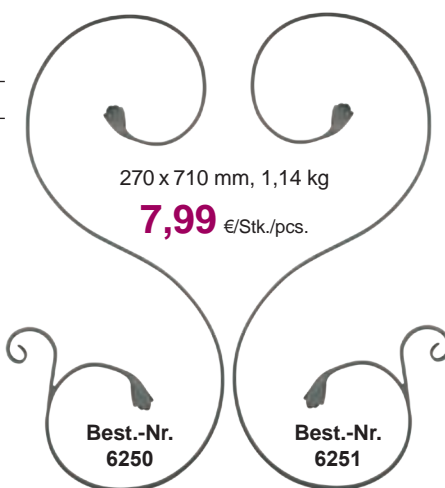

270 x 710 mm, 1,14 kg

7,99 €/Stk./pcs.

Best.-Nr. 6250

Best.-Nr. 6251

AK FER

Landbarock-Schnörkel
Volutes - Baroque de Pays / Country Baroque Scrolls

Best.-Nr.
14323



210 x 400 mm, 0,83 kg

6,49 €/Stk./pcs.

Best.-Nr.
14324



Best.-Nr. 14300
120 x 70 mm, 0,27 kg

1,36 €/Stk./pcs.

200 x 320 mm, 0,77 kg

6,49 €/Stk./pcs.



Best.-Nr.
14313



Best.-Nr.
14314



Best.-Nr.
14325

280 x 500 mm, 0,67 kg

7,99 €/Stk./pcs.

Best.-Nr.
14326



Best.-Nr. 14302
160 x 90 mm, 0,32 kg

1,69 €/Stk./pcs.

240 x 400 mm, 0,97 kg

7,99 €/Stk./pcs.



Best.-Nr.
14315



Best.-Nr.
14316



7,49 €/Stk./pcs.

Best.-Nr. 14329
300 x 220 mm, 0,96 kg



Best.-Nr. 14304
220 x 130 mm, 0,50 kg

1,99 €/Stk./pcs.



Best.-Nr. 14334
350 x 90 mm, 0,50 kg

4,89 €/Stk./pcs.



Best.-Nr. 14330
440 x 350 mm, 1,55 kg

9,19 €/Stk./pcs.



Detail Ausschmiedung: Blätter aus einem Stück geschmiedet
Patte d'oie. Finition sans soudure forgée à même la pièce
Forge Detail: leaves are forged from one piece of iron without welding



Best.-Nr.
14311

130 x 200 mm, 0,51 kg

4,89 €/Stk./pcs.



Best.-Nr.
14312



Best.-Nr.
14327



Best.-Nr.
14328

270 x 710 mm, 1,80 kg

11,99 €/Stk./pcs.



Best.-Nr.
14333

90 x 270 mm, 0,44 kg

3,49 €/Stk./pcs.



Best.-Nr.
14332

E-mail: info@akbas-schmiedeeisen.de, www.akbas-schmiedeeisen.de

Tel: +49(0) 61 44 33 05-0, Fax: +49(0) 61 44 33 05-15

Tel: +33.3.68680131, E-mail: vente@akbas-schmiedeeisen.de, Tel: +44.151.6018946, E-mail: sales@akbas-schmiedeeisen.de

AK FER

Meisterbarock-Schnörkel
Volutes - Baroque de Maître / Master Baroque Scrolls



7,59 €/Stk./pcs.

Best.-Nr. 14129
300 x 220 mm, 1,30 kg

130 x 200 mm, 0,57 kg

4,39 €/Stk./pcs.

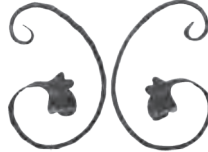

Best.-Nr. 14111 Best.-Nr. 14112

200 x 320 mm, 0,84 kg

5,99 €/Stk./pcs.

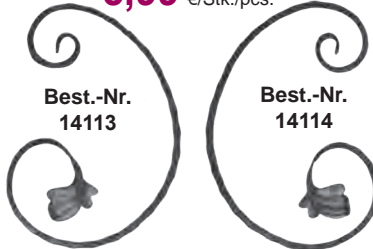

Best.-Nr. 14113

Best.-Nr. 14114

240 x 400 mm, 1,07 kg

7,59 €/Stk./pcs.



Best.-Nr. 14115

Best.-Nr. 14116

210 x 400 mm, 0,88 kg

5,99 €/Stk./pcs.



Best.-Nr. 14123

Best.-Nr. 14124

280 x 500 mm, 1,21 kg

7,59 €/Stk./pcs.

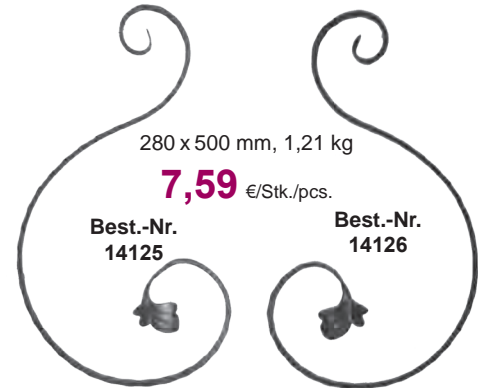

Best.-Nr. 14125

Best.-Nr. 14126

140 x 420 mm, 0,80 kg

7,59 €/Stk./pcs.



Best.-Nr. 14121

Best.-Nr. 14122

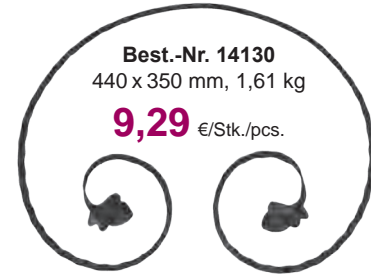

Best.-Nr. 14130
440 x 350 mm, 1,61 kg

9,29 €/Stk./pcs.

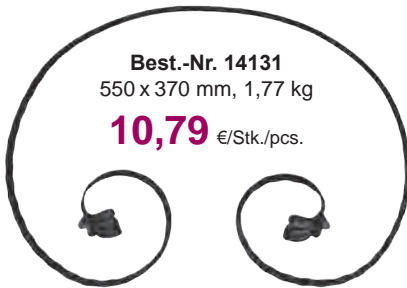

Best.-Nr. 14131
550 x 370 mm, 1,77 kg

10,79 €/Stk./pcs.



Best.-Nr. 14100
120 x 70 mm, 0,26 kg

1,36 €/Stk./pcs.



Best.-Nr. 14102
160 x 90 mm, 0,39 kg

1,69 €/Stk./pcs.



Best.-Nr. 14104
220 x 130 mm, 0,55 kg

1,99 €/Stk./pcs.



Best.-Nr. 14132

Best.-Nr. 14133

70 x 200 mm,
0,38 kg

3,79 €/Stk./pcs.



Best.-Nr. 14110

130 x 200 mm, 0,54 kg

1,89 €/Stk./pcs.



Best.-Nr. 14108
100 x 160 mm, 0,40 kg

1,79 €/Stk./pcs.



Best.-Nr. 14107

140 x 330 mm, 0,81 kg

2,49 €/Stk./pcs.

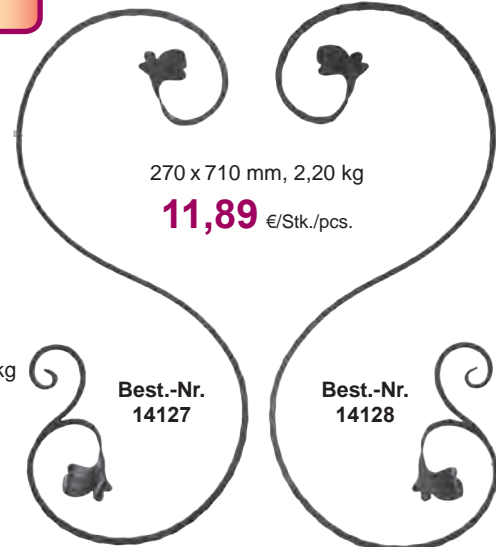

270 x 710 mm, 2,20 kg

11,89 €/Stk./pcs.

Best.-Nr. 14127

Best.-Nr. 14128



Detail Ausschmiedung
Patte d'oie / Forge Detail

AK FER

Schwerbarock-Schnörkel Volutes - Baroque Lourde / Heavy Baroque Scrolls

130 x 200 mm, 0,50 kg

4,39 €/Stk./pcs.



Best.-Nr.
14212

Best.-Nr.
14211

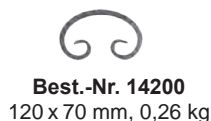

Best.-Nr. 14200

120 x 70 mm, 0,26 kg

1,39 €/Stk./pcs.



Best.-Nr. 14202

160 x 90 mm, 0,37 kg

1,69 €/Stk./pcs.



Best.-Nr. 14207

140 x 330 mm, 0,89 kg

2,49 €/Stk./pcs.



7,59 €/Stk./pcs.

Best.-Nr. 14229

300 x 220 mm, 1,20 kg

200 x 320 mm, 0,84 kg

5,99 €/Stk./pcs.



Best.-Nr.
14213

Best.-Nr.
14214



Best.-Nr. 14204

220 x 130 mm, 0,55 kg

1,99 €/Stk./pcs.



Best.-Nr. 14210

130 x 200 mm, 0,57 kg

1,89 €/Stk./pcs.



Best.-Nr. 14230

440 x 350 mm, 1,60 kg

9,29 €/Stk./pcs.

240 x 400 mm, 1,01 kg

7,59 €/Stk./pcs.



Best.-Nr.
14215

Best.-Nr.
14216



Best.-Nr. 14208

100 x 160 mm, 0,37 kg

1,79 €/Stk./pcs.



Best.-Nr. 14231

550 x 370 mm, 1,65 kg

10,79 €/Stk./pcs.

140 x 330 mm, 1,20 kg

6,99 €/Stk./pcs.

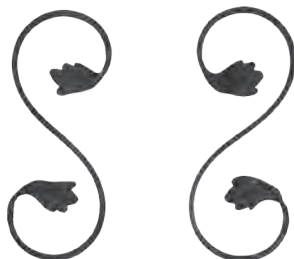

Best.-Nr.
14234

Best.-Nr.
14235



Detail Ausschmiedung
Patte d'oie/ Forge Detail

Best.-Nr.
14223

Best.-Nr.
14224



210 x 400 mm, 1,21 kg

5,99 €/Stk./pcs.

140 x 420 mm, 0,80 kg

7,59 €/Stk./pcs.



Best.-Nr.
14221

Best.-Nr.
14222

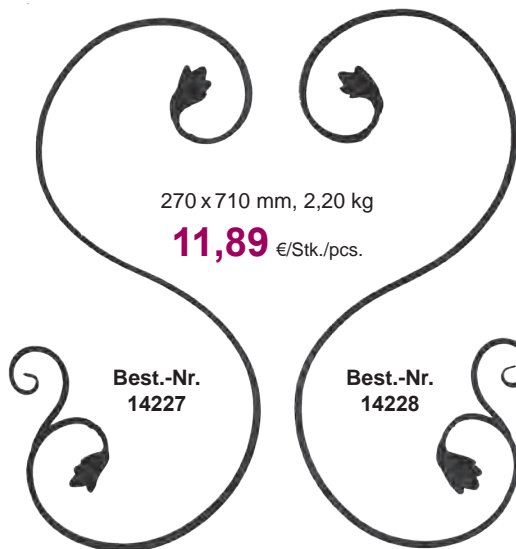

270 x 710 mm, 2,20 kg

11,89 €/Stk./pcs.

Best.-Nr.
14227

Best.-Nr.
14228

Best.-Nr.
14225

Best.-Nr.
14226



280 x 500 mm, 1,14 kg

7,59 €/Stk./pcs.

E-mail: info@akbas-schmiedeeisen.de, www.akbas-schmiedeeisen.de

Tel: +49(0) 61 44 33 05-0, Fax: +49(0) 61 44 33 05-15

Tel: +33.3.68680131, E-mail: vente@akbas-schmiedeeisen.de, Tel: +44.151.6018946, E-mail: sales@akbas-schmiedeeisen.de



Akhas

Schmiedeeisen & Metallwaren

Länge / Longueur / Length
ca. 900 mm

Stab / Barreau / Baluster
ø 12 mm

AK FER

Designstäbe / Barreaux design / Design bars

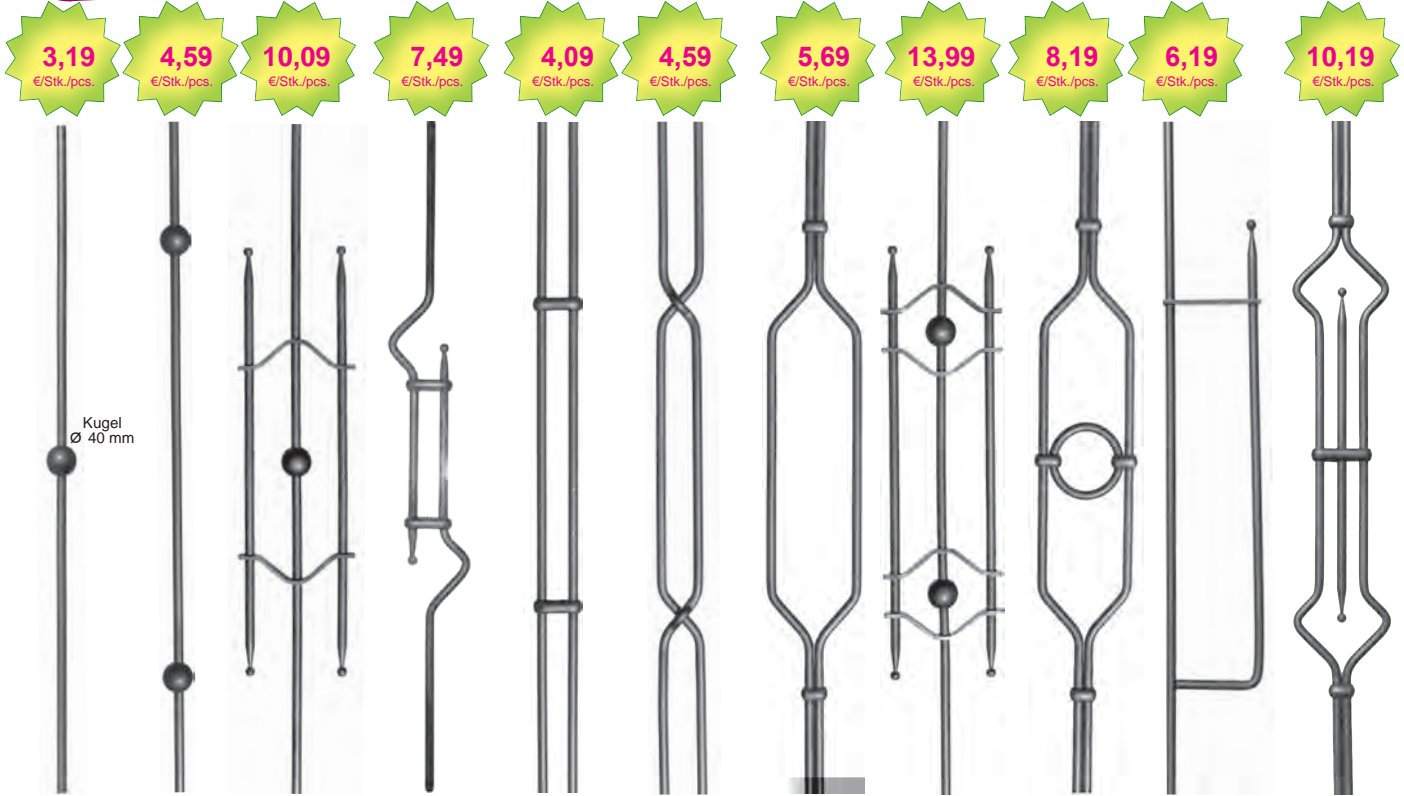

3,19 €/Stk./pcs.	4,59 €/Stk./pcs.	10,09 €/Stk./pcs.	7,49 €/Stk./pcs.	4,09 €/Stk./pcs.	4,59 €/Stk./pcs.	5,69 €/Stk./pcs.	13,99 €/Stk./pcs.	8,19 €/Stk./pcs.	6,19 €/Stk./pcs.	10,19 €/Stk./pcs.
Best.-Nr. 5500 40 x 40 mm 0,91 kg	Best.-Nr. 5501 40 x 600 mm 0,97kg	Best.-Nr. 5512 150 x 550 mm 2,18 kg	Best.-Nr. 5521 110 x 430 mm 1,40 kg	Best.-Nr. 5502 55 x 900 mm 1,87 kg	Best.-Nr. 5503 60 x 900 mm 1,84 kg	Best.-Nr. 5506 125 x 460 mm 1,77 kg	Best.-Nr. 5513 150 x 550 mm 2,45 kg	Best.-Nr. 5507 125 x 460 mm 2,17 kg	Best.-Nr. 5505 120 x 600 mm 1,59 kg	Best.-Nr. 5508 130 x 540 mm 2,34 kg

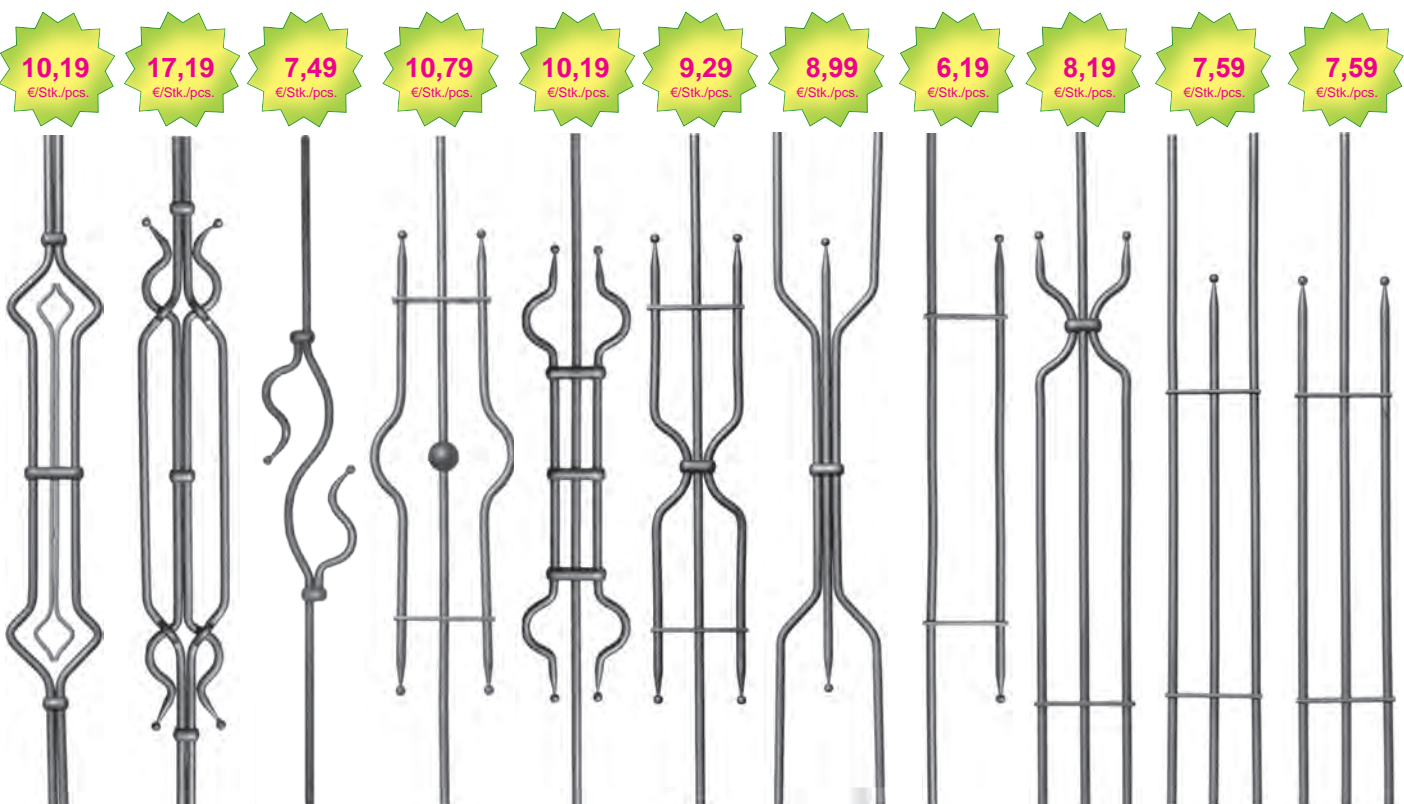

10,19 €/Stk./pcs.	17,19 €/Stk./pcs.	7,49 €/Stk./pcs.	10,79 €/Stk./pcs.	10,19 €/Stk./pcs.	9,29 €/Stk./pcs.	8,99 €/Stk./pcs.	6,19 €/Stk./pcs.	8,19 €/Stk./pcs.	7,59 €/Stk./pcs.	7,59 €/Stk./pcs.
Best.-Nr. 5509 130 x 540 mm 2,50 kg	Best.-Nr. 5510 125 x 660 mm 3,12 kg	Best.-Nr. 5520 125 x 355 mm 1,50 kg	Best.-Nr. 5519 190 x 600 mm 2,14 kg	Best.-Nr. 5516 140 x 600 mm 2,18 kg	Best.-Nr. 5517 125 x 600 mm 2,26kg	Best.-Nr. 5518 140 x 600 mm 2,39 kg	Best.-Nr. 5504 105 x 600 mm 1,53 kg	Best.-Nr. 5511 125 x 700 mm 2,43 kg	Best.-Nr. 5515 125 x 700 mm 2,56 kg	Best.-Nr. 5514 125 x 700 mm 2,32 kg

Stahl St. 37 / Steel

AK FER

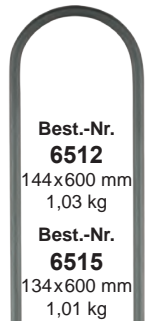

Best.-Nr.
6512
144x600 mm
1,03 kg

Best.-Nr.
6515
134x600 mm
1,01 kg

2,79 €/Stk./



Best.-Nr.
6513
144x1000 mm
1,75 kg

Best.-Nr.
6516
134x1000 mm
1,73 kg

3,89 €/Stk./



Best.-Nr.
6514
144x1500 mm
2,65 kg

Best.-Nr.
6517
134x1500 mm
2,63 kg

4,89 €/Stk./

Länge Longueur / Length /mm	Material Matériau / Material	Best.-Nr.	€/Stk./ pcs.
600	Ø12	6519	2,09
1000	Ø12	6520	2,79
1500	Ø12	6521	3,39
600	12 x 12	6522	2,49
1000	12 x 12	6523	3,39
1500	12 x 12	6524	4,19

Top

Kugel
Ø 12 mm

≥
2,09
€/Stk./pcs.

Nouveau - New
Neu



Best.-Nr.
6501
155 x 90 mm
0,38 kg

1,99 €/Stk./pcs.



Best.-Nr.
6500
190 x 100 mm
0,45 kg

2,09 €/Stk./pcs.



Best.-Nr.
6509
120 x 85 mm
0,30 kg

1,59 €/Stk./pcs.



Best.-Nr.
6510
160 x 100 mm
0,35 kg

1,79 €/Stk./pcs.



Best.-Nr.
6511
220 x 105 mm
0,38 kg

2,09 €/Stk./pcs.



Best.-Nr.
6502
165x60 mm
0,15 kg

1,59 €/Stk./pcs.



Best.-Nr.
6505
120 x 110 mm
0,23 kg

1,59 €/Stk./pcs.



Best.-Nr.
6504
130 x 100 mm
0,22 kg

1,59 €/Stk./pcs.



Best.-Nr.
6507
180 x 115 mm
0,35 kg

2,59 €/Stk./pcs.



Best.-Nr.
6508
155 x 100 mm
0,32 kg

2,29 €/Stk./pcs.



Best.-Nr.
6506
115x120 mm
0,24 kg

1,79 €/Stk./pcs.



Best.-Nr.
6503
215x90 mm
0,29 kg

2,29 €/Stk./pcs.

AK FER

U- Bunde / Colliers en U / U-Collars

Material 12 x 3 mm

Für / for / pour mm	Best.-Nr.	< 99 €/Stk./ pcs.	> 100 €/Stk./ pcs.
12 x 12	6021	0,14	0,12
18 x 12	6022	0,15	0,13
24 x 12	6023	0,16	0,14

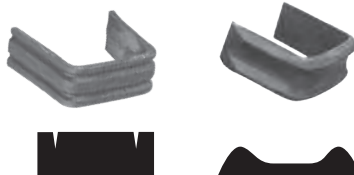

Material 16 x 3 mm

Für / for / pour mm	Best.-Nr.	< 99 €/Stk./ pcs.	> 100 €/Stk./ pcs.
12 x 12	6026	0,15	0,13
18 x 12	6027	0,16	0,14
24 x 12	6028	0,17	0,15
36 x 12	6029	0,18	0,16
16 x 16	6096	0,17	0,15
24 x 16	6097	0,18	0,16
32 x 16	6098	0,19	0,17

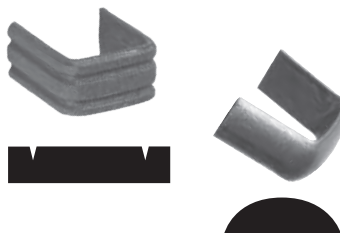

Material 12 x 3 mm, für/for/pour ● 12 mm

Für / for / pour mm	Best.-Nr.	< 99 €/Stk./ pcs.	> 100 €/Stk./ pcs.
24 x 12	6083	0,16	0,14
36 x 12	6084	0,18	0,16



AK FER

U-Bund überlappend

Colliers en U à rabattre / U-Collar overlapped Material 14 x 4 mm

Für / for / pour mm	Best.-Nr.	< 99 €/Stk./ pcs.	> 100 €/Stk./ pcs.
12 x 12	6080	0,23	0,19
18 x 12	6081	0,24	0,20
24 x 12	6082	0,25	0,21

Material 16 x 5 mm, für/for/pour ● 12 mm

Für / for / pour mm	Best.-Nr.	< 99 €/Stk./ pcs.	> 100 €/Stk./ pcs.
12 x 12	6090	0,21	0,19
18 x 12	6091	0,23	0,21
24 x 12	6092	0,24	0,22
36 x 12	6093	0,26	0,24
48 x 12	6094	0,28	0,26
60 x 12	6095	0,30	0,28

Achtung: Angabe der „Für Abmessung“
bezieht sich auf das zu bindende Material!

Material / Matériau / Material:
Schnörkel / Volutes / Scrolls: 12x6 mm
Stab / Barreau / Baluster: 12x12 mm

Länge / Longueur / Length: 900 mm

AK FER

Zierstäbe, glatt
Balustres, lisses / Ornamental balusters, plain edges

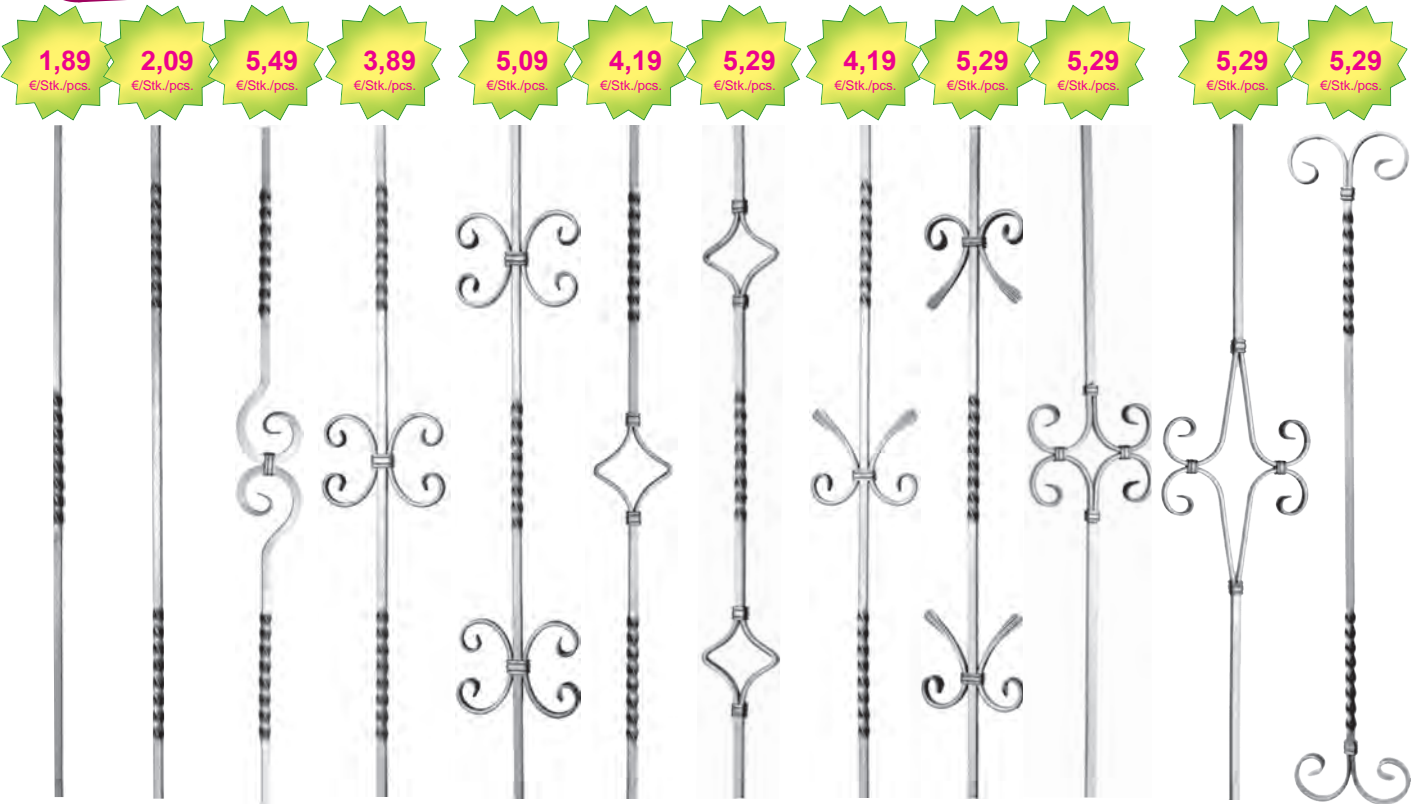

Best.-Nr. 5001 15 x 160 mm 1,00 kg	Best.-Nr. 5002 15 x 700 mm 0,99 kg	Best.-Nr. 5008 80 x 200 mm 1,30 kg	Best.-Nr. 5014 150 x 120 mm 1,36 kg	Best.-Nr. 5015 150 x 640 mm 1,67 kg	Best.-Nr. 5009 100 x 120 mm 1,06 kg	Best.-Nr. 5010 100 x 640 mm 1,16 kg	Best.-Nr. 5037 130 x 120 mm 1,24 kg	Best.-Nr. 5038 130 x 640 mm 1,52 kg	Best.-Nr. 5011 150 x 160 mm 1,31 kg	Best.-Nr. 5013 190 x 320 mm 1,34 kg	Best.-Nr. 5006 160 x 900 mm 1,33 kg
--	--	--	---	---	---	---	---	---	---	---	---



Best.-Nr. 5007 60 x 80 mm 1,06 kg	Best.-Nr. 5046 60 x 540 mm 1,13 kg	Best.-Nr. 5018 220 x 210 mm 1,69 kg	Best.-Nr. 5019 220x640 mm 2,45 kg	Best.-Nr. 5040 160 x 270 mm 1,59 kg	Best.-Nr. 5041 160 x 700 mm 2,17 kg	Best.-Nr. 5031 170 x 170 mm 1,53 kg	Best.-Nr. 5030 170 x 640 mm 1,98 kg	Best.-Nr. 5026 170 x 340 mm 2,00 kg	Best.-Nr. 5027 170 x 340 mm 2,00 kg
---	--	---	---	---	---	---	---	---	---

Stahl St. 37 / Steel

AK FER

Zierstäbe, glatt
Balustres, lisses / Ornamental balusters, plain edges



7,89 €/Stk./pcs.	7,89 €/Stk./pcs.	7,09 €/Stk./pcs.	12,59 €/Stk./pcs.	13,69 €/Stk./pcs.	7,09 €/Stk./pcs.	6,39 €/Stk./pcs.	6,39 €/Stk./pcs.
----------------------------	----------------------------	----------------------------	-----------------------------	-----------------------------	----------------------------	----------------------------	----------------------------

Best.-Nr. 5028 270 x 660 mm 2,75 kg	Best.-Nr. 5029 270 x 660 mm 2,75 kg	Best.-Nr. 5045 230 x 460 mm 2,49 kg	Best.-Nr. 5022 250 x 620 mm 2,64 kg	Best.-Nr. 5047 280 x 620 mm 3,42 kg	Best.-Nr. 5050 185 x 475 mm 2,32 kg	Best.-Nr. 5043 150 x 375 mm 1,53 kg	Best.-Nr. 5044 150 x 375 mm 1,77 kg
---	---	---	---	---	---	---	---



5,89 €/Stk./pcs.	6,19 €/Stk./pcs.	8,29 €/Stk./pcs.	5,99 €/Stk./pcs.	10,79 €/Stk./pcs.	7,49 €/Stk./pcs.	6,79 €/Stk./pcs.	5,29 €/Stk./pcs.
----------------------------	----------------------------	----------------------------	----------------------------	-----------------------------	----------------------------	----------------------------	----------------------------

Best.-Nr. 5051 150 x 250 mm 1,47 kg	Best.-Nr. 5039 185 x 360 mm 1,97 kg	Best.-Nr. 5023 250 x 540 mm 2,32 kg	Best.-Nr. 5017 250 x 340 mm 2,10 kg	Best.-Nr. 5021 250 x 450 mm 2,57 kg	Best.-Nr. 5016 250 x 450 mm 2,41 kg	Best.-Nr. 5024 250 x 300 mm 1,90 kg	Best.-Nr. 5012 180 x 320 mm 1,33 kg
---	---	---	---	---	---	---	---

Stahl St. 37 / Steel

E-mail: info@akbas-schmiedeeisen.de, www.akbas-schmiedeeisen.de

Tel: +49(0) 61 44 33 05-0, Fax: +49(0) 61 44 33 05-15

Tel: +33.3.68680131, E-mail: vente@akbas-schmiedeeisen.de, Tel: +44.151.6018946, E-mail: sales@akbas-schmiedeeisen.de

Material / Matériau / Material:
Schnörkel / Volutes / Scrolls: 12x6 mm
Stab / Barreau / Baluster: 12x12 mm

Länge / Longueur / Length: 900 mm

Zierstäbe, kantengehämmt
Balustres, Martelé / Ornamental balusters, Hammered edges

2,19
€/Stk./pcs.



Best.-Nr.
5101
15 x 160 mm
0,98 kg

2,59
€/Stk./pcs.



Best.-Nr.
5102
15 x 700 mm
0,98 kg

1,99
€/Stk./pcs.



Best.-Nr.
5100
12 x 900 mm
0,92 kg

5,49
€/Stk./pcs.



Best.-Nr.
5108
80 x 200 mm
1,14 kg

5,49
€/Stk./pcs.



Best.-Nr.
5130
170 x 640 mm
1,84 kg

4,39
€/Stk./pcs.



Best.-Nr.
5131
170 x 170 mm
1,34 kg

3,89
€/Stk./pcs.



Best.-Nr.
5114
150 x 120 mm
1,24 kg

5,09
€/Stk./pcs.



Best.-Nr.
5115
150 x 640 mm
1,61 kg

4,19
€/Stk./pcs.



Best.-Nr.
5109
100 x 120 mm
1,00 kg

5,29
€/Stk./pcs.



Best.-Nr.
5110
100 x 640 mm
1,06 kg

4,19
€/Stk./pcs.



Best.-Nr.
5137
130 x 120 mm
1,07 kg

5,29
€/Stk./pcs.



Best.-Nr.
5138
130 x 640 mm
1,34 kg

5,69
€/Stk./pcs.



Best.-Nr.
5146
60 x 540 mm
1,08 kg

4,29
€/Stk./pcs.



Best.-Nr.
5107
60 x 80 mm
0,96 kg

6,09
€/Stk./pcs.



Best.-Nr.
5151
150 x 250 mm
1,45 kg

7,49
€/Stk./pcs.



Best.-Nr.
5116
250 x 450 mm
2,34 kg

7,29
€/Stk./pcs.



Best.-Nr.
5145
230 x 460 mm
2,31 kg

10,79
€/Stk./pcs.



Best.-Nr.
5121
250 x 450 mm
2,47 kg

4,89
€/Stk./pcs.



Best.-Nr.
5140
160 x 270 mm
1,40 kg

7,09
€/Stk./pcs.



Best.-Nr.
5141
160 x 700 mm
1,96 kg

6,69
€/Stk./pcs.



Best.-Nr.
5143
150 x 375 mm
1,40 kg

6,39
€/Stk./pcs.



















Best.-Nr.
5144
150 x 375 mm
1,69 kg

Material / Matériau / Material:
Schnörkel / Volutes / Scrolls: 12x6 mm
Stab / Barreau / Baluster: 12x12 mm

Länge / Longueur / Length: 900 mm

Zierstäbe, kantengehämmt Balustres, Martelé / Ornamental balusters, Hammered edges

								
12,79 €/Stk./pcs.	7,09 €/Stk./pcs.	5,49 €/Stk./pcs.	5,49 €/Stk./pcs.	8,49 €/Stk./pcs.	8,09 €/Stk./pcs.	8,09 €/Stk./pcs.	13,69 €/Stk./pcs.	
Best.-Nr. 5122 250 x 620 mm 2,61 kg	Best.-Nr. 5119 220 x 640 mm 2,33 kg	Best.-Nr. 5126 170 x 340 mm 1,85 kg	Best.-Nr. 5127 170 x 340 mm 1,85 kg	Best.-Nr. 5123 250 x 540 mm 2,39 kg	Best.-Nr. 5129 270 x 660 mm 2,65 kg	Best.-Nr. 5128 270 x 660 mm 2,65 kg	Best.-Nr. 5147 280 x 620 mm 3,37 kg	
								
5,29 €/Stk./pcs.	5,29 €/Stk./pcs.	7,29 €/Stk./pcs.	5,99 €/Stk./pcs.	5,49 €/Stk./pcs.	5,59 €/Stk./pcs.	5,49 €/Stk./pcs.	6,19 €/Stk./pcs.	6,99 €/Stk./pcs.
Best.-Nr. 5106 160 x 900 mm 1,25 kg	Best.-Nr. 5118 220 x 210 mm 1,59 kg	Best.-Nr. 5150 185 x 475 mm 2,27 kg	Best.-Nr. 5117 250 x 340 mm 2,00 kg	Best.-Nr. 5113 190 x 320 mm 1,35 kg	Best.-Nr. 5112 180 x 320 mm 1,26 kg	Best.-Nr. 5111 150 x 160 mm 1,27 kg	Best.-Nr. 5139 185 x 360 mm 1,77 kg	Best.-Nr. 5124 250 x 300 mm 1,81 kg

Stahl St. 37 / Steel

E-mail: info@akbas-schmiedeeisen.de, www.akbas-schmiedeeisen.de

Tel: +49(0) 61 44 33 05-0, Fax: +49(0) 61 44 33 05-15

Tel: +33.3.68680131, E-mail: vente@akbas-schmiedeeisen.de Tel: +44.151.6018946, E-mail: sales@akbas-schmiedeeisen.de

AK FER

Leichtbarock- Zierstäbe, glatt
Balustres lisses baroque léger / Light Baroque balusters, plain edges

6,39
€/Stk./pcs.



Best.-Nr.
5206
180 x 340 mm
1,41 kg

6,39
€/Stk./pcs.



Best.-Nr.
5207
170 x 180 mm
1,34 kg

6,39
€/Stk./pcs.



Best.-Nr.
5205
195 x 320 mm
1,38 kg

4,89
€/Stk./pcs.



Best.-Nr.
5203
170 x 120 mm
1,39 kg

6,99
€/Stk./pcs.



Best.-Nr.
5204
170 x 640 mm
1,82 kg

9,09
€/Stk./pcs.



Best.-Nr.
5225
260 x 290 mm
1,92 kg

7,49
€/Stk./pcs.



Best.-Nr.
5210
170 x 410 mm
1,54 kg

8,09
€/Stk./pcs.



Best.-Nr.
5211
170 x 375 mm
1,88 kg

6,99
€/Stk./pcs.



Best.-Nr.
5224
170 x 900 mm
1,35 kg

10,19
€/Stk./pcs.



Best.-Nr.
5219
260 x 450 mm
2,59 kg

10,99
€/Stk./pcs.



Best.-Nr.
5218
250 x 530 mm
2,44 kg

13,39
€/Stk./pcs.

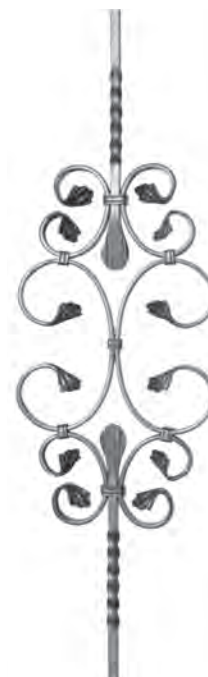











Best.-Nr.
5220
240 x 450 mm
2,31 kg

Material / Matériau / Material:
Schnörkel / Volutes / Scrolls: 12x6 mm
Stab / Barreau / Baluster: 12x12 mm

Länge / Longueur / Length: 900 mm

AK FER

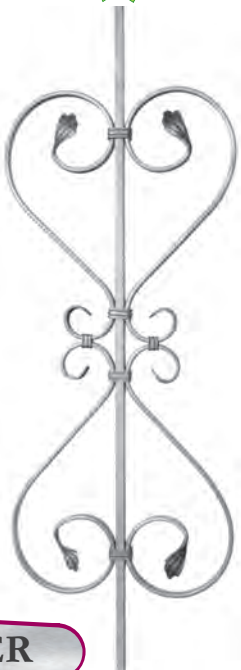
Leichtbarock-Zierstäbe, glatt
Balustres lisses baroque léger / Light Baroque balusters, plain edges

 <p>6,99 €/Stk./pcs.</p>	 <p>10,19 €/Stk./pcs.</p>	 <p>9,09 €/Stk./pcs.</p>	 <p>9,09 €/Stk./pcs.</p>	 <p>10,19 €/Stk./pcs.</p>	 <p>16,19 €/Stk./pcs.</p>
<p>Best.-Nr. 5208 220 x 220 mm 1,84 kg</p>	<p>Best.-Nr. 5209 220 x 640 mm 2,60 kg</p>	<p>Best.-Nr. 5214 250 x 340 mm 2,24 kg</p>	<p>Best.-Nr. 5212 210 x 460 mm 2,11 kg</p>	<p>Best.-Nr. 5213 240 x 460 mm 2,46 kg</p>	<p>Best.-Nr. 5201 280 x 620 mm 3,33 kg</p>
 <p>15,09 €/Stk./pcs.</p>	 <p>9,89 €/Stk./pcs.</p>	 <p>9,89 €/Stk./pcs.</p>	 <p>7,49 €/Stk./pcs.</p>	 <p>7,49 €/Stk./pcs.</p>	
<p>Best.-Nr. 5223 300 x 620 mm 3,23 kg</p>	<p>Best.-Nr. 5221 290 x 660 mm 2,70 kg</p>	<p>Best.-Nr. 5222 290 x 660 mm 2,70 kg</p>	<p>Best.-Nr. 5217 170 x 340 mm 1,95 kg</p>	<p>Best.-Nr. 5216 170 x 340 mm 1,95 kg</p>	

AK FER

Stahl St. 37 / Steel

E-mail: info@akbas-schmiedeeisen.de, www.akbas-schmiedeeisen.de

Tel: +49(0) 61 44 33 05-0, Fax: +49(0) 61 44 33 05-15

Tel: +33.3.68680131, E-mail: vente@akbas-schmiedeeisen.de, Tel: +44.151.6018946, E-mail: sales@akbas-schmiedeeisen.de

AK FER

Leichtbarock- Zierstäbe, kantengehämmt
Balustres baroque léger, martelées / Light Baroque balusters, hammered

1,99
€/Stk./pcs.



Best.-Nr. **5100**
12 x 900 mm
0,92 kg

2,19
€/Stk./pcs.



Best.-Nr. **5101**
15 x 160 mm
0,98 kg

2,59
€/Stk./pcs.



Best.-Nr. **5102**
15 x 700 mm
0,98 kg

9,39
€/Stk./pcs.



Best.-Nr. **5325**
260 x 290 mm
1,84 kg

9,09
€/Stk./pcs.



Best.-Nr. **5314**
250 x 340 mm
2,20 kg

7,49
€/Stk./pcs.



Best.-Nr. **5316**
170 x 340 mm
1,85 kg

7,49
€/Stk./pcs.



Best.-Nr. **5317**
170 x 340 mm
1,79 kg

10,19
€/Stk./pcs.



Best.-Nr. **5313**
240 x 460 mm
2,32 kg

13,39
€/Stk./pcs.

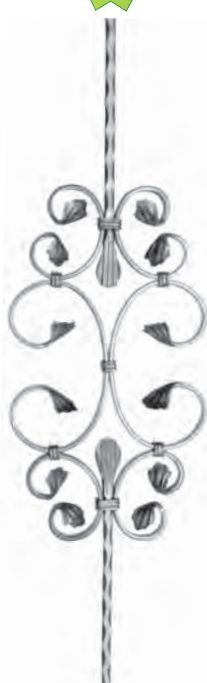

Best.-Nr. **5320**
240 x 450 mm
2,28 kg

10,09
€/Stk./pcs.



Best.-Nr. **5321**
290 x 660 mm
2,70 kg

10,09
€/Stk./pcs.

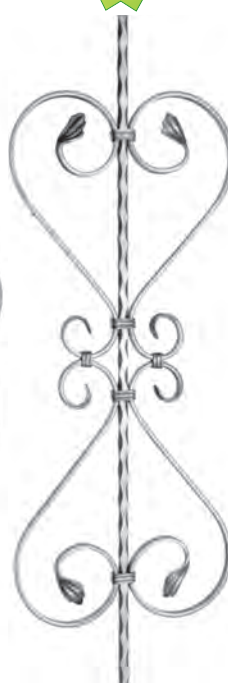

Best.-Nr. **5322**
290 x 660 mm
2,70 kg

14,39
€/Stk./pcs.



Best.-Nr. **5323**
300 x 620 mm
3,28 kg

16,19
€/Stk./pcs.



Best.-Nr. **5301**
280 x 620 mm
3,27 kg

AK FER

Leichtbarock- Zierstäbe, kantengehämmt
Balustres baroque léger, martelées / Light Baroque balusters, hammered



10,19
€/Stk./pcs.

Best.-Nr.
5319
260 x 450 mm
2,47 kg



6,69
€/Stk./pcs.

Best.-Nr.
5305
195 x 320 mm
1,35 kg



6,69
€/Stk./pcs.

Best.-Nr.
5306
180 x 340 mm
1,29 kg



11,19
€/Stk./pcs.

Best.-Nr.
5318
250 x 340 mm
2,45 kg



4,89
€/Stk./pcs.

Best.-Nr.
5303
170 x 120 mm
1,27 kg



6,99
€/Stk./pcs.

Best.-Nr.
5304
170 x 640 mm
1,66 kg



7,69
€/Stk./pcs.

Best.-Nr.
5310
170 x 375 mm
1,47 kg



8,09
€/Stk./pcs.

Best.-Nr.
5311
170 x 375 mm
1,83 kg



6,99
€/Stk./pcs.

Best.-Nr.
5308
220 x 220 mm
1,70 kg



10,19
€/Stk./pcs.

Best.-Nr.
5309
220 x 640 mm
2,68 kg



9,09
€/Stk./pcs.

Best.-Nr.
5312
210 x 400 mm
2,05 kg



6,39
€/Stk./pcs.

Best.-Nr.
5307
170 x 180 mm
1,29 kg



6,99
€/Stk./pcs.

Best.-Nr.
5324
170 x 900 mm
1,25 kg

E-mail: info@akbas-schmiedeeisen.de, www.akbas-schmiedeeisen.de

Tel: +49(0) 61 44 33 05-0, Fax: +49(0) 61 44 33 05-15

Tel: +33.3.68680131, E-mail: vente@akbas-schmiedeeisen.de, Tel: +44.151.6018946, E-mail: sales@akbas-schmiedeeisen.de

Länge / Longueur / Length: 1000 mm

2,39
€/Stk./pcs.



Best.-Nr.
5442
12x12 mm
1,10kg

5,89
€/Stk./pcs.



Best.-Nr.
5406
12x12 mm
1,80 kg

Detail der
Ausschmiedung
Ø 30 mm



5,89
€/Stk./pcs.



Best.-Nr.
5411
12x12 mm
1,95 kg

Detail der
Ausschmiedung
30x30 mm



5,89
€/Stk./pcs.



Best.-Nr.
5435
ø 12 mm
1,10 kg

4,69
€/Stk./pcs.



Best.-Nr.
5418
ø 14 mm
1,30 kg

3,19
€/Stk./pcs.



Best.-Nr.
5414
ø 14 mm
1,20 kg

4,49
€/Stk./pcs.



Best.-Nr.
5413
12x12 mm
1,10 kg

4,59
€/Stk./pcs.



Best.-Nr.
5401
12x12 mm
1,50kg

Detail der
Ausschmiedung
Ø 30 mm



4,59
€/Stk./pcs.



Best.-Nr.
5410
12x12 mm
1,55 kg

Detail der
Ausschmiedung
30x30 mm



4,59
€/Stk./pcs.



Best.-Nr.
5434
ø 12 mm
1,06 kg

3,49
€/Stk./pcs.



Best.-Nr.
5417
ø 14 mm
1,25 kg

2,89
€/Stk./pcs.



Best.-Nr.
5415
ø 14 mm
1,20 kg

3,39
€/Stk./pcs.



Best.-Nr.
5412
12x12 mm
1,10 kg

AK FER

**Schmiedestäbe
Balustres forgés / Forged balusters**

Länge / Longueur / Length: 1000 mm

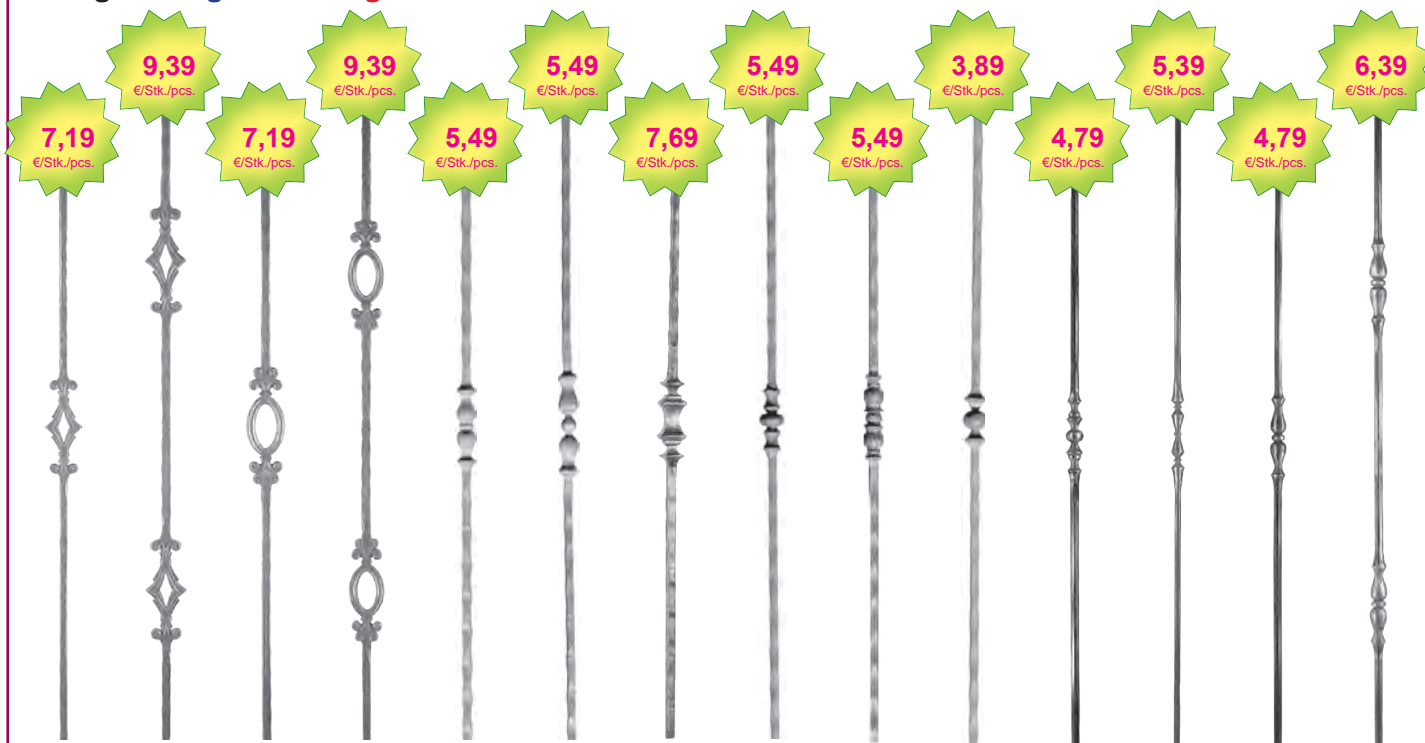

Best.-Nr. 5421 14 x 14 mm 1,65 kg	Best.-Nr. 5425 14x14 mm 1,80 kg	Best.-Nr. 5422 14x14 mm 1,65 kg	Best.-Nr. 5428 14x14 mm 1,80 kg	Best.-Nr. 5400 12x12 mm 1,30 kg	Best.-Nr. 5402 12x12 mm 1,65 kg	Best.-Nr. 5436 14x14 mm 2,11 kg	Best.-Nr. 5404 12x12 mm 1,55 kg	Best.-Nr. 5408 12x12 mm 1,70 kg	Best.-Nr. 5409 13 x 13 mm 1,24 kg	Best.-Nr. 5485 ø 12 mm 1,14 kg	Best.-Nr. 5486 ø 12 mm 1,18 kg	Best.-Nr. 5489 ø 12 mm 1,14 kg	Best.-Nr. 5490 ø 12 mm 1,28 kg
7,19 €/Stk./pcs.	9,39 €/Stk./pcs.	7,19 €/Stk./pcs.	9,39 €/Stk./pcs.	5,49 €/Stk./pcs.	5,49 €/Stk./pcs.	7,69 €/Stk./pcs.	5,49 €/Stk./pcs.	3,89 €/Stk./pcs.	4,79 €/Stk./pcs.	5,39 €/Stk./pcs.	4,79 €/Stk./pcs.	6,39 €/Stk./pcs.	

Länge / Longueur / Length: 1000 mm

AK FER



Best.-Nr. 5416 14x14 mm 1,50 kg	Best.-Nr. 5430 12x12 mm kantengeh. 1,00 kg	Best.-Nr. 5431 12x12 mm kantengeh. 1,00 kg	Best.-Nr. 5440 ø 14 mm gehämmert 1,08 kg	Best.-Nr. 5441 ø 14 mm gehämmert 1,08 kg	Best.-Nr. 5423 12x12 mm 1,00 kg	Best.-Nr. 5424 12x12 mm 1,00 kg	Best.-Nr. 5426 ø 12 mm 0,80 kg	Best.-Nr. 5427 ø 12 mm 0,80 kg	Best.-Nr. 5487 12x12 mm 1,13 kg	Best.-Nr. 5488 12x12 mm 1,13 kg	Best.-Nr. 5439 12x12 mm 2,01 kg	Best.-Nr. 5420 12x12 mm kantengeh. 1,00 kg	Best.-Nr. 5437 12x12 mm kantengeh. 1,27 kg
7,19 €/Stk./pcs.	3,09 €/Stk./pcs.	3,69 €/Stk./pcs.	3,59 €/Stk./pcs.	3,49 €/Stk./pcs.	3,29 €/Stk./pcs.	2,89 €/Stk./pcs.	2,79 €/Stk./pcs.	3,19 €/Stk./pcs.	3,89 €/Stk./pcs.	4,79 €/Stk./pcs.	18,79 €/Stk./pcs.	3,19 €/Stk./pcs.	8,29 €/Stk./pcs.

E-mail: info@akbas-schmiedeeisen.de, www.akbas-schmiedeeisen.de

Tel: +49(0) 61 44 33 05-0, Fax: +49(0) 61 44 33 05-15

Tel: +33.3.68680131, E-mail: vente@akbas-schmiedeeisen.de, Tel: +44.151.6018946, E-mail: sales@akbas-schmiedeeisen.de

Länge / Longueur / Length: 1200 mm

						
7,49 €/Stk./pcs.	9,69 €/Stk./pcs.	8,59 €/Stk./pcs.	10,79 €/Stk./pcs.	10,79 €/Stk./pcs.	16,19 €/Stk./pcs.	19,39 €/Stk./pcs.
						
15,09 €/Stk./pcs.	19,39 €/Stk./pcs.	15,09 €/Stk./pcs.	18,29 €/Stk./pcs.	19,39 €/Stk./pcs.	19,39 €/Stk./pcs.	
Best.-Nr. 8001 20 x 20 mm 3,79 kg	Best.-Nr. 8006 20 x 20 mm 4,07 kg	Best.-Nr. 8003 20 x 20 mm kantengehämmert 3,67 kg	Best.-Nr. 8008 20 x 20 mm 4,12 kg	Best.-Nr. 8009 20 x 20 mm kantengehämmert 3,79 kg	Best.-Nr. 8017 25 x 25 mm kantengehämmert 5,90 kg	Best.-Nr. 8015 25 x 25 mm 7,30 kg
Best.-Nr. 8019 25 x 25 mm 5,90 kg	Best.-Nr. 8016 25 x 25 mm 6,70 kg	Best.-Nr. 8020 ø 25 mm 4,60 kg	Best.-Nr. 8021 25 x 25 mm 4,70 kg	Best.-Nr. 8022 ø 25 mm 5,92 kg	Best.-Nr. 8023 ø 25 mm 5,49 kg	

AK FER

Stangenmaterial Barreaux divers / Bar stock

Vierkanteisen, kantengehämmert
Barreaux quadrangulaires, martelés
Square steel bar, hammered edges

Länge / Longueur / Length: 3000 mm

≥ 1,79 €/m



Abmessung	kg/m	Best.-Nr.	€/m
12 mm	1,05	11001	1,79
14 mm	1,42	11004	2,39
16 mm	1,85	11002	3,19
20 mm	2,92	11003	5,09
25 mm	4,56	11005	7,49

Vierkantrrohr, kantengehämmert
Tubes quadrangulaires, martelés
Rectangle tubes, hammered edges

≥ 2,59 €/m

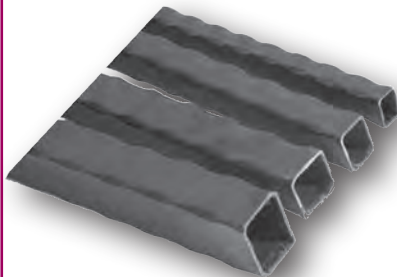

Spießkantig abgehämmert, somit absolut keine scharfen Kanten!
Tubes quadrangulaires : Bords adoucis!
Rectangle tubes: No sharp edges!

AK FER

Länge / Longueur / Length: 3000 mm

Abmessungen / Mesure	kg/m	Best.-Nr.	€/m
20 x 20 x 2,0 mm	1,00	11500	2,59
25 x 25 x 2,0 mm	1,33	11511	3,19
30 x 20 x 2,0 mm	1,33	11501	3,19
30 x 30 x 2,5 mm	2,10	11502	3,99
40 x 20 x 2,5 mm	2,10	11503	3,99
40 x 30 x 2,5 mm	2,33	11504	4,79
40 x 40 x 2,5 mm	2,83	11505	5,39
50 x 30 x 2,5 mm	2,83	11506	5,39
60 x 40 x 2,5 mm	3,77	11507	6,99
60 x 60 x 2,5 mm	5,30	11508	9,89
80 x 80 x 3,0 mm	7,00	11509	13,69
100 x 100 x 3,5 mm	8,60	11510	17,19

Bundeisen und Stangenware Colliers et barreaux / Collars and bars

	Länge Longueur Length	Abmessung Dimension Dimension	Best.-Nr.	€/m
Bundeisen	2500 mm	12 x 3 mm	11300	0,91
Bundeisen	2500 mm	16 x 3 mm	11301	1,02
Bundeisen	3000 mm	13 x 3 mm	11302	1,07
Bundeisen	4000 mm	16 x 5 mm	11303	1,18
Vierkanteisen, gerillt 1,05 kg/m	3000 mm	12 x 12 mm	11202	2,15
Flacheisen beidseitig gerillt 0,94 kg/m	3000 mm	16 x 8 mm	11201	2,15
Flacheisen beidseitig abgehämmert 0,92 kg/m	3000 mm	16 x 8 mm	11101	2,15
Flacheisen, gerillt, beidseitig abgehämmert 2,18 kg/m	3000 mm	30 x 10 mm	11102	4,85

Handlauf Main courante / Handrail

Länge / Longueur / Length:
3000 mm

	Abmessung Dimension Dimension	kg/m	Best.-Nr.	€/m
Gerillt Rainure sur la tranche Grooved	40 x 8 mm	2,05	7030	4,31
	30 x 8 mm	1,77	7003	3,77
	40 x 8 mm	2,35	7004	4,09
	50 x 5 mm	1,83	11011	4,85
	50 x 8 mm	2,93	7036	5,39
	20 x 8 mm	1,18	7001	2,47
	25 x 8 mm	1,47	7028	2,99
	40 x 5 mm	1,46	11010	3,77
	40 x 8 mm	2,35	7002	4,09

≥ 2,25 €/m



Nouveau - New
Neu

Hespeneisen / U-Fer / U-Iron

Länge Longueur / Length /mm	Material Matériau / Material	Best.-Nr.	€/m
3000	25 x 8 mm	11012	2,25
3000	30 x 8 mm	11013	2,45
3000	40 x 8 mm	11014	4,29

E-mail: info@akbas-schmiedeeisen.de, www.akbas-schmiedeeisen.de

Tel: +49(0) 61 44 33 05-0, Fax: +49(0) 61 44 33 05-15

Tel: +33.3.68680131, E-mail: vente@akbas-schmiedeeisen.de, Tel: +44.151.6018946, E-mail: sales@akbas-schmiedeeisen.de



Handlaufzubehör ohne Rillen

Accessoires de main-courante sans rainure / Handrail accessories, not grooved



Handlauf-Anfang
Best.-Nr. 7017
400 x 150 mm
1,65 kg

7,49 €/Stk./pcs.



Handlauf-Anfang
Best.-Nr. 7006
730 x 150 mm
2,20 kg

7,99 €/Stk./pcs.



Handlauf-Anfang
Best.-Nr. 7016
750 x 320 mm
2,30 kg

9,99 €/Stk./pcs.



Krümmer
290 x 290 mm
Best.-Nr. 7008
20 x 8 mm, 0,60 kg

2,99 €/Stk./pcs.



Handlauf-Anfang
Best.-Nr. 7007
250 x 115 mm
Aus 40 x 8 mm,
0,90 kg

6,99 €/Stk./pcs.



Handlauf-Anfang
Best.-Nr. 7026
140 x 60 mm
Aus 40 x 8 mm,
0,47 kg

3,09 €/Stk./pcs.

Best.-Nr. 7029
25 x 8 mm, 0,75 kg

3,29 €/Stk./pcs.

Best.-Nr. 7009
40 x 8 mm, 1,20 kg

3,79 €/Stk./pcs.

Handlaufzubehör mit Rillen

Accessoire de main-courante avec rainure / Grooved handrail termination



Handlauf-Anfang
Best.-Nr. 7019
400 x 150 mm
1,65 kg

8,09 €/Stk./pcs.



Handlauf-Anfang
Best.-Nr. 7018
750 x 320 mm
2,30 kg

10,79 €/Stk./pcs.



Handlauf-Anfang
Best.-Nr. 7010
Aus 40 x 8 mm
730 x 150 mm, 2,20 kg

8,59 €/Stk./pcs.

Best.-Nr. 7038
Aus 50 x 8 mm
730 x 150 mm, 2,75 kg

10,79 €/Stk./pcs.



Handlauf-Anfang
250 x 115 mm
Best.-Nr. 7011
Aus 40 x 8 mm,
0,90 kg

7,49 €/Stk./pcs.

Best.-Nr. 7037
Aus 50 x 8 mm,
1,13 kg

8,59 €/Stk./pcs.

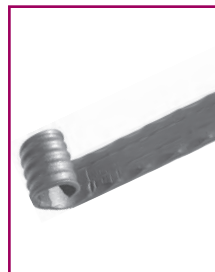

Handlauf-Ende
140 x 60 mm
Best.-Nr. 7027
Aus 40 x 8 mm,
0,47 kg

3,29 €/Stk./pcs.

Best.-Nr. 7035
Aus 50 x 8 mm,
0,60 kg

3,99 €/Stk./pcs.



Krümmer
290 x 290 mm
Best.-Nr. 7013
Aus 30 x 8 mm,
0,9 kg

3,49 €/Stk./pcs.

Best.-Nr. 7014
Aus 40 x 8 mm,
1,20 kg

4,09 €/Stk./pcs.

Handlaufzubehör mit Rillen

Accessoire de main-courante avec rainure

Grooved handrail termination



Handlauf-Anfang
Best.-Nr. 7031
250 x 115 mm
0,80 kg

7,49 €/Stk./pcs.



Krümmer
Best.-Nr. 7033
Aus 40 x 8 mm
290 x 290 mm
1,06 kg

3,99 €/Stk./pcs.



Handlauf-Anfang
Best.-Nr. 7032
730 x 150 mm
1,94 kg

8,59 €/Stk./pcs.

Handlaufzubehör

Support de main-courante / Handrail bracket

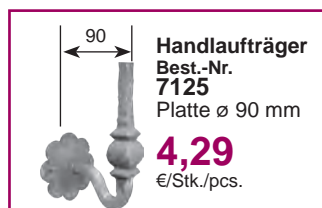

Handlaufträger
Best.-Nr. 7125
Platte ø 90 mm

4,29 €/Stk./pcs.



Handlaufträger
Best.-Nr. 7126
Platte ø 90 mm

4,29 €/Stk./pcs.



Handlaufträger
Best.-Nr. 7122
110 x 190 mm
0,52 kg

4,89 €/Stk./pcs.

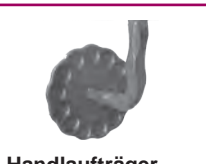

Handlaufträger
Best.-Nr. 7123
gehämmert / martelé
hammered / martellato
ø 80 mm

2,99 €/Stk./pcs.



Handlaufträger
Best.-Nr. 7124
gehämmert / martelé
hammered / martellato
ø 80 mm

3,19 €/Stk./pcs.

AK FER

Korbstäbe / Barreaux galbés / Convex bars



Korbstab aus 12x12 mm
glatt / lisse / plain
Ausbauchung / Renflement / Belly 180 mm

Länge/mm	Best.-Nr.	€/Stk./pcs.
900	4001	2,99
1350	4002	4,19
1500	4003	4,69

≥ 2,99 €/Stk./pcs.

Korbstab aus 12x12 mm
gehämmert / martelé / hammered
Ausbauchung / Renflement / Belly 180 mm

Länge/mm	Best.-Nr.	€/Stk./pcs.
900	4101	3,19
1350	4102	4,59
1500	4103	4,99



Korbstab aus 12x12 mm
glatt / lisse / plain
Ausbauchung / Renflement / Belly 180 mm

Länge/mm	Best.-Nr.	€/Stk./pcs.
900	4016	3,09
1350	4017	4,29
1500	4018	4,79

≥ 3,09 €/Stk./pcs.

Korbstab aus 12x12 mm
gehämmert / martelé / hammered
Ausbauchung / Renflement / Belly 180 mm

Länge/mm	Best.-Nr.	€/Stk./pcs.
900	4116	3,49
1350	4117	4,79
1500	4118	5,39



Korbstab aus 12x12 mm
glatt / lisse / plain
Ausbauchung / Renflement / Belly 180 mm

Länge/mm	Best.-Nr.	€/Stk./pcs.
900	4022	4,89
1350	4023	6,19
1500	4024	6,79

≥ 4,89 €/Stk./pcs.

Korbstab aus 12x12 mm
gehämmert / martelé / hammered
Ausbauchung / Renflement / Belly 180 mm

Länge/mm	Best.-Nr.	€/Stk./pcs.
900	4122	5,49
1350	4123	6,89
1500	4124	7,39



Korbstab aus 12x12 mm
glatt / lisse / plain
Ausbauchung / Renflement / Belly 180 mm

Länge/mm	Best.-Nr.	€/Stk./pcs.
900	4028	4,89
1350	4029	6,19
1500	4030	6,79

≥ 4,89 €/Stk./pcs.

Korbstab aus 12x12 mm
gehämmert / martelé / hammered
Ausbauchung / Renflement / Belly 180 mm

Länge/mm	Best.-Nr.	€/Stk./pcs.
900	4128	5,49
1350	4129	6,89
1500	4130	7,39



Korbstab aus 12x12 mm
glatt / lisse / plain
Ausbauchung / Renflement / Belly 200 mm

Länge/mm	Best.-Nr.	€/Stk./pcs.
1000	4050	3,19
1350	4051	4,29
1500	4052	4,89

≥ 3,19 €/Stk./pcs.

Korbstab aus 12x12 mm
gehämmert / martelé / hammered
Ausbauchung / Renflement / Belly 200 mm

Länge/mm	Best.-Nr.	€/Stk./pcs.
1000	4150	3,49
1350	4151	4,79
1500	4152	5,39



Korbstab aus 12x12 mm
glatt / lisse / plain
Ausbauchung / Renflement / Belly 130 mm

Länge/mm	Best.-Nr.	€/Stk./pcs.
900	4031	2,99
1350	4032	4,09
1500	4033	4,59

≥ 2,99 €/Stk./pcs.

Korbstab aus ø 12 mm
glatt / lisse / plain
Ausbauchung / Renflement / Belly / 130 mm

Länge/mm	Best.-Nr.	€/Stk./pcs.
900	5553	2,99
1350	5554	3,99
1500	5555	4,49



Korbstab aus 12x12 mm
glatt / lisse / plain
Ausbauchung / Renflement / Belly 180 mm

Länge/mm	Best.-Nr.	€/Stk./pcs.
900	4013	3,69
1350	4014	4,79
1500	4015	5,39

≥ 3,69 €/Stk./pcs.



Korbstab aus 12x12 mm
glatt / lisse / plain
Ausbauchung / Renflement / Belly 180 mm

Länge/mm	Best.-Nr.	€/Stk./pcs.
900	4004	3,49
1350	4005	4,59
1500	4006	4,99

≥ 3,49 €/Stk./pcs.

AK FER

E-mail: info@akbas-schmiedeeisen.de, www.akbas-schmiedeeisen.de

Tel: +49(0) 61 44 33 05-0, Fax: +49(0) 61 44 33 05-15

Tel: +33.3.68680131, E-mail: vente@akbas-schmiedeeisen.de, Tel: +44.151.6018946, E-mail: sales@akbas-schmiedeeisen.de

AK FER

Korbstäbe & Zubehör Barreaux galbés et accessoires / Convex bars & Accessories

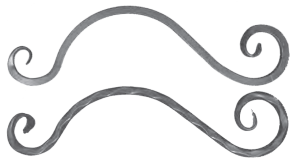

Korbstab aus 12x12 mm
Ausbauchung
Renflement / Belly 110 mm
*gehämmert / martelé / hammered

	Best.-Nr.	€/Stk./pcs.
glatt	4060	3,69
*	4160	4,29



Best.-Nr. 4075
Aus 25 x 8 mm
900 mm
4,39 €/Stk./pcs.



Best.-Nr. 4070
Aus 12 x 12 mm
900 mm
4,19 €/Stk./pcs.



Best.-Nr. 4071
Aus 14 x 14 mm
900 mm
4,69 €/Stk.

Best.-Nr. 4072
Aus 14 x 14 mm
1500 mm
6,99 €/Stk.



Best.-Nr. 4073
Aus 14 x 14 mm
900 mm
9,69 €/Stk..

Best.-Nr. 4074
Aus 14 x 14 mm
1500 mm
11,39 €/Stk.



Best.-Nr. 6174
Aus 14 x 14 mm
70x140 mm
gehämmert
martelé
hammered
1,89 €/Stk./pcs.



Best.-Nr. 6074
Aus 14 x 14 mm
70x140 mm
glatt
lisse
plain
1,89 €/Stk./pcs.



Best.-Nr. 6077
Aus 14 x 14 mm
70x140 mm
2,79 €/Stk./pcs.



Best.-Nr. 6076
Aus 30x8 mm
70 x 100 mm
1,79 €/Stk./pcs.



Best.-Nr. 6175
45 x 135 mm, Mat. 10 mm
2,99 €/Stk./pcs.

Best.-Nr. 6176
60 x 175 mm, Mat. 10 mm
3,69 €/Stk./pcs.



Best.-Nr. 6075
Aus 40x8 mm, 70 x 100 mm
Gerillt / Rainure sur la tranche
Grooved
1,89 €/Stk./pcs.

Best.-Nr. 6099
Aus 40x8 mm, 70 x 100 mm
ohne Rillen / sans rainure
not grooved
1,89 €/Stk./pcs.

Locheisen / Barreaux avec trous forgés / Bars with holes ca. 2000 mm, 14 Loch/Stange / ca. 2000 mm, 14 Trous/Barre / approx. 2000 mm, 14 Hole/Bar

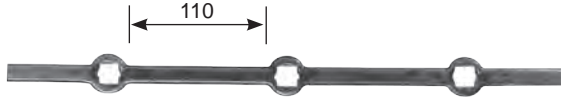

Best.-Nr. 11410-14 ■ 14 mm, Lochung □ 14 mm **5,39** €/m
Best.-Nr. 11410-20 ■ 20 mm, Lochung □ 20 mm **8,59** €/m

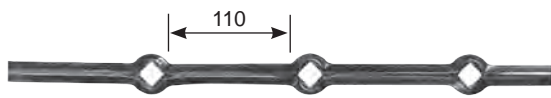

Best.-Nr. 11412-14 ◆ 14 mm, Lochung □ 14 mm **5,39** €/m
Best.-Nr. 11412-20 ◆ 20 mm, Lochung □ 20 mm **8,59** €/m

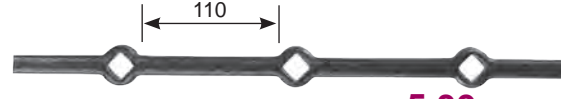

Best.-Nr. 11411-14 ■ 14 mm, Lochung □ 14 mm **5,39** €/m
Best.-Nr. 11411-20 ■ 20 mm, Lochung □ 20 mm **8,59** €/m



Best.-Nr. 11413-14 ● 14 mm, Lochung ○ 14 mm **5,39** €/m
Best.-Nr. 11413-20 ● 20 mm, Lochung ○ 20 mm **8,59** €/m



Best.-Nr. 9020
Aus ø 12 mm

Best.-Nr. 9021
Aus ■ 12 x 12 mm

Best.-Nr. 9022
Aus ■ 12 x 12 mm
gehämmert
martelé
hammered
35 x 175 mm
0,96 €/Stk./pcs.



Best.-Nr. 9016
Aus ø 12 mm

Best.-Nr. 9017
Aus ■ 12 x 12 mm

Best.-Nr. 9023
Aus ■ 12 x 12 mm
gehämmert
martelé
hammered
35 x 150 mm
1,07 €/Stk./pcs.



Best.-Nr. 9001
Aus ø 12 mm

Best.-Nr. 9002
Aus ■ 12 x 12 mm

Best.-Nr. 9003
Aus ■ 12 x 12 mm
gehämmert
martelé
hammered
35 x 150 mm
0,96 €/Stk./pcs.









Best.-Nr. 9018
Aus ø 12 mm







Best.-Nr. 9019
Aus ■ 12 x 12 mm

Best.-Nr. 9024
Aus ■ 12 x 12 mm
gehämmert
martelé
hammered
35 x 150 mm
0,96 €/Stk./pcs.

AK FER

Zierspitzen & Lanzenstäbe Fers de lance / Spears & Lance Bars

 <p>Best.-Nr. 9014 ■ 24 mm 30 x 125 mm 0,64 €/Stk./pcs.</p>	 <p>Best.-Nr. 9011 ∅ 30 mm 35 x 120 mm 0,64 €/Stk./pcs.</p>	 <p>Best.-Nr. 9025 ∅ 20 mm 70 x 125 mm 0,64 €/Stk./pcs.</p>	 <p>Best.-Nr. 9005 60 x 125 mm 0,64 €/Stk./pcs.</p> <p>∅ 20 mm ∅ 13 mm</p>	 <p>Best.-Nr. 9008 60 x 125 mm 0,64 €/Stk./pcs.</p> <p>∅ 20 mm ∅ 13 mm</p>	 <p>Best.-Nr. 9029 50 x 150 mm 1,29 €/Stk./pcs.</p>
--	--	--	--	---	--

 <p>Best.-Nr. 9015 ■ 32 mm 165 mm 1,69 €/Stk./pcs.</p>	 <p>Best.-Nr. 9012 ∅ 33 mm 40 x 150 mm 1,39 €/Stk./pcs.</p>	 <p>Best.-Nr. 9026 ∅ 25 mm 90 x 160 mm 1,29 €/Stk./pcs.</p>	 <p>Best.-Nr. 9006 70 x 160 mm 1,07 €/Stk./pcs.</p> <p>∅ 25 mm ∅ 17 mm</p>	 <p>Best.-Nr. 9009 70 x 160 mm 1,07 €/Stk./pcs.</p> <p>∅ 25 mm ∅ 17 mm</p>	 <p>Best.-Nr. 9028 60 x 175 mm 1,49 €/Stk./pcs.</p>	 <p>Best.-Nr. 9027 65 x 200 mm 2,15 €/Stk./pcs.</p>
--	---	---	--	--	---	---

≥ 3,29 €/Stk./pcs.

Material /mm	Höhe /cm	Best.-Nr.	€/Stk./pcs.
∅ 12	100	9301	3,29
∅ 12	150	9302	3,79
■ 12 x 12	100	9303	3,29
■ 12 x 12	150	9304	3,79
■ 12 x 12 *	100	9305	3,79
■ 12 x 12 *	150	9306	4,29

*gehämmert / martelé / hammered

≥ 3,45 €/Stk./pcs.

Material /mm	Höhe /cm	Best.-Nr.	€/Stk./pcs.
∅ 12	100	9307	3,45
∅ 12	150	9308	4,05
■ 12 x 12	100	9309	3,45
■ 12 x 12	150	9310	4,05
■ 12 x 12 *	100	9323	3,99
■ 12 x 12 *	150	9324	4,59

*gehämmert / martelé / hammered

≥ 3,29 €/Stk./pcs.

Material /mm	Höhe /cm	Best.-Nr.	€/Stk./pcs.
∅ 12	100	9311	3,29
∅ 12	150	9312	3,79
■ 12 x 12	100	9313	3,29
■ 12 x 12	150	9314	3,79
■ 12 x 12 *	100	9315	3,79
■ 12 x 12 *	150	9316	4,29

*gehämmert / martelé / hammered

≥ 3,29 €/Stk./pcs.

Material /mm	Höhe /cm	Best.-Nr.	€/Stk./pcs.
∅ 12	100	9317	3,29
∅ 12	150	9318	3,79
■ 12 x 12	100	9319	3,29
■ 12 x 12	150	9320	3,79
■ 12 x 12 *	100	9321	3,79
■ 12 x 12 *	150	9322	4,29

*gehämmert / martelé / hammered

E-mail: info@akbas-schmiedeeisen.de, www.akbas-schmiedeeisen.de

Tel: +49(0) 61 44 33 05-0, Fax: +49(0) 61 44 33 05-15

Tel: +33.3.68680131, E-mail: vente@akbas-schmiedeeisen.de, Tel: +44.151.6018946, E-mail: sales@akbas-schmiedeeisen.de

AK FER

Rosetten / Rosettes forgées / Forged rosettes

65 x 65 mm, Material 4 mm	Best.-Nr.	€/Stk./ pcs.
ohne Loch	10809	0,85
mit Loch 12x12 mm	10810	0,85
mit Loch 16x16 mm	10811	0,85
mit Loch 20x20 mm	10812	0,85



0,85
€/Stk./pcs.

ø 80 mm, Material 4 mm	Best.-Nr.	€/Stk./ pcs.
ohne Loch	10823	0,95
mit Loch 12x12 mm	10824	0,95
mit Loch 16x16 mm	10825	0,95
mit Loch 20x20 mm	10826	0,95
mit Loch 24x24 mm	10827	0,95



0,95
€/Stk./pcs.

80x80 mm, Material 4 mm	Best.-Nr.	€/Stk./ pcs.
ohne Loch	10813	1,05
mit Loch 12x12 mm	10814	1,05
mit Loch 16x16 mm	10815	1,05
mit Loch 20x20 mm	10816	1,05
mit Loch 24x24 mm	10817	1,05



≥ 1,05
€/Stk./pcs.

100 x 100 mm, Material 6 mm	Best.-Nr.	€/Stk./ pcs.
ohne Loch	10818	2,15



100 x 100 mm, Material 8 mm	Best.-Nr.	€/Stk./ pcs.
ohne Loch	10819	2,35

Best.-Nr. 10829	Best.-Nr. 10828	Best.-Nr. 10831	Best.-Nr. 10830
ø 65 mm	ø 65 mm	ø 130 mm	ø 80 mm
Material 3 mm	Material 3 mm	Material 4 mm	Material 2,5 mm
0,85 €/Stk./pcs.	0,85 €/Stk./pcs.	3,29 €/Stk./pcs.	1,39 €/Stk./pcs.

AK FER

Schmiedestücke & Zierteile Accessoires en fer forgé / Forgings & Accessories

Best.-Nr.
6013
Aus 12 x 12 mm
glatt
lisse
plain
Länge 290 mm
0,95 €/Stk./pcs.

Best.-Nr.
6113
Aus 12 x 12 mm
gehämmert
martelé
hammered
Länge 290 mm
0,95 €/Stk./pcs.

Best.-Nr.
9201
ø 12 mm rund
1,89 €/Stk./pcs.

Best.-Nr.
9202
1,89 €/Stk./pcs.

Best.-Nr.
9203
1,89 €/Stk./pcs.

Best.-Nr.
9204
1,89 €/Stk./pcs.

Best.-Nr.
9205
1,89 €/Stk./pcs.

Best.-Nr.
6014
Aus 12 x 12 mm
glatt
lisse / plain
55 x 100 mm
1,05 €/Stk./pcs.

Best.-Nr.
6114
Aus 12 x 12 mm
gehämmert
martelé / hammered
55 x 100 mm
1,05 €/Stk./pcs.

Best.-Nr. **9214**
Lochung ø 12,5 mm, ø 35 x 25 mm
0,65 €/Stk./pcs.

Best.-Nr. **9215**
Lochung ø 14,5 mm, ø 35 x 25 mm
0,65 €/Stk./pcs.

Best.-Nr.
9210
ø 40 x 90 mm
2,15 €/Stk./pcs.

Best.-Nr. **9206**
ø 37 mm
0,15 €/Stk./pcs.

Best.-Nr. **9207**
ø 45 mm
0,50 €/Stk./pcs.

Best.-Nr. **9208**
ø 55 mm
0,80 €/Stk./pcs.

Best.-Nr. **9209**
ø 65 mm
1,40 €/Stk./pcs.

≥ 2,15
€/Stk./pcs.

Best.-Nr. **9212**
Lochung ø 12,5 mm, ø 40 x 68 mm
1,39 €/Stk./pcs.

Best.-Nr. **9213**
Lochung ø 14,5 mm, ø 40 x 68 mm
1,39 €/Stk./pcs.

Best.-Nr. **9211**
Lochung 12,5 x 12,5 mm
40 x 40 x 70 mm
1,89 €/Stk./pcs.

øD /mm	Gewicht /kg	Best.-Nr.	€/Stk./ pcs.
37	0,15	9206	2,15
45	0,50	9207	2,69
55	0,80	9208	4,95
65	1,40	9209	7,55

AK FER

Ringe / Anneau / Ring

Verschweisst und sauber verschliffen / Soudé et lissé / Welded



≥ 0,77
€/Stk./pcs.

Material ● 12 mm

øD /mm	Best.-Nr.	€/Stk./ pcs.
100	6600	0,87
110	6601	0,93
120	6602	0,99

Material ■ 12 x 12 mm

100	6610	0,99
110	6611	1,05
120	6612	1,10

Material 12 x 6 mm

100	6620	0,77
110	6621	0,82
120	6622	0,87

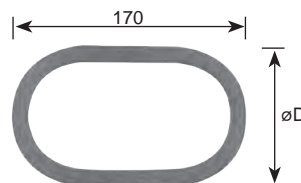

≥ 1,05
€/Stk./pcs.

Material ● 12 mm

øD /mm	Best.-Nr.	€/Stk./ pcs.
100	6650	1,16
110	6651	1,21
120	6652	1,26

Material ■ 12 x 12 mm

100	6660	1,32
110	6661	1,37
120	6662	1,43

Material 12 x 6 mm

100	6670	1,05
110	6671	1,10
120	6672	1,16

AK FER

Ornamente / Ornaments / Ornaments

Material: 12 x 6 mm

Profiqualität!



Best.-Nr. 6017
240 x 240 mm

6,59 €/Stk./pcs.

Best.-Nr. 6018
300 x 300 mm

8,19 €/Stk./pcs.

Material: 12 x 6 mm

Profiqualität!



Best.-Nr. 6053
240 x 240 mm

8,69 €/Stk./pcs.

Best.-Nr. 6054
300 x 300 mm

10,39 €/Stk./pcs.

Material: 12 x 6 mm



Best.-Nr. 6042
150 x 270 mm

2,89 €/Stk./pcs.



Best.-Nr. 6043
120 x 210 mm

2,09 €/Stk./pcs.



Best.-Nr. 6044
120 x 210 mm

2,39 €/Stk./pcs.



Best.-Nr. 6045
100 x 120 mm

0,85 €/Stk./pcs.



Best.-Nr. 6049
Zwirbel 20

3,55 €/Stk./pcs.



Best.-Nr. 6048
Zwirbel 12

0,95 €/Stk./pcs.

Ornament 650 x 450 mm

42,95

€/Stk./pcs.

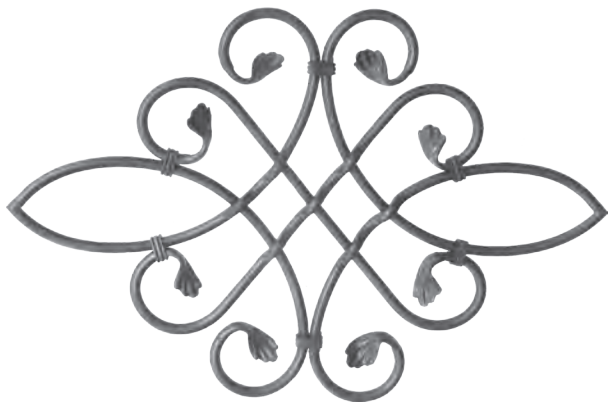

Best.-Nr. 9400 aus \varnothing 12 mm, 3,50 kg

glatt

lisse / plain

Best.-Nr. 9401 aus 16 x 8 mm, 3,75 kg

gehämmert

martelé / hammered

Best.-Nr. 9402 aus 16 x 8 mm, 3,75 kg

gerillt /

rainure sur la tranche / grooved

Ornament 500 x 450 mm

42,95

€/Stk./pcs.



Best.-Nr. 9410 aus \varnothing 12 mm, 3,25 kg

glatt

lisse / plain /

Best.-Nr. 9411 aus 16 x 8 mm, 3,50 kg

gehämmert

martelé / hammered

Best.-Nr. 9412 aus 16 x 8 mm, 3,50 kg

gerillt

rainure sur la tranche / grooved

Ornament 615 x 775 mm

61,95

€/Stk./pcs.

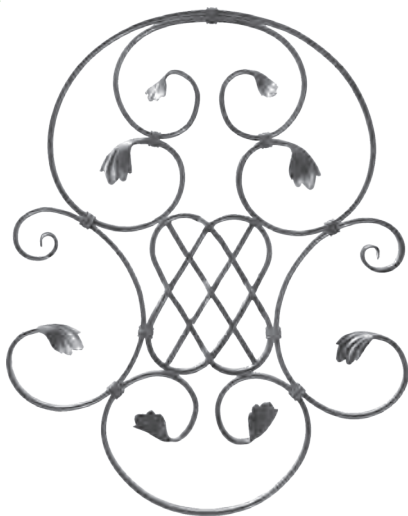

Best.-Nr. 9406 aus \varnothing 12 mm, 6,20 kg

glatt

lisse / plain

Best.-Nr. 9407 aus 16 x 8 mm, 6,87 kg

gehämmert /

martelé / hammered

Best.-Nr. 9408 aus 16 x 8 mm, 6,87 kg

gerillt /

rainure sur la tranche / grooved

Ornament 710 x 710 mm

48,95

€/Stk./pcs.

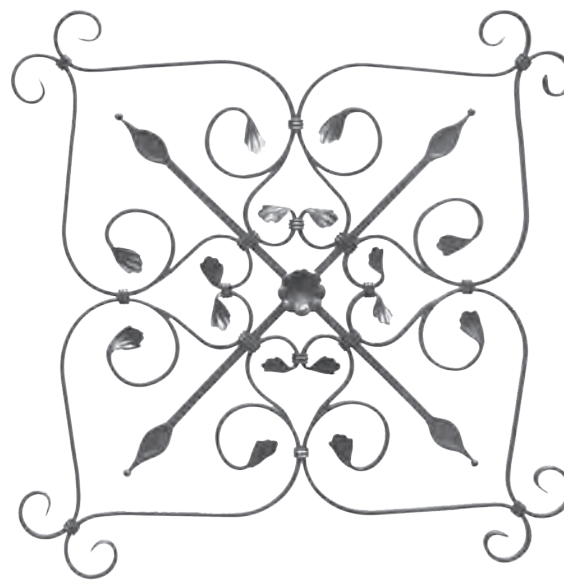

Best.-Nr. 9403 aus 12 x 6 mm, 5,88 kg

glatt

lisse / plain

AK FER

Zierblätter / Feuilles / Leaves



Best.-Nr. **12007**
155 x 60 mm
Material 3 mm

1,59 €/Stk./pcs.



Best.-Nr. **12008**
155 x 60 mm
Material 3 mm

1,59 €/Stk./pcs.



Best.-Nr. **12035**
Rosenblatt
32 x 47 mm
Material 1 mm

0,42 €/Stk./pcs.



Best.-Nr. **12009**
95 x 115 mm
Material 3 mm

1,59 €/Stk./pcs.



Best.-Nr. **12010**
95 x 115 mm
Material 3 mm

1,59 €/Stk./pcs.



Best.-Nr. **12003**
80 x 85 mm
Material 3 mm

0,85 €/Stk./pcs.



Best.-Nr. **12004**
80 x 85 mm
Material 3 mm

0,85 €/Stk./pcs.



Best.-Nr. **12005**
110 x 40 mm
Material 3 mm

0,55 €/Stk./pcs.



Best.-Nr. **12006**
110 x 40 mm
Material 3 mm

0,55 €/Stk./pcs.

Best.-Nr. **12036**
Länge ca.
340 mm

10,79 €/Stk./pcs.

Best.-Nr. **12037**
Länge ca.
200 mm

7,59 €/Stk./pcs.



Best.-Nr. **12029**
125 x 85 mm
Material 3 mm

1,89 €/Stk./pcs.



Best.-Nr. **12031**
200 x 95 mm
Material 6 mm

8,29 €/Stk./pcs.



Best.-Nr. **12032**
205 x 100 mm
Material 3 mm

2,79 €/Stk./pcs.



Best.-Nr. **12033**
160 x 60 mm
Material 3 mm

4,39 €/Stk./pcs.



Best.-Nr. **12013**
60 x 70 mm
Material 3 mm

0,55 €/Stk./pcs.



Best.-Nr. **12012**
60 x 70 mm
Material 3 mm

0,55 €/Stk./pcs.



Best.-Nr. **12038**
75 x 85 mm
Material 3 mm

1,69 €/Stk./pcs.



Best.-Nr. **12017**
200 x 140 mm
Material 6 mm

9,39 €/Stk./pcs.



Best.-Nr. **12018**
200 x 140 mm
Material 6 mm

9,39 €/Stk./pcs.



Best.-Nr. **12019**
200 x 130 mm
Material 6 mm

9,89 €/Stk./pcs.



Best.-Nr. **12020**
200 x 130 mm
Material 6 mm

9,89 €/Stk./pcs.



Best.-Nr. **12039**
Weintraube
ca. 85 x 65 mm

13,99 €/Stk./pcs.



Best.-Nr. **12040**
Weintraube
ca. 55 x 65 mm

9,69 €/Stk./pcs.



Best.-Nr. **12030**
310 x 260 mm
Material 6 mm

21,99 €/Stk./pcs.



Best.-Nr. **12027**
200 x 135 mm
Material 3 mm

8,29 €/Stk./pcs.

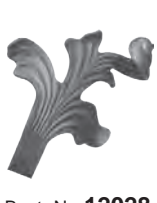

Best.-Nr. **12028**
200 x 135 mm
Material 3 mm

8,29 €/Stk./pcs.



Best.-Nr. **12024**
110 x 80 mm
Material 3 mm

1,05 €/Stk./pcs.



Best.-Nr. **12025**
110 x 80 mm
Material 3 mm

1,05 €/Stk./pcs.



Best.-Nr. **12014**
415 x 185 mm
Material 6 mm

13,79 €/Stk./pcs.



Best.-Nr. **12015**
415 x 185 mm
Material 6 mm

13,79 €/Stk./pcs.



Best.-Nr. **12041**
ca. 165 x 110 mm

8,99 €/Stk./pcs.



Best.-Nr. **12034**
Pfosten-Krone
90 x 170 mm

13,79 €/Stk./pcs.



Best.-Nr. **12022**
210 x 135 mm
Material 6 mm

9,89 €/Stk./pcs.



Best.-Nr. **12023**
210 x 135 mm
Material 6 mm

9,89 €/Stk./pcs.

AK FER

AK FER

**Schmiedeeisen-Drückergarnituren
Poignées en fer forgé / Wrought iron handles**

Oberfläche: galvanisch verzinkt, lackiert, gebürstet, transparent pulverbeschichtet

Surface : galvanisé, laqué, brossé, revêtement par poudre / Surface: zinc plated, lacquered, brushed, powder coated

Beispiele möglicher Kombinationen
Exemples de combinaisons possibles
Possible combination examples

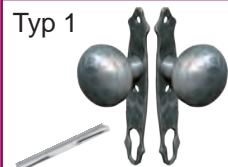

25,95
€/Satz/Set



25,95
€/Satz/Set



25,95
€/Satz/Set



23,95
€/Satz/Set



23,95
€/Satz/Set



19,95
€/Satz/Set



13,95
€/Stk./pcs.

Best.-Nr.
10625-F
Knopf
fest/ fix
Best.-Nr.
10625-D
Knopf
drehbar/ non-fix



3,75
€/Stk./pcs.

72
30 x 160 mm
Best.-Nr.
10622
passend auf Kastenschloss

123
4567
890
abcd

Best.-Nr./Code
10632

3,19 €/Stk./pcs.



Best.-Nr.
10621-R
8,95
€/Stk./pcs.

Best.-Nr.
10621-L



8,95
€/Stk./pcs.

Best.-Nr.
10623-R
Best.-Nr.
10623-L

Best.-Nr.
10624
Knopf
fest/ fix
8,95
€/Stk./pcs.

Best.-Nr.
10628
Knopf
drehbar/ non-fix
1,75
€/Stk./pcs.

Ø 50 mm
Best.-Nr.
10629-FU
1,75
€/Stk./pcs.

Ø 50 mm
Best.-Nr.
10629-PZ
1,75
€/Stk./pcs.



Seite / Page / Page 120

AK FER

**Schmiedeeisen-Schlossblenden
Plaques de serrure en fer forgé / Wrought iron lock plates**

E = 72 mm, A = 60 mm

E = 72 mm, A = 40 mm

E = 72 mm, A = 60 mm

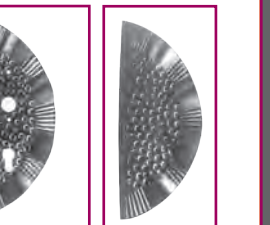
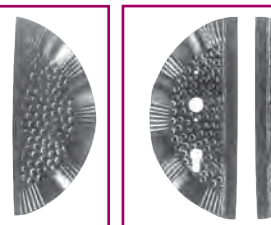
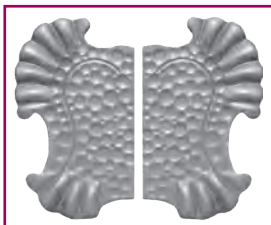
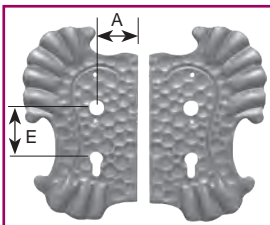

Best.-Nr. 10407 275x160 mm 0,72 kg 7,19 €/Stk./pcs.	Best.-Nr. 10408 275x160 mm 0,72 kg 7,19 €/Stk./pcs.	Best.-Nr. 10409 275x160 mm 0,75 kg 6,89 €/Stk./pcs.	Best.-Nr. 10410 275x160 mm 0,75 kg 6,89 €/Stk./pcs.	Best.-Nr. 10401 120x290 mm 0,61 kg 6,69 €/Stk./pcs.	Best.-Nr. 10402 120x290 mm 0,61 kg 6,69 €/Stk./pcs.	Best.-Nr. 10403 120x290 mm 0,64 kg 6,29 €/Stk./pcs.	Best.-Nr. 10404 130x290 mm 0,67 kg 6,89 €/Stk./pcs.	Best.-Nr. 10405 130x290 mm 0,67 kg 6,89 €/Stk./pcs.	Best.-Nr. 10406 130x290 mm 0,70 kg 6,69 €/Stk./pcs.
--	--	--	--	--	--	--	--	--	--

E-mail: info@akbas-schmiedeeisen.de, www.akbas-schmiedeeisen.de

Tel: +49(0) 61 44 33 05-0, Fax: +49(0) 61 44 33 05-15

Tel: +33.3.68680131, E-mail: vente@akbas-schmiedeeisen.de, Tel: +44.151.6018946, E-mail: sales@akbas-schmiedeeisen.de

AK FER

Torbänder / Gonds / Door hinges

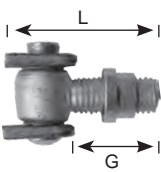

≥ 2,69 €/Stk./pcs.

Für/for/pour	L x G	Best.-Nr.	€/Stk./pcs.
M18	75 x 40	10513	2,69
M22	85 x 46	10514	3,19

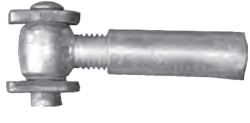

≥ 3,09 €/Stk./pcs.

Für/for/pour	Best.-Nr.	€/Stk./pcs.
M18	10519	3,09
M22	10520	4,29

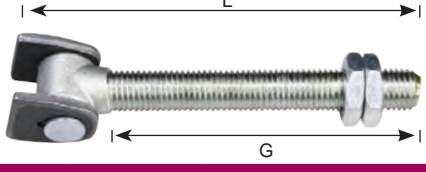

≥ 3,79 €/Stk./pcs.

Für/for/pour	L x G	Best.-Nr.	€/Stk./pcs.
M12	175 x 142	10517-12	3,79
M16	175 x 142	10517-16	3,99
M20	175 x 142	10517-20	4,29
M24	186 x 155	10518	5,39

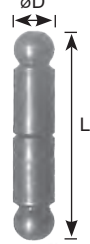

≥ 2,19 €/Stk./pcs.

øD /mm	L /mm	Best.-Nr.	€/Stk./pcs.
30	150	10501	4,69
24	120	10502	3,29
20	100	10503	2,19



≥ 2,39 €/Stk./pcs.

øD /mm	L /mm	Best.-Nr.	€/Stk./pcs.
30	150	10505	4,89
24	120	10506	3,59
20	100	10507	2,39

Nouveau - New



≥ 4,29 €/Stk./pcs.

Für/for/pour	H x B	Best.-Nr.	€/Stk./pcs.
M12	40 x 75	10517-12-L	4,29
M16	40 x 75	10517-16-L	4,49
M20	55 x 100	10517-20-L	4,89
M24	55 x 100	10517-24-L	5,99



≥ 13,19 €/Stk./pcs.

3-teilig mit Anschweißhülse
Auf Wunsch mit Mauerhülse erhältlich!

øD /mm	Kegel ø/mm	Für/for/pour	Best.-Nr.	€/Stk./pcs.
24	14	M20	10508	13,19
30	20	M22	10509	15,89



≥ 12,09 €/Stk./pcs.

øD /mm	Kegel ø/mm	Für/for/pour	Best.-Nr.	€/Stk./pcs.
24	14	M20	10511	12,09
30	20	M22	10512	13,19



≥ 6,69 €/Stk./pcs.

øD /mm	L /mm	Best.-Nr.	€/Stk./pcs.
30	150	10510	6,69



≥ 3,79 €/Stk./pcs.

M	øD /mm	H /mm	A /mm	B /mm	Best.-Nr.	€/Stk./pcs.
M16	53	79	30	43	10521-16	3,79
M20	66	85	30	43	10521-20	4,49
M24	65	101	35	49	10521-24	6,29



≥ 5,59 €/Stk./pcs.

M	H /mm	B /mm	L /mm	C /mm	Best.-Nr.	€/Stk./pcs.
M16	62-83	43	79	79	10523-16	5,59
M20	62-90	43	100	100	10523-20	6,89
M24	68-100	49	120	120	10523-24	9,39



≥ 2,99 €/Stk./pcs.

M	H /mm	B /mm	A /mm	Best.-Nr.	€/Stk./pcs.
M12	79	35	26	10522-12	2,99
M16	79	42	30	10522-16	3,49
M20	86	42	30	10522-20	3,99
M24	101	46	35	10522-24	5,89

Stahl St. 37 / Steel

AK FER

Torbänder / Gonds / Door hinges

Halseinband mit Einschweißmutter, verzinkt
 Couverture de cou avec écrou soudé, zingué
 Neck cover with weld nut, zinc plated

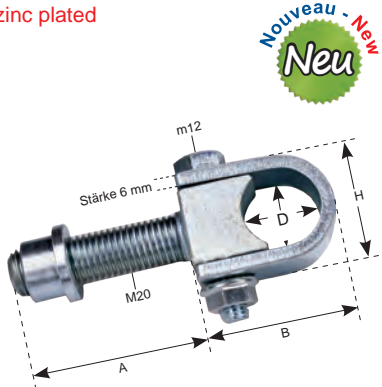

M	øD /mm	H /mm	A /mm	B /mm	Best.-Nr.	€/Stk. /pcs.
M20	30	42	65	58	10524-20	4,99

Halseinband mit Hülse und Wandanschlussplatte
 Couverture de cou avec manche et plaque de raccordement mural
 Neck cover with sleeve and wall connection plate

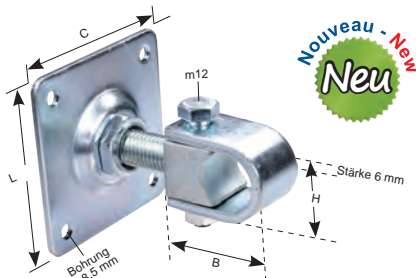

M	H /mm	B /mm	L /mm	C /mm	Best.-Nr.	€/Stk. /pcs.
M20	42	58	100	100	10525-20	7,89

Halseinband mit Hülse und Rundeplatte feuerverzinkt - verstellbar
 Couverture de cou avec manche et plaque ronde, galvanisé, réglable
 Neck cover with sleeve and round plate, galvanized, adjustable



M	L /mm	B /mm	P /mm	Best.-Nr.	€/Stk. /pcs.
M20	130	42	60	10526-20	6,69
M24	150	47	65	10526-24	7,69

Oberfläche Feuerverzinkt
 Surface galvanisé
 Surface zinc plated



A /mm	Best.-Nr.	€/Stk./pcs. ≤ 4	€/Stk./pcs. ≥ 5
33	10701	8,99	8,49
43	10702	8,99	8,49
ohne Loch	10705	8,99	8,49

Torfuß flach, verzinkt, Material 2 mm

2 Varianten

SWS01 klein
 SWS02 groß

≥ 4,49 €/Stk./pcs.



Gewicht / kg	B x L x H / mm	Bohrung	Best.-Nr.	€/ Stk / pcs.
0,220	100 x 120 x 50	ø 8,5 mm	10703	4,49
0,370	138 x 158 x 50	ø 8,5 mm	10704	6,49

Torriegel, gelb verzinkt, mit Schlaufe
 Loquet de porte, zingué jaune, avec boucle
 Door latch, yellow zinc plated, with loop



Platte / mm	Griffhöhe / Riegelhöhe / Riegelende / mm	Best.-Nr.	€/ Stk / pcs.
45 x 150	25 / 130 / 36	10703-150	5,49
45 x 190	25 / 130 / 36	10703-190	7,49

Winkelband, 2-teilig Kurzform, schwarz, mit Kugellager
 Bande d'angle, 2 pièce courte, noir avec palier.
 Angle band, 2-piece short, black with bearing

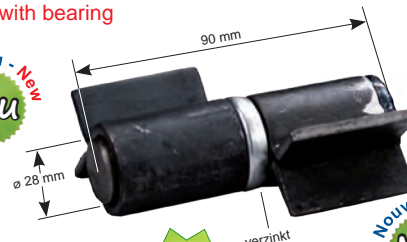

Maße / mm	Best.-Nr.	€/ Stk / pcs.
28 x 90	10527-20	2,49

Konstruktionsband Oberfläche Stahl, blank, loser, verzinkter Stift mit Kugellager
 bande de construction Surface d'acier, blanc, lâche, broches galvanisé avec palier.
 construction tape Steel surface, blank, loose, galvanized pin with bearing



Maße / mm	Best.-Nr.	€/ Stk / pcs.
120	10528-120	2,49
140	10528-140	2,99

Freitragendes Schiebetor-System
Système porte coulissante
Cantilever sliding gate system

3
Varianten

Klein bis 350 kg
Mittel bis 600 kg
Groß bis 1200 kg

Nouveau - New
Neu



289,00
€/Satz/Set

Klein bis 350 kg

Bestehend aus	Best.-Nr.		€/Stk/pcs	€/Gesamt
6 m Laufschiene unverzinkt	10728-S	für 3 m Laufschiene	59,00	118,00
2 x Rollenböcke	10732-S od.10733-S	für 1 Rollenbock	79,00	158,00
1 x Auflaufschuh	10722-65			7,49
1x Frontabdeckung mit Führungsrolle	10731-S			14,95
1 x Hintere Abdeckung	10730-S			6,95
1 x Stopper	10729			7,49
2 x Führungsrolle	10720-2540W	für 1 Führungsrolle	1,89	3,78
				statt 316,66
Komplettes Set			10734-S	289,00 €

Mittel bis 600 kg

Bestehend aus	Best.-Nr.		€/Stk/pcs	€/Gesamt
6 m Laufschiene unverzinkt	10728-M	für 3 m Laufschiene	79,00	158,00
2 x Rollenböcke	10732-M od.10733-M	für 1 Rollenbock	109,00	218,00
1 x Auflaufschuh	10722-85			8,79
1x Frontabdeckung mit Führungsrolle	10731-M			18,95
1 x Hintere Abdeckung	10730-M			8,95
1 x Stopper	10729			7,49
2 x Führungsrolle 10720-3140	10720-3140W	für 1 Führungsrolle	2,39	4,78
				statt 424,96
Komplettes Set			10734-M	399,00 €

Groß bis 1200 kg

Bestehend aus	Best.-Nr.		€/Stk/pcs	€/Gesamt
6 m Laufschiene unverzinkt	10728-L	für 3 m Laufschiene	119,00	238,00
2 x Rollenböcke	10732-L od.10733-L	für 1 Rollenbock	379,00	758,00
1 x Auflaufschuh	10722-100			14,99
1x Frontabdeckung mit Führungsrolle	10731-L			25,95
1 x Hintere Abdeckung	10730-L			14,95
1 x Stopper	10729			7,49
2 x Führungsrolle	10720-4140W	für 1 Führungsrolle	2,99	5,98
				statt 1065,36
Komplettes Set			10734-L	999,00 €

AK FER

Schiebetor-System / Système porte / Sliding gate system

Hintere Abdeckung
capot arrière
Rear cover



≥ 6,95
€/Stk./pcs.

Nouveau - New
Neu

A	Best.-Nr.	€/ Stk / pcs.
70	10730-S	6,95
100	10730-M	8,95
140	10730-L	14,95

Frontabdeckung mit Führungsrolle
Rouler couverture avec un guide
Front cover with leadership

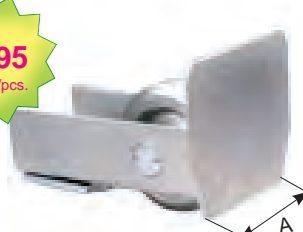

≥ 14,95
€/Stk./pcs.

Nouveau - New
Neu

A	Best.-Nr.	€/ Stk / pcs.
70	10731-S	14,95
100	10731-M	18,95
140	10731-L	25,95

Nylon-Führungsrolle
Cylindre-guidant en nylon Nylon
roller



≥ 1,89
€/Stk./pcs.

øD x H /mm	M	Best.-Nr.	€/Stk. /pcs.
25 x 40	12	10720-2540W	1,89
31 x 40	12	10720-3140W	2,39
41 x 43	16	10720-4140W	2,99
41 x 43	16	10720-4140B	2,99

Rollenbock
Système d'accrochage sur rail
pour portail coulissant

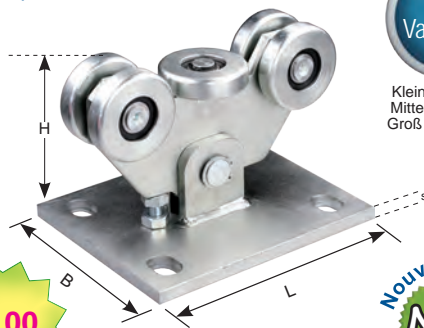

3
Varianten

Klein bis 350 kg
Mittel bis 600 kg
Groß bis 1200 kg

≥ 79,00
€/Stk./pcs.

Nouveau - New
Neu

LxB / mm	H / mm	s / mm	Best.-Nr.	€/ Stk / pcs.
180x150	120	9,5	10732-S	79,00
300x150	160	9,5	10732-M	109,00
500x200	200	9,5	10732-L	379,00

Laufschiene unverzinkt, 3 m
Rail de roulement ungalvanisé
Running rail ungalvanised



≥ 59,00
€/Stk./pcs.

Nouveau - New
Neu

BxH / mm	Best.-Nr.	€/ Stk / pcs.
70x70	10728-S	59,00
100x100	10728-M	79,00
140x140	10728-L	119,00



≥ 7,49
€/Stk./pcs.

Ax Bx H /mm	Best.-Nr.	€/Stk. /pcs.
100 x 100 x 140	10729	7,49

Rollenbock,
Système d'accrochage sur rail
pour portail coulissant



3
Varianten

Klein bis 350 kg
Mittel bis 600 kg
Groß bis 1200 kg

≥ 79,00
€/Stk./pcs.

Nouveau - New
Neu

LxB / mm	H / mm	s / mm	Best.-Nr.	€/ Stk / pcs.
180x150	120	9,5	10733-S	79,00
300x150	160	9,5	10733-M	109,00
500x200	200	9,5	10733-L	379,00

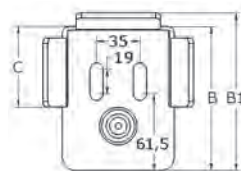
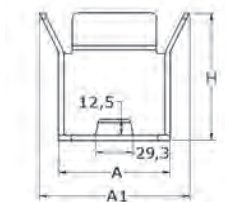

≥ 7,49
€/Stk./pcs.

H /mm	A /mm	A1 /mm	B /mm	B1 /mm	Best.-Nr.	€/Stk. /pcs.
80	125	100	65	140	10722-65	7,49
80	125	115	85	140	10722-85	8,79
105	165	125	100	180	10722-100	14,99

E-mail: info@akbas-schmiedeeisen.de, www.akbas-schmiedeeisen.de

Tel: +49(0) 61 44 33 05-0, Fax: +49(0) 61 44 33 05-15

Tel: +33.3.68680131, E-mail: vente@akbas-schmiedeeisen.de, Tel: +44.151.6018946, E-mail: sales@akbas-schmiedeeisen.de

AK FER

Torführungsbügel / Platines guides-portails / Drive-gate plates



Nouveau - New
Neu

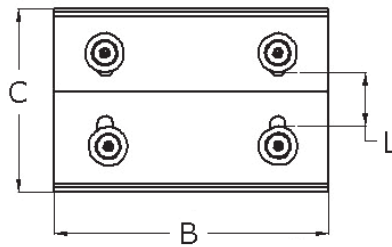

≥ **18,99**
€/Stk./pcs.

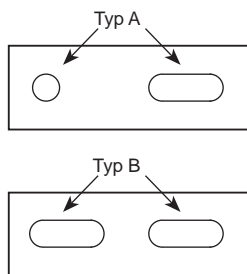
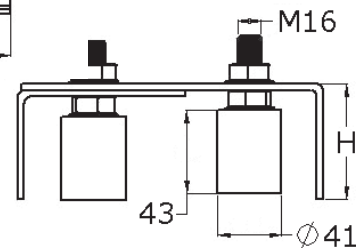

Best.-Nr.	Typ A	Typ B	B /mm	C /mm	L /mm	H /mm	Roller /mm	€/Stk. /pcs.
10724-220-1	X		220	150-210	20-65	55	Ø41 x 43	18,99
10724-220-1		X	220	135-180	30-75	55	Ø41 x 43	18,99
10724-220-2	X		220	115-180	15-65	55	Ø31 x 43	18,99
10724-220-2		X	220	135-180	30-75	55	Ø31 x 43	18,99
10725-290	X		290	170-260	55-100	65	Ø41 x 43	34,99
10725-290		X	290	170-260	20-100	65	Ø41 x 43	34,99
10725-350	X		350	170-260	55-100	65	Ø41 x 43	37,99
10725-350		X	350	170-260	20-100	65	Ø41 x 43	37,99



Nouveau - New
Neu

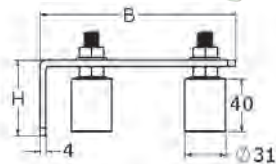

≥ **4,39**
€/Stk./pcs.

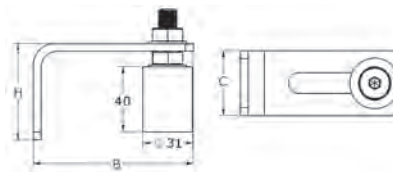

Best.-Nr.	B /mm	L /mm	H /mm	C /mm	Roller /mm	€/Stk. /pcs.
10727-25	150	20-65	55	40	Ø25 x 40	5,99
10727-31	150	11-60	55	40	Ø31 x 40	6,29

Best.-Nr.	B /mm	H /mm	C /mm	Roller /mm	€/Stk. /pcs.
10726-25	100	60	40	Ø25 x 40	4,39
10726-31	100	60	40	Ø31 x 40	4,69



7,49
€/Stk./pcs.

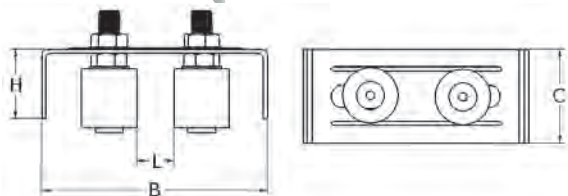

Best.-Nr.	B /mm	L /mm	H /mm	Roller /mm	€/Stk. /pcs.
10723-70	165	30-70	65	Ø41 x 43	7,49



8,79
€/Stk./pcs.

Nouveau - New
Neu

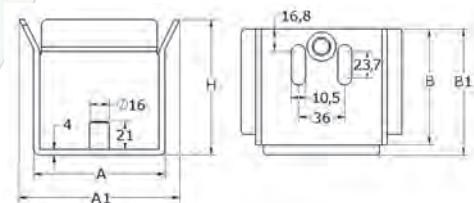

H /mm	A /mm	A1 /mm	B /mm	B1 /mm	Best.-Nr.	€/Stk. /pcs.
98,5	102	137	98	118	10721-100	8,79

Stahl St. 37 / Steel

AK FER

Schiebtorrollen / Galets / Wheels



Y - Rille / Gorge Y / Y-Groove						
øD /mm	H /mm	øD1 /mm	A /mm	M /mm	Best.-Nr.	€/Stk. /pcs.
58	17	44,6	13,6	10	10712-60Y	3,39
68	20	51,6	16,0	10	10712-70Y	4,29
78	20	61,6	16,5	10	10712-80Y	4,99

U - Rille / Gorge U / U-Groove						
øD /mm	H /mm	øD1 /mm	A /mm	M /mm	Best.-Nr.	€/Stk. /pcs.
58	17	49	13,6	10	10712-60U	3,39
68	20	57	16,0	10	10712-70U	4,29
78	20	68	16,5	10	10712-80U	4,99
100	20	90	16,5	12	10712-100U	7,99
120	20	110	16,5	12	10712-120U	9,49

Schiebtorrolle mit 2 Kugellägern
Galet à 2 roulements
Wheel with 2 bearings

V - Rille / Gorge V / V-Groove						
øD /mm	øD1 /mm	H /mm	A /mm	Best.-Nr.	€/Stk. /pcs.	
58	43,00	31	15	10709-60V	4,79	
68	51,70	31	16	10709-70V	5,99	
78	61,00	30	17	10709-80V	6,89	

Schiebtorrolle mit 2 Kugellägern
Galet à 2 roulements
Wheel with 2 bearings

V - Rille / Gorge V / V-Groove							
øD /mm	øD1 /mm	H /mm	A /mm	B /mm	C /mm	Best.-Nr.	€/Stk. /pcs.
58	44,6	65	16	44,0	48	10708-60V	5,69
68	51,6	79	16	44,5	80	10708-70V	7,19
78	61,6	84	16	44,5	80	10708-80V	7,99

Y - Rille / Gorge Y / Y-Groove								
øD /mm	øD1 /mm	A /mm	B /mm	C /mm	E /mm	L /mm	Best.-Nr.	€/Stk. /pcs.
78	61,6	15,5	32	136	20	112,0	10711-80Y	5,69
88	70,4	16,0	32	152	21	128,5	10711-90Y	7,49
98	79,5	16,5	32	152	22	128,5	10711-100Y	8,79

U - Rille / Gorge U / U-Groove								
øD /mm	øD1 /mm	A /mm	B /mm	C /mm	E /mm	L /mm	Best.-Nr.	€/Stk. /pcs.
78	68,0	15,5	32	136	20	112,0	10711-80U	5,69
88	77,0	16,0	32	152	21	128,5	10711-90U	7,49
98	86,4	16,5	32	152	22	128,5	10711-100U	8,79

Y - Rille / Gorge Y / Y-Groove						
øD /mm	øD1 /mm	A /mm	B /mm	L /mm	Best.-Nr.	€/Stk. /pcs.
58	44,6	14,0	39	59	10713-60Y	3,79
68	51,6	16,5	39	59	10713-70Y	4,39
78	61,6	15,5	41	71	10713-80Y	4,99

U - Rille / Gorge U / U-Groove						
øD /mm	øD1 /mm	A /mm	B /mm	L /mm	Best.-Nr.	€/Stk. /pcs.
58	49	14,0	39	59	10713-60U	2,99
68	57	16,5	39	59	10713-70U	3,49
78	68	15,5	41	71	10713-80U	3,99

Y - Rille / Gorge Y / Y-Groove								
øD /mm	øD1 /mm	H /mm	A /mm	B /mm	C /mm	L /mm	Best.-Nr.	€/Stk. /pcs.
58	44,6	63,80	13,3	27,65	85	55	10710-60Y	4,39
68	51,6	79,00	15,3	34,25	100	70	10710-70Y	5,39
78	61,6	84,65	15,6	34,40	100	70	10710-80Y	6,19
98	79,5	106,00	16,5	36,00	132	105	10710-100Y	8,79

U - Rille / Gorge U / U-Groove								
øD /mm	øD1 /mm	H /mm	A /mm	B /mm	C /mm	L /mm	Best.-Nr.	€/Stk. /pcs.
58	49,0	63,80	13,3	27,65	85	55	10710-60U	4,39
68	57,0	79,00	15,3	34,25	100	70	10710-70U	5,39
78	68,0	84,65	15,6	34,40	100	70	10710-80U	6,19
98	86,4	106,00	16,5	36,00	132	105	10710-100U	8,79

E-mail: info@akbas-schmiedeeisen.de, www.akbas-schmiedeeisen.de

Tel: +49(0) 61 44 33 05-0, Fax: +49(0) 61 44 33 05-15

Tel: +33.3.68680131, E-mail: vente@akbas-schmiedeeisen.de, Tel: +44.151.6018946, E-mail: sales@akbas-schmiedeeisen.de

AK FER

Schiebetor-System / Système porte / Sliding gate system

Bodenlaufschiene zum Aufschrauben, verzinkt 3 m
 Monté au sol rail pour fixation galvanisé,
 Floor mounted rail for bolting galvanized
 Auslieferung ohne Befestigungsschrauben

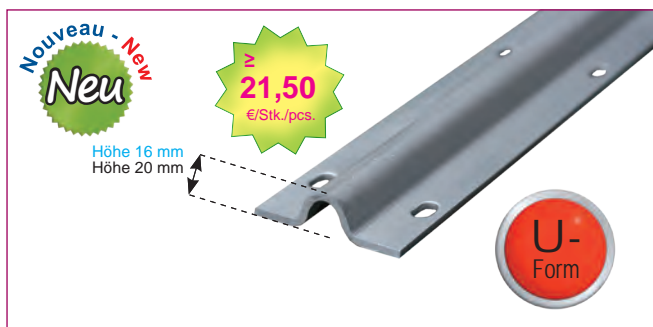

Breite x Höhe / mm	Stärke / mm	Best.-Nr.	€/ 3 m
55 x 16	4	10714-16-U	21,50
55 x 20	4	10714-20-U	24,50

Wandhalter für Hängetore / Laufschiene, verzinkt, verstellbar
 Support mural pour accrocher portes
 Wall bracket for hanging doors

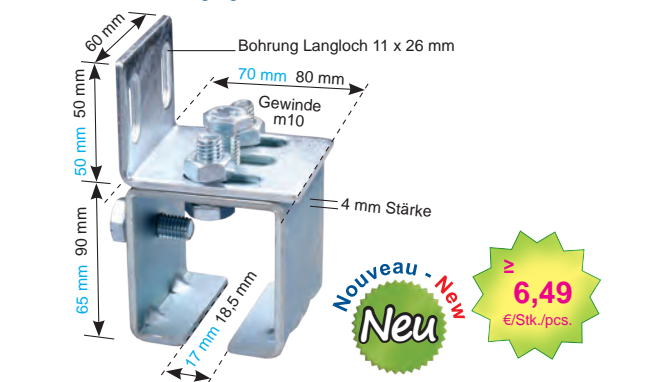

Höhe / mm	Best.-Nr.	€/ Stk / pcs.
115	10742-S	6,49
140	10742-M	7,49

Bodenlaufschiene zum Aufschrauben, verzinkt 3 m
 Monté au sol rail pour fixation galvanisé,
 Floor mounted rail for bolting galvanized
 Auslieferung ohne Befestigungsschrauben

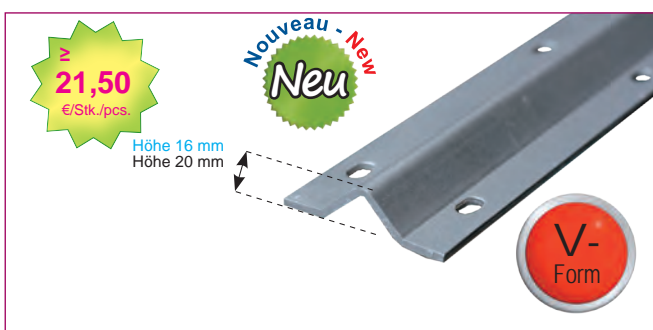

Breite x Höhe / mm	Stärke / mm	Best.-Nr.	€/ 3 m
55 x 16	4	10715-16-V	21,50
55 x 20	4	10715-20-V	24,50

Rollapparat, verzinkt mit Kugellager, für Hängetore, zweifach
 Reeler, galvanisé avec roulement à billes pour les portes,
 deux fois suspendu

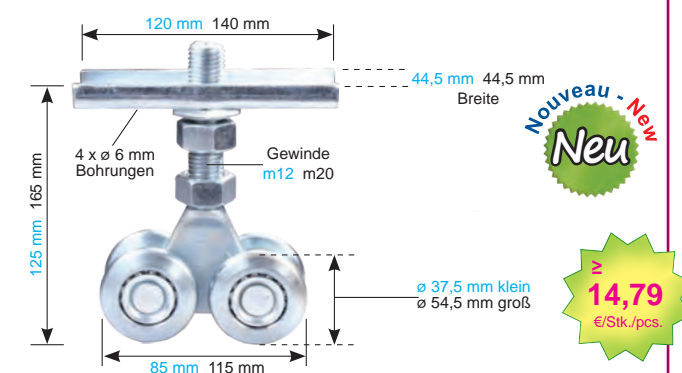

ø / mm	Gewinde	Best.-Nr.	€/ Stk / pcs.
37,5	m12	10740-12	14,79
54,5	m20	10740-20	18,79

Laufschiene verzinkt für Hängetore, 3 m
 Rail supérieur galvanisé
 Galvanized top track



Breite x Höhe / mm	Best.-Nr.	€/ 3 m
50 x 50	10743-50	39,50
60 x 70	10743-60	59,50

Wandhalter für Hängetore / Laufschiene, verzinkt, verstellbar

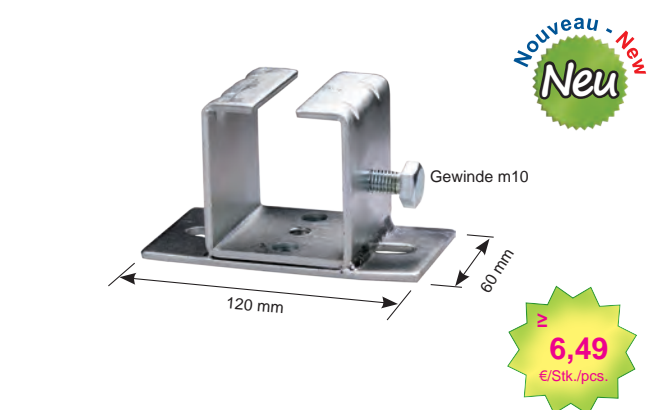

Höhe	Best.-Nr.	€/ Stk / pcs.
65	10741-S	6,49
90	10741-M	7,49

Torlagerung, verzinkt mit Kegel-Rollenlager
 Stockage de porte ci-dessus, les roulements à rouleaux coniques galvanisé
 Gate storage above, galvanized cone-roller bearings

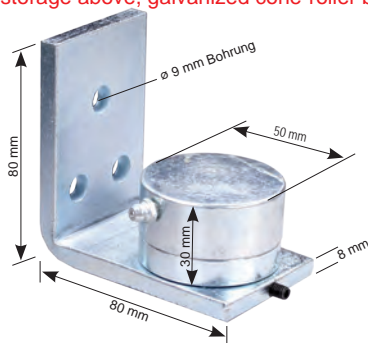

Nouveau - New
Neu

17,95
 €/Stk./pcs.

Gewicht / kg	ø / Höhe / mm	Maße / mm Anschweißlasche	Best.-Nr.	€ / Stk / pcs.
0,895	50 x 30	80 x 80 x 8	10744	17,95

Torlagerung, verzinkt mit Kugellager

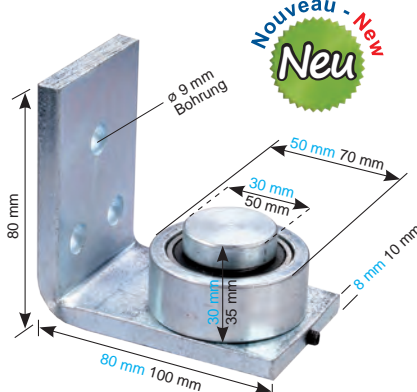

Nouveau - New
Neu

≥ 17,95
 €/Stk./pcs.

Gewicht / kg	ø / H ohne Platte / mm	Platte B x L / mm	Best.-Nr.	€ / Stk / pcs.
0,786	50 x 30	80 x 80 x 8	10745-50	17,95
1,490	70 x 35	80 x 100 x 10	10745-70	21,49

Torlagerung, verzinkt mit Kugellager
 Stockage de Porte-dessus, galvanisé avec roulements à billes
 Gate storage above, galvanized with ball bearings



Nouveau - New
Neu

≥ 12,95
 €/Stk./pcs.

Gewicht / kg	ø / Höhe / mm	Maße / mm Anschweißlasche	Best.-Nr.	€ / Stk / pcs.
0,408	38 x 30	90 x 40 x 8	10746-38	12,95
0,624	50 x 28,5	100 x 50 x 8	10746-50	15,95

Führungsbügel mit Nylonrolle verzinkt, verstellbar
 Support de guidage avec le rouleau de nylon, galvanisé, réglable
 Guide bracket with nylon roller, galvanized, adjustable

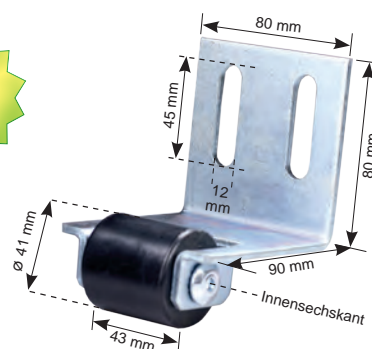

4,99
 €/Stk./pcs.

Nouveau - New
Neu

Gewicht / kg	Rolle Breite / ø / mm	Platte B x L / mm	Best.-Nr.	€ / Stk / pcs.
0,486	43 / 41	80 x 80	10749	4,99

Untere Drehplatte / Torlagerung unten
 zum Anschweißen mit Kugellager
 Plaque inférieure tournant, le stockage de porte ci-dessous, pour souder avec roulement à billes
 Lower rotating plate, door storage below, for welding with ball bearing



Nouveau - New
Neu

14,95
 €/Stk./pcs.

Gewicht / kg	ø / Höhe / mm	Best.-Nr.	€ / Stk / pcs.
0,246	40 x 30	10747	14,95

Untere Drehplatte / Torlagerung unten
 zum Anschweißen mit Kegel Rollenlager



Nouveau - New
Neu

≥ 14,95
 €/Stk./pcs.

Gewicht / kg	ø / Höhe / mm	Best.-Nr.	€ / Stk / pcs.
0,422	50 x 30	10748-50	14,95
0,974	70 x 35	10748-70	17,95

Schlossgehäuse,
Links oder rechts verwendbar, 2-tourig
Boîtier en inox,
Disponible droite et gauche, à 2 tours.
Lock case,
Left or right side usage with 2-tours lock.



E = 72 mm, A = 60 mm

T x H x B /mm	Best.-Nr.	€/Stk. /pcs.
96 x 172 x 30	10201-30	20,95
96 x 172 x 34	10201-34	21,45
96 x 172 x 40	10201-40	21,95
96 x 172 x 50	10201-50	25,95

Schmales Schlossgehäuse,
Links oder rechts verwendbar, 1-tourig
Boîtier de serrure étroit,
Utilisable droite et gauche, serrure à un tour
Narrow lock case,
Left or right side usage with 1-tour lock

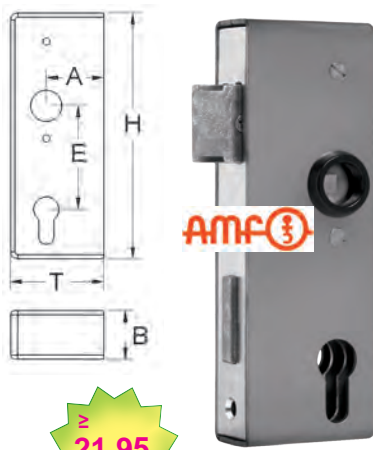

E = 72 mm, A = 40 mm

T x H x B /mm	Best.-Nr.	€/Stk. /pcs.
65 x 172 x 30	10230	21,95
65 x 172 x 40	10230-40	22,95

Schlossgehäuse,
Links oder rechts verwendbar, 2-tourig
Boîtier en inox,
Disponible droite et gauche, à 2 tours.
Lock case,
Left or right side usage with 2-tours lock.



E = 72 mm, A = 60 mm

T x H x B /mm	Best.-Nr.	€/Stk. /pcs.
96 x 172 x 30	10201-30-GTV	17,95
96 x 172 x 40	10201-40-GTV	18,95

Schlossgehäuse mit Hakenfalle
Boîtier de serrure à crochet pour porte coulissante
Lock case for sliding doors with hook



A = 60 mm

T x H x B /mm	Best.-Nr.	€/Stk. /pcs.
96 x 172 x 30	10250-30	43,95
96 x 172 x 34	10250-34	44,45
96 x 172 x 40	10250-40	45,95
96 x 172 x 50	10250-50	49,95

Schlossgehäuse mit Doppelzylinder
Boîtier de serrure à crochet pour porte coulissante
Lock case for sliding doors with hook



T x H x B /mm	Best.-Nr.	€/Stk. /pcs.
96 x 172 x 30	10201-30-D	49,95
96 x 172 x 34	10201-34-D	50,95
96 x 172 x 40	10201-40-D	51,95

Schlossgehäuse mit Hakenfalle und Doppelzylinder
Boîtier de serrure à crochet pour porte coulissante
Lock case for sliding doors with hook



T x H x B /mm	Best.-Nr.	€/Stk. /pcs.
96 x 172 x 30	10250-30-D	59,95
96 x 172 x 34	10250-34-D	59,95
96 x 172 x 40	10250-40-D	59,95

Schliesskasten zum Einbetonieren,
Gehäuse und Schliessblech
Gâche à encastrer pour béton,
Boîtier et platine de gâche
Striking box to set in concrete,
Lock case and striking plate



≥ **13,45**
€/Stk./pcs.

T x H x B /mm	Best.-Nr.	€/Stk. /pcs.
45 x 172 x 30	10210-30	13,45
45 x 172 x 34	10210-34	13,95
45 x 172 x 40	10210-40	14,45
45 x 172 x 50	10210-50	17,95

Gegenkasten,
Gehäuse und Schliessblech
Gâche,
Boîtier et platine de gâche
Striking case,
Lock case and striking plate



≥ **13,95**
€/Stk./pcs.

T x H x B /mm	Best.-Nr.	€/Stk. /pcs.
96 x 172 x 30	10221-30	13,95
96 x 172 x 34	10221-34	14,45
96 x 172 x 40	10221-40	14,95
96 x 172 x 50	10221-50	16,95

Schlossgehäuse,
Links oder rechts verwendbar, 1-tourig
Boîtier en inox,
Disponible droite et gauche, à 1 tours.
Lock case,
Left or right side usage with 1-tours lock.



≥ **29,95**
€/Stk./pcs.



Nouveau - New
Neu

A = 50 bzw. 60 mm
B = 30 bzw. 40 mm
C = 256 mm

Entfernung 92 mm. Links oder rechts verwendbar mit Wechsel. Gehäuse Eisen blank. Schliesskasten und Stulp verzinkt. Falle, Riegel und Nuss Zinkdruckguss. Riegel 1 Tour. Falle und Riegel 5 mm vorstehend. Profil 30 x 50 mm und 40 x 60. Zubehör: Je 2 Führungsringe (schwarz und grau), 4 Befestigungsschrauben.

Best.-Nr. 10234-30

Gegenkasten vorgerichtet für e-Öffner
Gâche avec fente pour ouverture de porte électrique
Striking box with slot for electric door opener

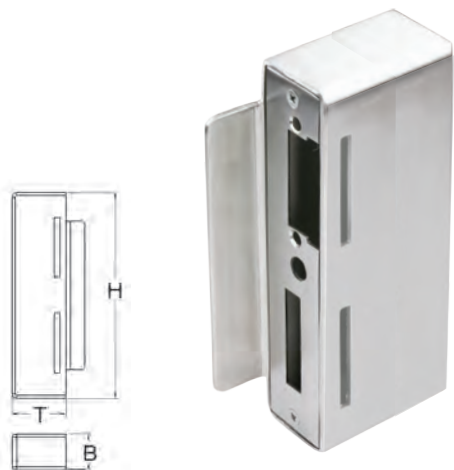

≥ **16,95**
€/Stk./pcs.

B x H = 96 mm x 172 mm

T x H x B /mm	Best.-Nr. DIN Rechts	€/Stk. /pcs.
96x172x30	10221-30-E	16,95
96x172x34	10221-34-E	17,45
96x172x40	10221-40-E	17,95
96x172x50	10221-50-E	19,95

Schliesskasten vorgerichtet für e-Öffner
Gâche avec fente pour ouverture de porte électrique
Striking box with slot for electric door opener

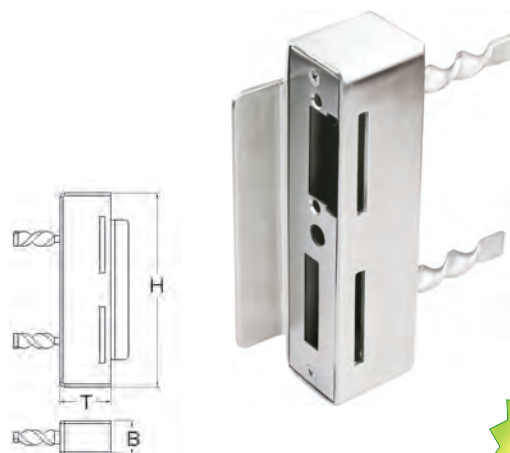

≥ **16,95**
€/Stk./pcs.

T x H x B /mm	Best.-Nr. DIN Rechts	€/Stk. /pcs.
45x172x30	10210-30-E	16,95
45x172x34	10210-34-E	17,45
45x172x40	10210-40-E	17,95
45x172x50	10210-50-E	19,95

Design-Schlossgehäuse,
Links oder rechts verwendbar, 2-tourig
Boîtier de serrure design ,
Disponible droite et gauche, à 2 tours.
Design lock case,
Left or right side usage with 2-tours lock.

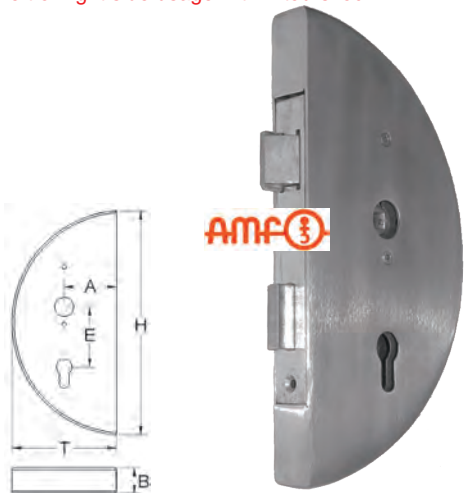

E = 72 mm, A = 60 mm

T x H x B /mm	Best.-Nr.	€/Stk. /pcs.
130 x 250 x 30	10203-30	29,95
130 x 250 x 34	10203-34	30,45
130 x 250 x 40	10203-40	30,95
130 x 250 x 50	10203-50	32,95

≥ **29,95**
€/Stk./pcs.

Design-Gegenkasten,
Links oder rechts verwendbar
Gâche design ,
Utilisable droite et gauche
Design striking case,
Left or right side usage

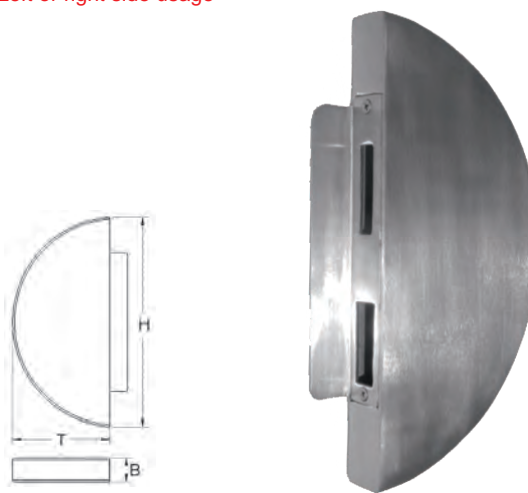

T x H x B /mm	Best.-Nr.	€/Stk. /pcs.
130 x 250 x 30	10223-30	23,95
130 x 250 x 34	10223-34	24,45
130 x 250 x 40	10223-40	24,95
130 x 250 x 50	10223-50	26,95

≥ **23,95**
€/Stk./pcs.

Design-Schlossgehäuse,
Links oder rechts verwendbar, 2-tourig
Boîtier de serrure design ,
Disponible droite et gauche, à 2 tours.
Design lock case,
Left or right side usage with 2-tours lock.



Anschluss "rund"
Fixation pour barreau
"Round" connection

øD in mm	T x H /mm	Best.-Nr.	€/Stk. /pcs.
42,4	130 x 250	10202-42	35,95
48,3	130 x 250	10202-48	36,95

≥ **35,95**
€/Stk./pcs.

Design-Gegenkasten,
Links oder rechts verwendbar
Gâche design ,
Utilisable droite et gauche
Design striking case,
Left or right side usage



Anschluss "rund"
Fixation pour barreau
"Round" connection

øD /mm	T x H /mm	Best.-Nr.	€/Stk. /pcs.
42,4	130 x 250	10222-42	26,95
48,3	130 x 250	10222-48	27,95

≥ **26,95**
€/Stk./pcs.

AK FER

Schloss & Zubehör Serrures & Accessoires / Locks & Accessories

Einsteckschloss – Lose
Serrure à encastrer
Mortise Lock



≥ **15,45**
€/Stk./pcs.

* Schmales Schlossgehäuse

Für/ for/ pour	Best.-Nr.	€/Stk./pcs.
10230*	10230-L	15,95
10230-40*	10230-40-L	16,95
10200-30	10200-30-L	15,45
10200-34	10200-34-L	15,45
10200-40	10200-40-L	15,45
10200-50	10200-50-L	17,45

Einsteckschloss mit Hakenfalle – Lose
Serrure à encastrer à crochet
Mortise lock for sliding doors with hook



≥ **33,95**
€/Stk./pcs.

Für/for/pour	Best.-Nr.	€/Stk./pcs.
10250-30	10250-30-L	33,95
10250-34	10250-34-L	33,95
10250-40	10250-40-L	33,95
10250-50	10250-50-L	36,95

Einsteckschloss mit Hakenfalle – Lose
Serrure à encastrer à crochet
Mortise lock for sliding doors with hook

Mit Hakenfalle und Wechsel. Stulp und Kasten verzinkt.
Falle und Nuss Temperguss verzinkt. Falle abschließbar.



≥ **19,95**
€/Stk./pcs.

Best.-Nr. 10236-30

Rohrrahmenschloss, verzinkt.
Serrure pour profils tubulaires, galvanisée.
Tubular frame lock, galvanised.

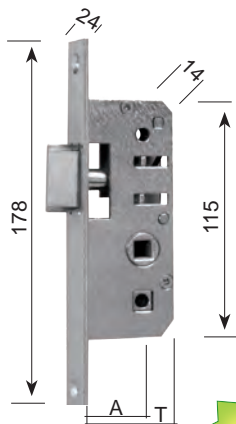

≥ **11,29**
€/Stk./pcs.



T /mm	A /mm	Best.-Nr.	€/Stk./pcs.
30,5	18	10235-18	11,29
36,5	24	10235-24	11,29
41,5	30	10235-30	11,29
46,5	35	10235-35	11,29
51,5	40	10235-40	11,29

Rohrrahmenschloss, verzinkt. 1-tourig
Serrure pour profils tubulaires, galvanisée.
1 tour
Tubular frame lock, galvanised. 1-tour

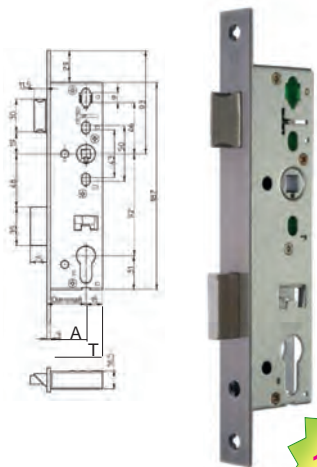

≥ **13,79**
€/Stk./pcs.

SSF

T /mm	A /mm	Best.-Nr.	€/Stk./pcs.
30,5	18	10233-18	13,79
36,5	24	10233-24	13,79
41,5	30	10233-30	13,79
46,5	35	10233-35	13,79
51,5	40	10233-40	13,79

Rohrrahmenschloss, verzinkt. 1-tourig
Serrure pour profils tubulaires, galvanisée. 1 tour
Tubular frame lock, galvanised. 1-tour

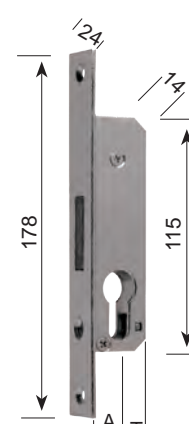

≥ **11,29**
€/Stk./pcs.



T	A	Best.-Nr.	€/Stk.
30,5	18	10232-18	11,29
36,5	24	10232-24	11,29
41,5	30	10232-30	11,29
46,5	35	10232-35	11,29
51,5	40	10232-40	11,29

E-mail: info@akbas-schmiedeeisen.de, www.akbas-schmiedeeisen.de

Tel: +49(0) 61 44 33 05-0, Fax: +49(0) 61 44 33 05-15

Tel: +33.3.68680131, E-mail: vente@akbas-schmiedeeisen.de, Tel: +44.151.6018946, E-mail: sales@akbas-schmiedeeisen.de

AK FER

Schloss & Zubehör Serrures & Accessoires / Locks & Accessories

Elektrischer Türöffner mit Entriegelung.
Links oder rechts verwendbar
Gâche électrique avec levier de déblocage.
Utilisable droite et gauche
Electric door opener with mechanical release.
Left or right side usage

24,95
€/Stk./pcs.



6-12V AC/DC,
67 x 16,5 x 28,5 mm

Best.-Nr. 10270



5,95
€/Stk./pcs.

Geeignet für
Rohr-
rahmen-
schloss

7,95
€/Stk./pcs.

Best.-Nr. 10233-24

Best.-Nr. 10233-E24

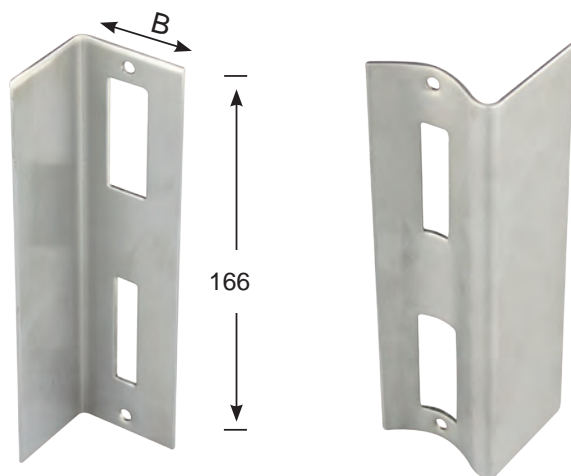

Geeignet für
AMF
Schloss-
gehäuse

≥ 3,95
€/Stk./pcs.

B /mm	Best.-Nr.	€/Stk./pcs.
30	10212-30	6,95
34	10212-34	6,95
40	10212-40	6,95

B /mm	Best.-Nr.	€/Stk./pcs.
33,7	10213-33,7	8,95
42,4	10213-42,4	8,95
48,3	10213-48,3	8,95

B /mm	Best.-Nr.	€/Stk./pcs.
30	10211-24	3,95
34	10211-28	3,95
40	10211-34	3,95

B /mm	Best.-Nr.	€/Stk./pcs.
30	10211E-24	4,95
34	10211E-28	4,95
40	10211E-34	4,95

A-Wechselstift, min M6-Gewinde
Rectangle, embout fileté M6
Spindle, with M6-thread and slotted edge

≥ 0,69
€/Stk./pcs.



A x L /mm	Best.-Nr.	Paket/Stk./ pcs.	€/Stk./ pcs.
8 x 80	B-8a/8x80	10	0,69
8 x 85	B-8a/8x85	10	0,69
8 x 95	B-8a/8x95	10	0,71
8 x 105	B-8a/8x105	10	0,74
8 x 115	B-8a/8x115	10	0,76

A-Vollstift, beidseitig gekerbt
Rectangle, fendu aux deux extrémités
Spindle, slotted at both edges



≥ 0,66
€/Stk./pcs.

A x L /mm	Best.-Nr.	Paket/Stk./ pcs.	€/Stk./ pcs.
8 x 80	B-ZH9a/8x80	10	0,66
8 x 100	B-ZH9a/8x100	10	0,81
8 x 130	B-ZH9a/8x130	10	0,92

Reduzierhülse
Manchon adapteur
Spindle adapter



≥ 0,46
€/Stk./pcs.

Abmessung /mm	Best.-Nr.	Paket/Stk./ pcs.	€/Stk./ pcs.
9 auf/to/en 8	B-ZH25/9-8	10	0,46
10 auf/to/en 8	B-ZH25/10-8	10	0,61

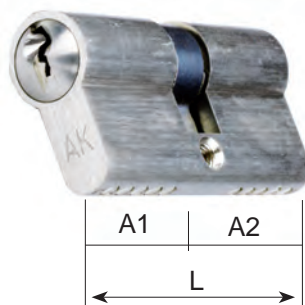

verschiedenschließend
système de clés multiples
different keying

≥ 4,79

€/Stk./pcs.

A1-A2 /mm	L /mm	Best.-Nr.	€/Stk./pcs	
			< 9	> 10
10-30	40	10240-1030	4,99	4,79
21-21	42	10240-2121	4,99	4,79
25-25	50	10240-2525	4,99	4,79
28-28	56	10240-2828	4,99	4,79
30-30	60	10240-3030	4,99	4,79
30-35	65	10240-3035	5,39	4,89
30-40	70	10240-3040	5,39	4,89
35-35	70	10240-3535	5,39	4,89
35-40	75	10240-3540	6,19	5,79
40-40	80	10240-4040	6,19	5,79

gleichschließend
serrures avec clés communes
cylinders with common keys

≥ 5,09

€/Stk./pcs.

A1-A2 /mm	L /mm	Best.-Nr.	€/Stk./pcs	
			< 9	> 10
10-30	40	10240-1030-G	5,29	5,09
21-21	42	10240-2121-G	5,29	5,09
25-25	50	10240-2525-G	5,29	5,09
28-28	56	10240-2828-G	5,29	5,09
30-30	60	10240-3030-G	5,29	5,09
30-35	65	10240-3035-G	5,69	5,49
30-40	70	10240-3040-G	6,19	5,99
35-35	70	10240-3535-G	6,19	5,99
35-40	75	10240-3540-G	6,49	6,29
40-40	80	10240-4040-G	6,49	6,29

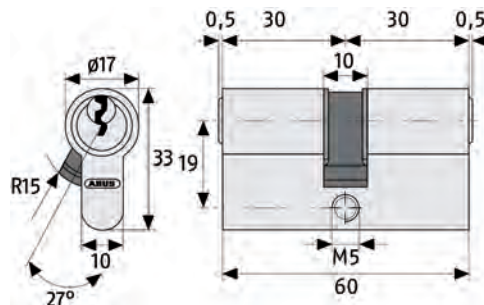

verschiedenschließend
système de clés multiples
different keying

≥ 7,79

€/Stk./pcs.

A1-A2 /mm	L /mm	Best.-Nr.	€/Stk./pcs	
			< 9	> 10
10-30	40	10241-1030	7,99	7,79
21-21	42	10241-2121	7,99	7,79
25-25	50	10241-2525	7,99	7,79
28-28	56	10241-2828	7,99	7,79
30-30	60	10241-3030	7,99	7,79
30-35	65	10241-3035	8,39	8,19
30-40	70	10241-3040	8,39	8,19
35-35	70	10241-3535	8,39	8,19
35-40	75	10241-3540	9,29	9,09
40-40	80	10241-4040	9,29	9,09

gleichschließend
serrures avec clés communes
cylinders with common keys

≥ 8,29

€/Stk./pcs.

A1-A2 /mm	L /mm	Best.-Nr.	€/Stk./pcs	
			< 9	> 10
10-30	40	10241-1030-G	8,49	8,29
21-21	42	10241-2121-G	8,49	8,29
25-25	50	10241-2525-G	8,49	8,29
28-28	56	10241-2828-G	8,49	8,29
30-30	60	10241-3030-G	8,49	8,29
30-35	65	10241-3035-G	8,89	8,69
30-40	70	10241-3040-G	8,89	8,69
35-35	70	10241-3535-G	8,89	8,69
35-40	75	10241-3540-G	9,79	9,59
40-40	80	10241-4040-G	9,79	9,59

E-mail: info@akbas-schmiedeeisen.de, www.akbas-schmiedeeisen.de

Tel: +49(0) 61 44 33 05-0, Fax: +49(0) 61 44 33 05-15

Tel: +33.3.68680131, E-mail: vente@akbas-schmiedeeisen.de, Tel: +44.151.6018946, E-mail: sales@akbas-schmiedeeisen.de

AK ALU

Aluminium - Beschläge
Poignées en aluminium / Aluminium handles



Best.-Nr. **B-113**
L x T = 125 x 53 mm
4,49 €/Paar/Set
> 10 **4,19** €/Paar/Set



Best.-Nr. **B-471**
L x T = 125 x 55 mm
4,99 €/Paar/Set
> 10 **4,49** €/Paar/Set



Best.-Nr. **B-171**
L x T = 125 x 53 mm
5,79 €/Paar/Set
> 10 **5,29** €/Paar/Set



Best.-Nr. **B-290**
L x T = 135 x 55 mm
6,49 €/Paar/Set
> 10 **5,99** €/Paar/Set



Best.-Nr. **B-1510**
L x T = 125 x 53 mm
5,59 €/Paar/Set
> 10 **5,09** €/Paar/Set

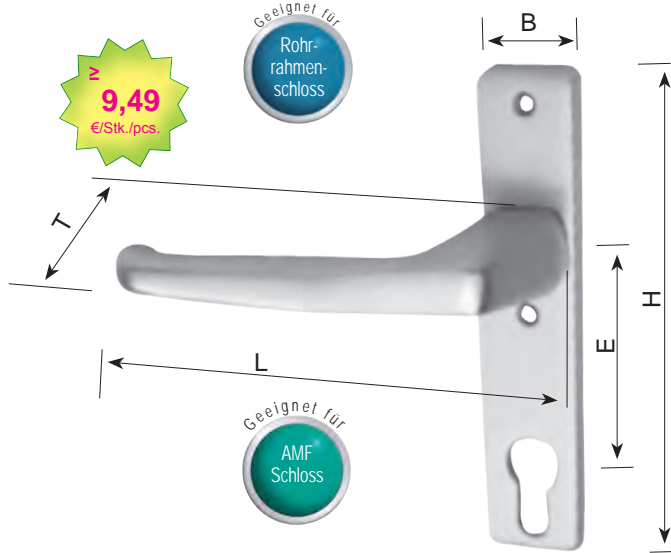

L x T /mm	B x H /mm	E /mm	Best.-Nr.	€/ Stk / pcs. < 5	> 5
135 x 55	32 x 155	72	B-290/21-D	9,79	9,49
135 x 55	32 x 204	92	B-290/20-HD	9,99	9,69

F1 = Farbe / Couleur / Colour
8 mm = Stift / Branches quadrangulaires / Profile spindles
F = Fest / Fix / Fix
D = Drehbar / Rotative / Non-Fixed
LxT = Mass Drücker / Dimension de la poignée / Handle Size
BxH = Mass Schild / Dimensions de la plaque / Plate Size



L x T /mm	B x H /mm	E /mm	Best.-Nr.	€/ Stk / pcs. < 5	> 5
135 x 55	32 x 155	72	B-471/21-D	9,39	8,99
135 x 55	32 x 204	92	B-471/20-HD	9,99	9,69

Aluminium

Top

AK ALU

Aluminium - Beschläge Poignées en aluminium / Aluminium handles



Geeignet für AMF Schloss

≥ 9,69 €/Stk./pcs.

B x H = 32 x 155 mm
E = 72 mm

Best.-Nr.	€/Stk./pcs	
	< 4	> 5
B-307-21 F	9,99	9,69
B-307-21 D	9,99	9,69



≥ 9,99 €/Stk./pcs.

L x T = ø 50 mm
B x H = 32 x 155 mm
E = 72 mm

Geeignet für AMF Schloss

Best.-Nr.	€/Stk./pcs	
	< 4	> 5
B-271-21 F	10,99	9,99
B-271-21 D	10,99	9,99



≥ 11,19 €/Stk./pcs.

L x T = ø 50 mm
B x H = 31 x 204 mm
E = 92 mm

Geeignet für Rohr-rahmen-schloss

Best.-Nr.	€/Stk./pcs	
	< 4	> 5
B-271-20 HF	13,69	12,69
B-271-20 HD	13,69	12,69

F1 = Farbe / Couleur / Colour
8 mm = Stift / Branches quadrangulaires / Profile spindles
F = Fest / Fix / Fix
D = Drehbar / Rotative / Non-Fixed
LxT = Mass Drücker / Dimension de la poignée / Handle Size
BxH = Mass Schild / Dimensions de la plaque / Plate Size



≥ 8,49 €/Stk./pcs.

L x T = ø 50 mm
B x H = 32 x 155 mm
E = 72 mm

Geeignet für AMF Schloss

Best.-Nr.	€/Stk./pcs	
	< 4	> 5
B-306-21 F	8,79	8,49
B-306-21 D	8,79	8,49

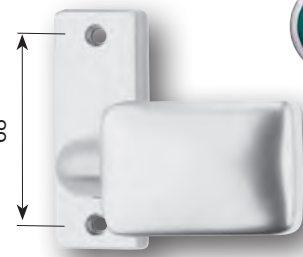

≥ 9,79 €/Stk./pcs.

B x H = 32 x 85 mm

Geeignet für AMF Schloss

Best.-Nr.	€/Stk./pcs	
	< 4	> 5
B-273/225-F	9,99	9,79
B-273/225-D	9,99	9,79



≥ 9,79 €/Stk./pcs.

L x T = ø 50 mm
B x H = 31 x 204 mm
E = 92 mm

Geeignet für Rohr-rahmen-schloss

Best.-Nr.	€/Stk./pcs	
	< 4	> 5
B-306-20 HF	9,99	9,69
B-306-20 HD	9,99	9,69

E-mail: info@akbas-schmiedeeisen.de, www.akbas-schmiedeeisen.de

Tel: +49(0) 61 44 33 05-0, Fax: +49(0) 61 44 33 05-15

Tel: +33.3.68680131, E-mail: vente@akbas-schmiedeeisen.de, Tel: +44.151.6018946, E-mail: sales@akbas-schmiedeeisen.de

AK ALU

Akhas
Schmiedeeisen & Metallwaren



L x T = ø 50 mm
B x H = ø 60 mm

Best.-Nr.	€/Stk./pcs	
	< 4	> 5
B-306-F	5,99	5,79
B-306-D	5,99	5,79

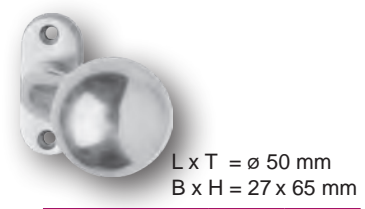

L x T = ø 50 mm
B x H = 27 x 65 mm

Best.-Nr.	€/Stk./pcs	
	< 4	> 5
B-271/10-50F	11,99	11,49
B-271/10-50D	11,99	11,49

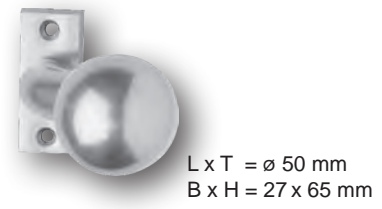

L x T = ø 50 mm
B x H = 27 x 65 mm

Best.-Nr.	€/Stk./pcs	
	< 4	> 5
B-271/11-50F	11,99	11,49
B-271/11-50D	11,99	11,49



L x T = ø 50 mm
B x H = 27 x 65 mm

Best.-Nr.	€/Stk./pcs	
	< 4	> 5
B-306-10 F	6,19	5,99
B-306-10 D	6,19	5,99

F = Fest / Fix / Fix
D = Drehbar / Rotative / Non-Fixed

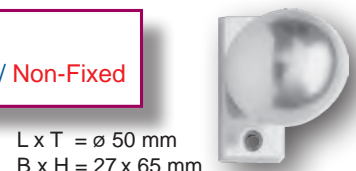

L x T = ø 50 mm
B x H = 27 x 65 mm

Best.-Nr.	€/Stk./pcs	
	< 4	> 5
B-306-11 F	6,19	5,99
B-306-11 D	6,19	5,99

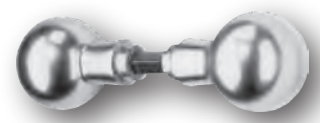

L x T = ø 50 mm

Best.-Nr.	€/Stk./pcs	
	< 4	> 5
B-306	9,99	9,79

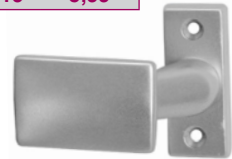

B x H = 27 x 65 mm

Best.-Nr.	€/Stk./pcs	
	< 4	> 5
B-273/11-50F	9,99	9,79
B-273/11-50D	9,99	9,79

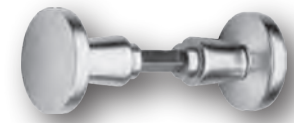
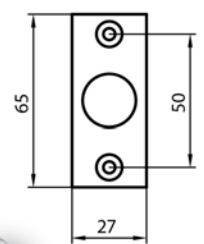

L x T = ø 50 mm

Best.-Nr.	€/Stk./pcs	
	< 4	> 5
B-307	9,99	9,79



L x T = ø 50 mm

Best.-Nr.	€/Stk./pcs	
	< 4	> 5
B-307-F	6,19	5,99
B-307-D	6,19	5,99

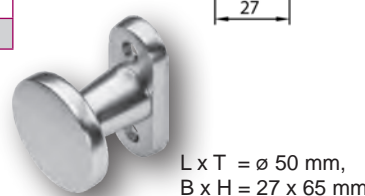

L x T = ø 50 mm,
B x H = 27 x 65 mm

Best.-Nr.	€/Stk./pcs	
	< 4	> 5
B-307-10 F	6,19	5,99
B-307-10 D	6,19	5,99



L x T = ø 50 mm
B x H = 27 x 65 mm

Best.-Nr.	€/Stk./pcs	
	< 4	> 5
B-307-11 F	6,19	5,99
B-307-11 D	6,19	5,99

AK ALU

Aluminium-Rosetten
Rosaces aluminium / Aluminium rosettes



Best.-Nr. **B-239-N**
Ø 52 mm,
1,19 €/Stk./pcs.



Best.-Nr. **B-231**
B x H = 27 x 65 mm,
1,09 €/Stk./pcs.

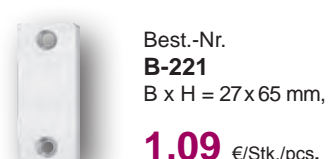

Best.-Nr. **B-221**
B x H = 27 x 65 mm,
1,09 €/Stk./pcs.

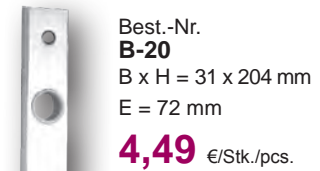

Best.-Nr. **B-20**
B x H = 31 x 204 mm
E = 72 mm
4,49 €/Stk./pcs.



Best.-Nr. **B-237-N**
Ø 52 mm,
1,19 €/Stk./pcs.



Best.-Nr. **B-233**
B x H = 27 x 65 mm,
1,09 €/Stk./pcs.

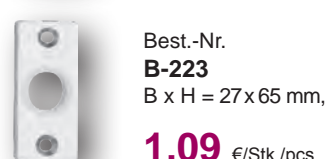

Best.-Nr. **B-223**
B x H = 27 x 65 mm,
1,09 €/Stk./pcs.



Best.-Nr. **B-20 HD**
E = 92 mm
4,49 €/Stk./pcs.



Best.-Nr. **B-238-N**
Ø 52 mm,
1,19 €/Stk./pcs.



Best.-Nr. **B-232**
B x H = 27 x 65 mm,
1,09 €/Stk./pcs.

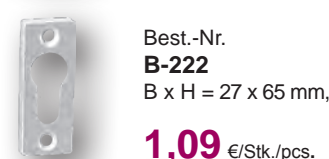

Best.-Nr. **B-222**
B x H = 27 x 65 mm,
1,09 €/Stk./pcs.



Best.-Nr. **B-21-D**
B x H = 32 x 155 mm,
E = 72 mm
3,49 €/Stk./pcs.

Hilfs- und Befestigungsmittel
Autres articles de montage / Additives & Fasteners

Akbas

Schmiedeeisen & Metallwaren

Betonschraube V4A, hartmetallbestückt in Sechskant
Vis à béton V4A, carbure à Allen
Concrete screw V4A, carbide tipped in Allen

1	2	3	4	5	6	Best.-Nr.	€/Stk. /pcs.
Ø10	80	15	75	8	65	S-Beton10	1,49
Ø12	100	15	95	10	85	S-Beton12	2,19

- 1 Schrauben Ø
- 2 Gesamtlänge / mm
- 3 Klemmstärke / mm
- 4 Bohrlöchtiefe / mm
- 5 Bohrdurchmesser / mm
- 6 Mindestverankerungstiefe



axe, - et distances aux bords! minor axis, - and edge distances!
geringe Achs,- und Randabstände!

≥ 1,49 €/Stk./pcs.

Schneidet das Gewinde in den Beton - ohne Dübel anwendung!
Couper le fil dans le béton - assembler sans chevilles
Cut the thread into the concrete - Assemble without plugs



Europäisch Technische Zulassung Option 1 für gerissenen Beton.
Edelstahl A4 / Hartmetall bestückt.

MULTI-MONTI MMS-SS
Betonschraube verzinkt, hartmetallbestückt in Sechskant
Vis à béton, carbure à Allen
Concrete screw, carbide tipped in Allen

1	2	3	4	5	Inhalt	Best.-Nr.	€/Pack.
Ø 7,5	60	5	x	6	50	S-Beton-St8	10,99
Ø10	80	15	75	8	25	S-Beton-St10	11,99
Ø12	90	15	85	10	25	S-Beton-St12	14,99

- 1 Schrauben Ø
- 2 Gesamtlänge / mm
- 3 Klemmstärke / mm
- 4 Bohrlöchtiefe / mm
- 5 Bohrdurchmesser / mm
- 6 Mindestverankerungstiefe

Verkauf nur in geschlossenen Packungen
Vendu uniquement sous emballage
Only sold with closed package

geringe Achs,- und Randabstände!

Schneidet das Gewinde in den Beton - ohne Dübel Anwendung!

≥ 10,99 €/Pack



Europäisch Technische Zulassung Option 1 für gerissenen Beton.

Stahlbolzen / Goujon en acier / Through bolt anchors

- Europäisch Technische Zulassung Option 1 für gerissenen und ungerissenen Beton
- Nichtrostender Stahl A4/316
- Standard européen option1 pour béton fissuré et non fissuré
- Inox A4/316
- European Technical Approval Option 1 for cracked and uncracked concrete
- Stainless steel A4/316

Verkauf nur in geschlossenen Packungen
Vendu uniquement sous emballage
Only sold with closed package

≥ 0,94 €/Stk./pcs.

Top



Best.-Nr.	1	2	3	4	5	6	€/Stk. /pcs.
S-KDK-E 8-15/80	8	80	65	15	50	400	0,94
S-KDK-E 10-10/80	10	80	70	10	50	250	0,99
S-KDK-E 10-30/112	10	112	75	30	25	200	1,29
S-KDK-E 12-20/115	12	115	90	12	25	125	1,89

Stahlbolzen / Goujon en acier / Through bolt anchors

- Europäisch Technische Zulassung Option 7 für ungerissenen Beton
- Galvanisch verzinkt > 5 µm
- Standard européen option 7 pour béton non fissuré
- Galvanisé > 5 µm
- European Technical Approval Option 7 for uncracked concrete
- Zinc plated > 5 µm

Verkauf nur in geschlossenen Packungen
Vendu uniquement sous emballage
Only sold with closed package

≥ 0,29 €/Stk./pcs.

Top



Best.-Nr.	1	2	3	4	5	6	€/Stk. /pcs.
S-KDK 8-15/80	8	80	65	15	50	400	0,29
S-KDK 10-10/80	10	80	70	10	50	250	0,35
S-KDK 10-30/112	10	112	75	30	25	200	0,38
S-KDK 12-20/115	12	115	90	12	25	125	0,44

E-mail: info@akbas-schmiedeeisen.de, www.akbas-schmiedeeisen.de

Tel: +49(0) 61 44 33 05-0, Fax: +49(0) 61 44 33 05-15

Tel: +33.3.68680131, E-mail: vente@akbas-schmiedeeisen.de, Tel: +44.151.6018946, E-mail: sales@akbas-schmiedeeisen.de

≥ **0,29**
€/Stk./pcs.

mungo
swiss made



m2 Stahlbolzen Goujon en acier / Through bolt anchors

- Europäisch Technische Zulassung Option 7 für ungerissenen Beton
- Galvanisch verzinkt > 5 µm
- Standard européen option 7 pour béton non fissuré
- Galvanisé > 5 µm
- European Technical Approval Option 7 for uncracked concrete
- Zinc plated > 5 µm

Verkauf nur in geschlossenen Packungen
Vendu uniquement sous emballage
Only sold with closed package

Verzinkt

Best.-Nr.	1	2	3	4	5	6	€/Stk./pcs.
3200885	8	85	50	15	100	300	0,29
3201009	10	95	58	15	100	300	0,34
3201011	10	110	58	30	50	150	0,39
3201211	12	110	68	15	50	150	0,44
3201212	12	125	68	30	50	150	0,49

- 1- Dübel & Bohr ø/mm / Forage et cheville ø/mm / Plug & drill ø/mm
- 2- Dübellänge mm / Longueur mm / Length mm
- 3- eff.Verankerungstiefe/mm / Profondeur d'ancrage maximum / Usable length mm
- 4- Nutzlänge mm / Profondeur d'ancrage minimum / Setting depth min. mm
- 5- Verpackt zu Stück / Pièces par lot / Box contents
- 6- Sammelkarton Stk. / Grand lot / Outer carton

≥ **0,99**
€/Stk./pcs.

mungo
swiss made



m2r Stahlbolzen rostfrei A4 Goujon inox A4 / Throughbolt, stainless steel A4

- Europäisch Technische Zulassung Option 7 für ungerissenen Beton
- Nichtrostender Stahl A4/316
- Standard européen option 7 pour béton non fissuré
- Inox A4/316
- European Technical Approval Option 7 for uncracked concrete
- Stainless steel A4/316

Verkauf nur in geschlossenen Packungen
Vendu uniquement sous emballage
Only sold with closed package



Best.-Nr.	1	2	3	4	5	6	€/Stk./pcs.
3300885	8	85	50	15	100	300	0,99
3301009	10	95	58	15	100	300	0,99
3301011	10	110	58	30	50	150	1,29
3301211	12	110	68	15	50	150	1,39
3301212	12	125	68	30	50	150	1,89

- 1- Dübel & Bohr ø/mm / Forage et cheville ø/mm / Plug & drill ø/mm
- 2- Dübellänge mm / Longueur mm / Length mm
- 3- eff.Verankerungstiefe/mm / Profondeur d'ancrage maximum / Usable length mm
- 4- Nutzlänge mm / Profondeur d'ancrage minimum / Setting depth min. mm
- 5- Verpackt zu Stück / Pièces par lot / Box contents
- 6- Sammelkarton Stk. / Grand lot / Outer carton

AK-EQUIP



mungo
swiss made



m1t Stahlbolzen Goujon en acier / Through bolt anchors

- Europäisch Technische Zulassung Option 1 für ungerissenen Beton
- Galvanisch verzinkt > 5 µm
- Standard européen option 1 pour béton non fissuré
- Galvanisé > 5 µm
- European Technical Approval Option 1 for uncracked concrete
- Zinc plated > 5 µm

Verkauf nur in geschlossenen Packungen
Vendu uniquement sous emballage
Only sold with closed package

Verzinkt

≥ **0,54**
€/Stk./pcs.

Nouveau - New
Neu

Best.-Nr.	1	2	3	4	5	6	€/Stk./pcs.
3801009	10	95	58	15	100	300	0,54
3801211	12	110	68	15	50	150	0,74

- 1- Dübel & Bohr ø/mm / Forage et cheville ø/mm / Plug & drill ø/mm
- 2- Dübellänge mm / Longueur mm / Length mm
- 3- eff.Verankerungstiefe/mm / Profondeur d'ancrage maximum / Usable length mm
- 4- Nutzlänge mm / Profondeur d'ancrage minimum / Setting depth min. mm
- 5- Verpackt zu Stück / Pièces par lot / Box contents
- 6- Sammelkarton Stk. / Grand lot / Outer carton



mungo
swiss made



m1tr Stahlbolzen rostfrei A4 Goujon inox A4 / Throughbolt, stainless steel A4

- Europäisch Technische Zulassung Option 1 für ungerissenen Beton
- Nichtrostender Stahl A4/316
- Standard européen option 1 pour béton non fissuré
- Inox A4/316
- European Technical Approval Option 1 for uncracked concrete
- Stainless steel A4/316

Verkauf nur in geschlossenen Packungen
Vendu uniquement sous emballage
Only sold with closed package



≥ **1,19**
€/Stk./pcs.

Nouveau - New
Neu

Best.-Nr.	1	2	3	4	5	6	€/Stk./pcs.
3901009	10	95	58	15	100	300	1,19
3901211	12	110	68	15	50	150	1,59

- 1- Dübel & Bohr ø/mm / Forage et cheville ø/mm / Plug & drill ø/mm
- 2- Dübellänge mm / Longueur mm / Length mm
- 3- eff.Verankerungstiefe/mm / Profondeur d'ancrage maximum / Usable length mm
- 4- Nutzlänge mm / Profondeur d'ancrage minimum / Setting depth min. mm
- 5- Verpackt zu Stück / Pièces par lot / Box contents
- 6- Sammelkarton Stk. / Grand lot / Outer carton

MIT-SE Polyester-Mörtel, styrofrei
Eigenschaften
• Europäische Technische Zulassung
Option 7 für ungerissenen Beton
• Bauaufsichtlich zugelassen für Mauerwerk
• Brandschutzprüfung F30-F120
• Keine Geruchsbelastung da styrofrei
• Mörtelfarbe grau
Anwendungen
Stahlkonstruktionen, Holzkonstruktionen, Fassaden, Fassadengerüste, Geländer, Hochregale



MIT-SE Mortier polyester, sans styrène
Caractères
• Agrément technique européen option 7 pour béton non fissuré
• Résistance au feu jusqu'à F120
• Sans styrène - pas de gêne due à une odeur
• Couleur de mortier: gris
Applications
constructions métalliques, constructions en bois, façades, échafaudages, garde-corps, rayonnages hauts

MIT-SE Polyester mortar, styrene free
Features Features
• European Technical Approval Option 7 for uncracked concrete
• Fire resistance classification F30-F120
• Low odour
• Colour of mortar: grey
Applications
steel constructions, wooden constructions, facades, facade scaffolds, railings, high-racks

Verbundmörtel MIT-SE Plus

350 ml
Best.-Nr. 1710025

300 ml
Best.-Nr. 1710017*
* passend zur Silikonpistole !



Kartusche incl. 2 Mischer
Cartouche avec deux mélangeurs / Cartridge incl. 2 mixers

Inhalt / ml	Best.-Nr.	€/Stk.	€/Stk im Karton 12 Stk
300	1710017	9,99	8,99
350	1710025	9,99	8,99

≥ 8,99
€/Stk./pcs.

	6÷10°C	11÷15°C	16÷20°C	21÷25°C	26÷30°C	31÷35°C
Verarbeitung / Traitement Working / Funzionamento	25 Min.	15 Min.	6 Min.	4 Min.	3 Min.	2 Min.
Aushärtung / Prise Hardening / Irrigidimento	120 Min.	80 Min.	50 Min.	35 Min.	30 Min.	25 Min.

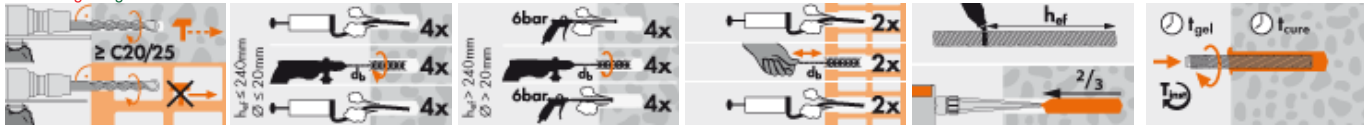

Auspresspistole MIT
Pistolet à cartouches MIT
Injection gun MIT



Best.-Nr. 1710033
25,99 €/Stk./pcs.

Universal-Siebhülse
Manchon universel
Universal sleeve

für / pour / for M10, M12

Best.-Nr.
S-SHK 15x85
ø 15 x 85 mm **4,99** €/20 Stk./20 pcs.

Best.-Nr.
S-SHK 15x130
ø 15 x 130 mm **5,99** €/20Stk./20 pcs.

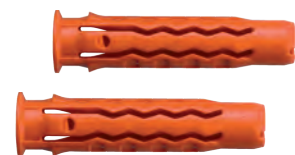

MQ Quattro Nypondübel
Chevilles en nylon
Nylon plug

Geprüfter Dübelwerkstoff

- Aus hochwertigem Polyamid PA 6 gefertigt
- Réalisé en polyamide 6 de haute qualité
- Made from high-quality polyamide PA 6
- Prodotto d'alta qualità in polyammide PA6



Schraubentyp Holz/Span
Type de vis bois
Screw type wood/chipboard

Schraubentyp metrisch
Screw type metric
Type de vis métrique

	5	25	2,6 - 4	M3	100	1,29
1050050	6	30	3,5 - 5	M4	100	1,79
1050080	8	40	4,5 - 6	M5	100	2,39
1050100	10	50	6 - 8	M6	50	2,39
1050120	12	60	8 - 10	M8	25	2,09
1050140	14	70	10 - 12	M10	20	2,69

E-mail: info@akbas-schmiedeeisen.de, www.akbas-schmiedeeisen.de

Tel: +49(0) 61 44 33 05-0, Fax: +49(0) 61 44 33 05-15

Tel: +33.3.68680131, E-mail: vente@akbas-schmiedeeisen.de, Tel: +44.151.6018946, E-mail: sales@akbas-schmiedeeisen.de



Linsenkopfblechschraben mit Innenvielzahn, nach DIN 7983 in A2

d/mm	L-l/mm	Best.-Nr.	€/Stk./pcs.100
3,9	40	S7983-3,9 x 40	2,99
3,9	50	S7983-3,9 x 50	3,79
3,9	60	S7983-3,9 x 60	4,29
4,8	50	S7983-4,8 x 50	4,99
4,8	60	S7983-4,8 x 60	5,99
4,8	70	S7983-4,8 x 70	6,99
5,5	50	S7983-5,5 x 50	7,29
5,5	60	S7983-5,5 x 60	8,49
5,5	70	S7983-5,5 x 70	9,29
6,3	50	S7983-6,3 x 50	9,99
6,3	60	S7983-6,3 x 60	10,49
6,3	70	S7983-6,3 x 70	10,99



Linsenkopfblechschraben mit Kreuzschlitz, nach DIN 7983 in A2

d/mm	L-l/mm	Best.-Nr.	€/Stk./pcs.100
3,9	40	S7983Z-3,9 x 40	2,99
3,9	50	S7983Z-3,9 x 50	3,79
3,9	60	S7983Z-3,9 x 60	4,29
4,8	50	S7983Z-4,8 x 50	4,99
4,8	60	S7983Z-4,8 x 60	5,99
4,8	70	S7983Z-4,8 x 70	6,99
5,5	50	S7983Z-5,5 x 50	7,29
5,5	60	S7983Z-5,5 x 60	8,49
5,5	70	S7983Z-5,5 x 70	9,29
6,3	50	S7983Z-6,3 x 50	9,99
6,3	60	S7983Z-6,3 x 60	10,49
6,3	70	S7983Z-6,3 x 70	10,99



Linsenkopfblechschraben mit Kreuzschlitz, nach DIN 7981 in A2

d/mm	L-l/mm	Best.-Nr.	€/Stk./pcs.100
3,9	40	S7981-3,9 x 40	2,99
3,9	50	S7981-3,9 x 50	3,79
3,9	60	S7981-3,9 x 60	4,29
4,8	50	S7981-4,8 x 50	4,99
4,8	60	S7981-4,8 x 60	5,99
4,8	70	S7981-4,8 x 70	6,99
5,5	50	S7981-5,5 x 50	7,29
5,5	60	S7981-5,5 x 60	8,49
5,5	70	S7981-5,5 x 70	9,29
6,3	50	S7981-6,3 x 50	9,99
6,3	60	S7981-6,3 x 60	10,49
6,3	80	S7981-6,3 x 80	10,99

Karoseriescheiben nach DIN 9021 in A2

für	d2/mm	Best.-Nr.	€/Stk./pcs.100
M 4	12	S9021-4	1,59
M 5	15	S9021-5	1,79
M 6	18	S9021-6	1,99
M 8	24	S9021-8	2,49
M 10	30	S9021-10	4,39
M 12	37	S9021-112	7,499

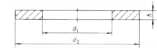
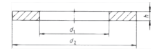

Unterlegscheiben Form A (ohne Fase) nach DIN 125 in A2

für	d2/mm	Best.-Nr.	€/Stk./pcs.100
M 6	12	S125-6	1,49
M 8	16	S125-8	1,99
M 10	20	S125-10	3,89
M 12	24	S125-12	6,99

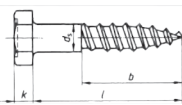
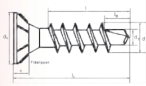

Senkkopf-Spanplattenschrauben mit Innenvielzahn und Bohrspitze, in A2

d/mm	L-l/mm	Best.-Nr.	€/Stk./pcs.100
4	30-18	S9044-4 x 30	4,35
4	35-24	S9044-4 x 35	4,45
4	40-24	S9044-4 x 40	4,75
4	45-30	S9044-4 x 45	4,95
4	50-30	S9044-4 x 50	5,95
4,5	40-24	S9044-4,5 x 40	5,95
4,5	50-30	S9044-4,5 x 50	6,95
4,5	60-40	S9044-4,5 x 60	7,45
5	40-24	S9044-5 x 40	7,25
5	50-30	S9044-5 x 50	7,45
5	70-50	S9044-5 x 70	9,45
5	80-60	S9044-5 x 80	11,95
6	80-60	S9044-6 x 80	16,95
6	100-60	S9044-6 x 100	21,95

Sechskant-Holzschrauben nach DIN 571 in A2

d/mm	l/mm	Best.-Nr.	€/Stk./pcs.
5	50	S571-5 x 50	0,12
5	60	S571-5 x 60	0,14
6	50	S571-6 x 50	0,13
6	60	S571-6 x 60	0,14
6	70	S571-6 x 70	0,17
6	80	S571-6 x 80	0,18
8	60	S571-8 x 60	0,26
8	80	S571-8 x 80	0,32
8	100	S571-8 x 100	0,42
10	60	S571-10 x 60	0,45
10	80	S571-10 x 80	0,56
10	100	S571-10 x 100	0,69
10	120	S571-10 x 120	0,79



Stockschrauben mit Holz- und ISO-Gewinde in A2

d/mm	l/mm	Best.-Nr.	€/Stk./pcs.
M 6	50	S9082-6 x 50	0,19
M 6	60	S9082-6 x 60	0,21
M 6	70	S9082-6 x 70	0,22
M 8	60	S9082-8 x 60	0,31
M 8	80	S9082-8 x 80	0,41
M 8	100	S9082-8 x 100	0,54
M 10	80	S9082-10 x 80	0,59
M 10	100	S9082-10 x 100	0,69
M 10	120	S9082-10 x 120	0,99
M 12	80	S9082-12 x 80	1,19

Sicherheitsschrauben "SG-FIXI"

verzinkt / zingué / galvanized



Sechskantbolzen



Abmessung/mm	Best.-Nr.	€/Stk./pcs.
8 x 50	12400	0,99
8 x 70	12401	1,05
8 x 90	12402	1,09
10 x 80	12403	1,19
10 x 100	12404	1,27
10 x 130	12405	1,32

V2A-Schrauben
Vis inox 304 / Inox 304 screws

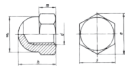

Sechskant-Hutmuttern,
nach DIN 1587 in A2



d/mm	h/mm	Best.-Nr.	€/Stk./pcs.
M 5	10	S1587-M 5	0,11
M 6	12	S1587-M 6	0,13
M 8	15	S1587-M 8	0,18
M 10	18	S1587-M 10	0,29
M 12	22	S1587-M 12	0,44

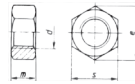

Sechskantmuttern, nach DIN 934 in A2

d/mm	Best.-Nr.	€/Stk./pcs.
M5	S934-M5	0,04
M6	S934-M 6	0,06
M8	S934-M8	0,08
M10	S934-M10	0,12
M12	S934-M12	0,18

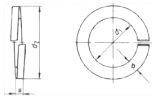

Federringe Form B (glatt)
nach DIN 127 in A2



für	d2/mm	Best.-Nr.	€/Stk./ pcs.100
M 6	11,8	S127-6	1,49
M 8	14,8	S127-8	1,99
M 10	18,1	S127-10	2,99
M 12	21,1	S127-12	4,49



Gewindestifte mit Innensechskant und
Kegelkuppe nach DIN 913 in A2

d/mm	l/mm	Best.-Nr.	€/100Stk./ pcs.
M 5	6	S913-5 x 6	3,49
M 5	8	S913-5 x 8	3,99
M 5	10	S913-5 x 10	3,99
M 6	6	S913-6 x 6	3,99
M 6	10	S913-6 x 10	4,29
M 6	20	S913-6 x 20	5,95
M 8	10	S913-8 x 10	4,95
M 8	20	S913-8 x 20	6,95

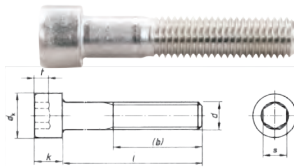

Zylinderschrauben mit Innensechskant
nach DIN 912 in A2

d/mm	l/mm	Best.-Nr.	€/Stk./pcs.
M 6	20	S912-6 x 20	0,10
M 6	30	S912-6 x 30	0,12
M 8	20	S912-8 x 20	0,17
M 8	30	S912-8 x 30	0,20
M 8	40	S912-8 x 40	0,27
M 10	30	S912-10 x 30	0,33
M 10	40	S912-10 x 40	0,39
M 10	50	S912-10 x 50	0,49
M 12	30	S912-12 x 30	0,56
M 12	40	S912-12 x 40	0,59
M 12	60	S912-12 x 60	0,79

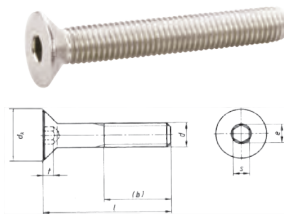

Senkschrauben mit Innensechskant nach
DIN 7991 in A2

d/mm	l/mm	Best.-Nr.	€/Stk./pcs.
M 5	10	S7991-5 x 10	0,07
M 5	20	S7991-5 x 20	0,09
M 6	10	S7991-6 x 10	0,09
M 6	16	S7991-6 x 16	0,09
M 6	20	S7991-6 x 20	0,11
M 6	30	S7991-6 x 30	0,12
M 8	16	S7991-8 x 16	0,14
M 8	30	S7991-8 x 30	0,19
M 8	50	S7991-8 x 50	0,29
M 10	30	S7991-10 x 30	0,29
M 10	50	S7991-10 x 50	0,42
M 10	70	S7991-10 x 70	0,59

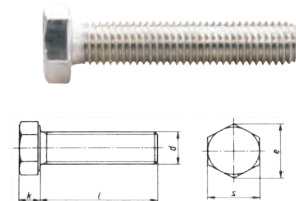

Sechskantschrauben mit Gewinde
nach DIN 933 in A2

d/mm	l/mm	Best.-Nr.	€/Stk./pcs.
M 6	20	S933-6 x 20	0,09
M 6	25	S933-6 x 25	0,11
M 6	30	S933-6 x 30	0,12
M 8	20	S933-8 x 20	0,16
M 8	30	S933-8 x 30	0,18
M 8	40	S933-8 x 40	0,20
M 10	30	S933-10 x 30	0,29
M 10	50	S933-10 x 50	0,39
M 12	30	S933-12 x 30	0,40
M 12	40	S933-12 x 40	0,49
M 12	50	S933-12 x 50	0,59
M 12	60	S933-12 x 60	0,69

Gewindestangen, Länge l=1 m
nach DIN 975 in A2

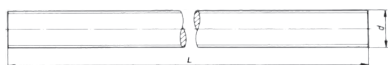

d/mm	l/mm	Best.-Nr.	€/Stk./pcs.
M 5	1000	S975-M 5	1,69
M 6	1000	S975-M 6	1,89
M 8	1000	S975-M 8	2,99
M 10	1000	S975-M 10	4,79
M 12	1000	S975-M 12	5,99



AK EQUIP

Hilfs- und Befestigungsmittel Autres articles de montage / Additives & Fasteners



nur **149,95**
Euro

GO-10-SP (Set) Zweihand-Blindnietmutter und -schrauben Hebelnietzange mit Aufziehspindel.

Pince à levier à deux mains pour écrous et goujons avec spirale de pose
Two hand operating tool for blind rivet nuts and bolts with spindle

Arbeitsbereich / Utilisation / Capacity
GO-NUT M5 - M10 / GO-BOLT M5 - M8
alle Materialien
pour tout matériau
all materials



Gewicht	Weight	Poids	1,58 kg
L x H	L x H	L x H	463 x 68 mm
Mundstücktiefe P	Mouth piece deep P	Profondeur du nez P	80 mm
Mundstückaufnahme	Mouth piece adapter	Positionneur des embouts	Ø 20 mm
Material Gehäuse	Body material	Matériau du corps	nylon
Material Hebel	Lever material	Matériau des leviers	steel
Ausrüstung	Equipment	Équipement	GO-NUT 1 x M5 - M10 GO-BOLT 1 x M5 - M8

Best.-Nr. 310 361

Drahtseilschere coupeur de fil de corde wire Rope Cutter



49,95
€/Stk./pcs.

Nouveau - New
Neu

Schneidleistung bis 12 mm
Länge 500 mm
Gewicht 1,5 kg

Best.-Nr. 310-400

Blindnietmutter Universal-E Edelstahl 1.4570/1.4303 Ecrou en acier universel-S pour rivet aveugle Blind rivet nut Universal-E Grade A2 (304)

M	s/mm	l	k	l _{1max}	ØD /mm	Best.-Nr.	€/Stk. /pcs.
M5	0,5-3,0	12,0	0,4	8,5	7,2	20200-E-M5	0,39
M6	0,5-3,0	14,0	0,4	10,0	9,6	20200-E-M6	0,44
M8	0,5-3,0	14,5	0,4	11,5	10,6	20200-E-M8	0,59
gerändelt / cranté / knurled							
M5	0,5-3,0	18,0	0,5	14,5	7,2	20200-ER-M5	0,47
M6	0,7-3,2	20,0	0,5	16,0	9,6	20200-ER-M6	0,56
M8	0,7-4,0	23,5	0,5	19,0	10,6	20200-ER-M8	0,79
M10	1,0-3,5	26,5	0,7	22,0	12,7	20200-ER-M10	1,19

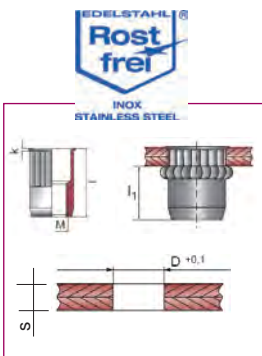

Blindnietgewindebolzen Rifbolt-E Edelstahl 1.4570/1.4303 Boulon en Inox 304 Rifbolt-E pour rivet aveugle Blind rivet bolt Rifbolt-E Inox 304

M	s/mm	l	k	l _{1max}	ØD /mm	d _k	l ₂	Best.-Nr.	€/Stk. /pcs.
M6	0,5-2,5	11,5	1,0	7,0	7,8	10	15	20202-E-M6	0,86
M8	1,0-3,0	14	1,5	9,0	9,9	12	20	20202-E-M8	1,24

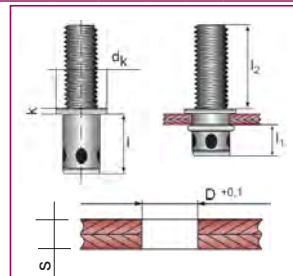

Blindnietgewindebolzen Rifbolt-S Stahl Boulon en Inox 304 Rifbolt-S pour rivet aveugle Blind rivet bolt Rifbolt-S steel

M	s/mm	l	k	l _{1max}	ØD /mm	d _k	l ₂	Best.-Nr.	€/Stk. /pcs.
M6	1,5-3,4	12	1,1	7,0	7,8	-	20	20203-S-M6	0,29
M8	1,5-3,9	15	1,2	9,0	9,9	-	20	20203-S-M8	0,44

Blindnietmutter Universal-S Stahl Ecrou en acier Universal-S pour rivet aveugle Blind rivet nut Universal-S Steel

M	s/mm	l	k	l _{1max}	ØD /mm	Best.-Nr.	€/Stk. /pcs.
M5	0,5-3,0	11,5	0,4	8,0	7	20201-S-M5	0,11
M6	0,5-3,0	13,0	0,4	10,0	8	20201-S-M6	0,14
M8	0,5-3,0	15,5	0,4	11,5	10	20201-S-M8	0,17
M10	0,5-3,0	17,5	0,4	13,0	12	20201-S-M10	0,31
gerändelt / cranté / knurled							
M5	0,5-3,0	11,5	0,4	8,0	7	20201-SR-M5	0,11
M6	0,5-3,0	13,0	0,4	10,0	8	20201-SR-M6	0,14
M8	0,5-3,0	15,5	0,4	11,5	10	20201-SR-M8	0,17
M10	0,5-3,0	17,5	0,4	13,0	12	20201-SR-M10	0,31

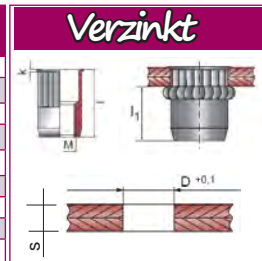

Verzinkt

Technische Daten:

Presskraft	116KN
Presskapazität	50-400 mm ²
Hub	30 mm
Ölmenge	145cc
Gewicht	7.00 kg
Koffer	Kunststoff-Box
Gewicht der Box	1.70 kg
Zubehör	-
Presseinsätze	50,70,95,120,150,185,240,300,400 mm ²

Hydraulische Presszange CYO-430

Profi-Werkzeug, einfach in der Bedienung !

Best.-Nr. 310-430



249,95
Euro

Nouveau - New
Neu

Lamellenscheiben
Disques à lamelles
Flap discs



≥ **1,29**
€/Stk./pcs.

Zirkonkorund / Corindon-zircon
Corindon zircon / Corindon-zircon Ø 115 mm,
10 Stk./pcs. in Box

Körnung /mm	Best.-Nr.	< 99 €/Stk./pcs.	> 100 €/Stk./pcs.
40	12075	1,44	1,29
60	12076	1,44	1,29
80	12077	1,44	1,29

Zirkonkorund
Corindon-zircon / Corindon zircon Ø 125 mm,
10 Stk./pcs. in Box

Körnung /mm	Best.-Nr.	< 99 €/Stk./pcs.	> 100 €/Stk./pcs.
40	12070	1,64	1,49
60	12071	1,64	1,49
80	12072	1,64	1,49



Trennscheiben
Disques à tronçonner
Cutting discs

≥ **0,69**
€/Stk./pcs.

Professional Quality!

Metall,
25 Stk./pcs. in Box

Abmessung /mm	Best.-Nr.	€/Stk./pcs.
115 x 1,0 x 22	12012-T	0,69
125 x 1,0 x 22	12022-T	0,79



Trennscheiben
Disques à tronçonner
Cutting discs

Professional Quality!

Mit DSA Zulassung
Certification DSA
With DSA approval
25 Stk./pcs. in Box

Abmessung /mm	Best.-Nr.	€/Stk./pcs.
115 x 2,5 x 22	12011	0,61
125 x 2,5 x 22	12021	0,66
180 x 3,0 x 22	12042	0,86
230 x 3,0 x 22	12051	1,17

≥ **0,61**
€/Stk./pcs.



Schruppscheiben
Disques d'affutage
Grinding discs

Professional Quality!

Mit DSA Zulassung
Certification DSA
With DSA approval
10 Stk./pcs. in Box

Abmessung /mm	Best.-Nr.	€/Stk./pcs.
115 x 6,5 x 22	12016	0,86
125 x 6,5 x 22	12026	0,92
180 x 6,0 x 22	12046	1,38
230 x 6,0 x 22	12056	2,04

≥ **0,86**
€/Stk./pcs.





≥ 4,99
€/Stk./pcs.

Edelstahl-Pflegespray Spray d'entretien pour inox Stainless steel maintenance spray



Zur Reinigung, Pflege und Schutz von matten und polierten Edelstahlflächen im Innen- und Außenbereich. Wirkt antistatisch.

Anwendungsgebiete:

1. entfernt und verhindert Fingerabdrücke
2. reinigt streifenfrei auch grössere Flächen
3. lässt behandelte Flächen wie neu wirken
4. hinterlässt einen langanhaltenden Schutzfilm, der Wasser abperlen lässt
5. verhindert das erneute Anhaften von Schmutz

Pour nettoyer et entretenir les surfaces en inox en intérieur et extérieur. Effet antistatique.

Utilisations:

1. efface et protège des traces de doigts
2. nettoie de grandes surfaces
3. surfaces lavées comme neuves
4. dépose un film protecteur sur la surface pour une longue durée
5. empêche l'adhésion de la saleté

Applications:

Used to clean and for maintenance of stainless steel surfaces indoor and outdoor. Antistatic effect.

1. removes and prevents finger prints
2. cleans larger areas
3. cleaned areas to be as new
4. leaves a protective film on surface for a long period
5. prevents dirt from re-adhering

Inhalt /ml	Best.-Nr.	€/Stk./pcs
400	25100	5,49 ≥ 12
		4,99

SAROX

Edelstahl-Beizpaste L1 Pâte décapante L1 / Pickling paste L1

L1

Speziell entwickelt für glänzende und geschliffene Edelstahloberflächen in IIIc/IIIId-Qualität.
Produit développé spécifiquement pour surfaces en inox brillantes de qualité IIIc/IIIId.
Developed specifically for shiny and IIIc/IIIId quality polished stainless steel surfaces.



nur 19,90
€/ 2 kg

Extrem geruchs- und schadstoffreduziert. Entfernt Anlauffarben, Verzunderungen, Oxide im Schweißnahtbereich und in wärmebehandelten Zonen.

Best.-Nr. 25061

Extra

Edelstahl-Beizpaste Extra Pâte décapante Extra / Pickling paste Extra

SAROX



Entfernt Anlauffarben, Verzunderungen, Oxide im Schweißnahtbereich und in wärmebehandelten Zonen.

nur 19,90
€/ 2 kg

Best.-Nr. 25060

Klebstoffe / Adhésifs / Adhesives

COSMOPLAST 500L

ein schnellhärtender 1-Komponenten-Klebstoff für die handwerkliche und industrielle Anwendung
cyan-acrylic adhesive

colle cyano-acrylique

Best.-Nr. 25116
20 ml,

2,99 €/Stk./pcs.



AK-Bond Anaerob-Klebstoff

1-Komponenten, anaerob aushärtender Kleb- und Dichtstoff speziell für Metallverbindungen.

1-component, anaerobic curing adhesives and Sealant specifically for Metal compounds.

1-composant, anaérobie durcissement des adhésifs et Mastic spécifiquement pour Les composés métalliques.

Best.-Nr. 25117
50 ml,

9,95 €/Stk./pcs.



Edelstahl-Reiniger AKBAS - C auf Zitronensäurebasis



Entfernt Flugrost und Oxide
Enlève la rouille et des oxydes
Removes rust and oxides

Best.-Nr. 25062
1000 ml,

6,99 €/Stk./pcs.

umweltfreundlich!

AK EQUIP

WS-Plast Dickschicht M 4200

Enduit épais WS-Plast M 4200 / WS-Plast Thick film epoxy paint M 4200

Langfristiger dekorativer Schutz. Direkthaftende Flüssigkunststoff-Farbe wie z.B. auf Aluminium, Kupfer, Messing, Edelstahl, frischer Feuerverzinkung, hart PVC u.v.m.

Protection décorative longue durée. Adhésion directe de la peinture. Pour aluminium, cuivre, laiton, inox, PVC épais.

Decorative protection for long period. Direct adhesive epoxy paint. Painted on Aluminium, Copper, Brass, Stainless steel, Galvanized, hard PVC



Farben / Couleurs / Colours

RAL 1013	perlweiß	RAL 7030	steingrau
RAL 1021	rapsgelb	RAL 7035	lichtgrau
RAL 2000	gelborange	RAL 8001	ockerbraun
RAL 3000	feuerrot	RAL 8014	sepiabraun
RAL 3003	rubinrot	RAL 8017	schokoladenbraun
RAL 5010	enzianblau	RAL 9002	grauweiß
RAL 6005	moosgrün	RAL 9010	reinweiß
RAL 6009	tannengrün	RAL 9016	verkehrsweiß
RAL 6010	grasgrün	0001	schmiedeschwarz
RAL 6011	resedagrün	0002	eloxalbraun
RAL 7001	silbergrau	0003	graphit EG
RAL 7016	anthrazit	0008	schwarzglimmer
RAL 7023	betongrau	DB	Farbtöne

Inhalt /Liter	Best.-Nr.	€/Liter ≤ 5 Stk./pcs.	€/Liter ≥ 6 Stk./pcs.
2,5 l	25002	14,99	14,49

Inhalt /kg	Best.-Nr.	€/kg ≤ 5 Stk./pcs.	€/kg ≥ 6 Stk./pcs.
11 kg	25004	12,99	12,49

0004 silber (RAL 9006)(A) = Aufpreisfarbton + 5,- €/l
0005 kupfer (A) = Aufpreisfarbton + 5,- €/l
0007 altkupfer (A) = Aufpreisfarbton + 5,- €/l
RAL 9007 graualuminium (A) = Aufpreisfarbton + 5,- €/l

Sondertöne: Aufpreis + 7,00 €/l
Sondertöne, die von den Standardfarbtönen abweichen, können nach RAL-Karte bzw. Mustervorlage getönt werden. Lieferumfang min. 2,5 l.

WS-Patina

Witterungsbeständig für außen und innen. Extrem ergiebig.

Patine WS.

Résistant aux intempéries, forte efficacité.

WS-Patina

Weather proof and extremely productive.



Farben / Couleurs / Colours	Best.-Nr.	€/Stk./pcs.
grün / green	25034	9,99
violett / violet	25035	9,99
gold / or / gold	25031	10,99
kupfer / cuivre / copper	25032	10,99
silber / argent / silver	25033	10,99

WS-Korrogrund

Hochwertige Zinkphosphat-Grundierung, schnell-trocknend, ergiebig. Farbtöne: grau, rotbraun

Peinture anti-rouille WS

Haute qualité, séchage rapide, forte efficacité. Couleur: gris, bordeaux

WS-Primer paint

High quality zinc phosphate primer, quick-drying, productive. Color: Gray, maroon



Best.-Nr. **25091-G** (Grau)
Best.-Nr. **25091-R** (Rotbraun)
2,5 Liter-Dose **7,45 €/l**
Best.-Nr. **25090-G** (Grau)
Best.-Nr. **25090-R** (Rotbraun)
12,5 kg Eimer **5,99 €/kg**

AK EQUIP

WS Zink-Farbe 108

- Metallisch glänzend, Silbereffekt
- guter Witterungsschutz

WS-Zink Spray 108

WS-Spray zinc 108
WS-Zinc Spray 108

WS Couleur Zinc 108

- Aspect métal, effet argent
- résistant aux intempéries



Inhalt /ml	Best.-Nr.	€/Stk./pcs
250	25080	6,99 6,49

Inhalt /ml	Best.-Nr.	€/Stk./pcs
500	25081	9,99 9,49

Inhalt /ml	Best.-Nr.	€/Stk./pcs
400	25070	5,99 5,79

WS-Verdünnung MV 751

Zum Verdünnen von WS-Plast Dickschicht, WS-Plast-Haftgrund und WS-Patinierfarbe

Diluant WS - MV 751

Diluant pour produits WS

WS-Thinner MV 751

Thinner for WS-Products



Inhalt /Liter	Best.-Nr.	€/Liter
1,0	25040	5,99
5,0	25042	5,79
10,0	25050	5,49

AK EQUIP